

# TEMPERATURE TRANSMITTERS

## SEM203 SERIES

- > UNIQUE PUSH BUTTON CALIBRATION
- > RE-RANGEABLE WITHOUT A PC
- > 10 YEAR WARRANTY
- > RTD, TC, SLIDEWIRE OR THERMISTOR INPUT
- > LED OVER-RANGE INDICATION
- > GALVANIC ISOLATION ON TC TYPES
- > DRIFT FREE LINEARISATION



### INTRODUCTION

A simple push button operation ranges and calibrates the SEM203 (4 to 20) mA temperature transmitter, eliminating the need for soldering links, potentiometers or PC's.

The SEM203 in-head transmitter incorporates the latest digital technology to ensure accurate drift free linearisation. It connects to an appropriate sensor and converts the output to a linear (4 to 20) mA output signal, providing a level of performance at a cost that was not possible with earlier analogue types.

High accuracy and stability coupled with the flexibility of reduced stock holding and the quick and easy way of bench re-ranging makes the SEM203 the ideal choice for the majority of temperature sensing requirements.

The SEM203 is linearised to comply with all common RTD sensor standards i.e. 0.00385, 0.003916 etc. all common thermocouple types and 2252  $\Omega$  and 10 k $\Omega$  YSI Thermistors, and up to 10 k $\Omega$  potentiometers.

An on board LED indicates the successful completion of the range programming and also provides an instant indication of sensor health.

### CALIBRATION PROCEDURE

1. Connect a simulator/calibrator to the input and between 8 & 30 VDC to the output of the SEM203.
2. Set the simulator to the desired temperature at 4 mA. Press and HOLD the calibration button until the LED starts to blink.
3. Set the simulator to the desired temperature at 20 mA. Press the calibration button and release. The LED continues blinking and then shuts off confirming that the unit is calibrated.

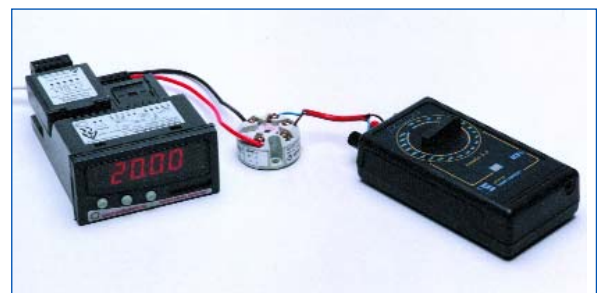

#### TYPICAL SET-UP

The above picture shows SEM203TC, DM3420 Indicator, and Thermocouple simulator.

# TEMPERATURE TRANSMITTERS

## SPECIFICATIONS @20 °C

### GENERAL

Sample Rate	500 ms per sample
Sensor Lead Length	Maximum length 3 m to maintain CE compliance
Terminals	Screw terminals
Warm-up Time	120 s to full accuracy
Display	Slow flash indicates programming mode. Full on indicates out of range sensor
Switch	Momentary push button
Calibration Period	12 months to maintain published specification.
Warranty	5 years to twice specification 10 years

### APPROVALS

EMC	BS EN 61326
-----	-------------

### ENVIRONMENTAL

Operating Temp. Range	(-20 to 80) °C
Ambient Humidity	(0 to 95) % non condensing
Ambient Storage Temp.	(-40 to 90) °C

### ENCLOSURE

Material	ABS Case (Polyurethane Encapsulated)
Flammability	UL 94 HB

### INPUT

Sensor & Ranges	SEM203P 3 wire Pt100 (Pt500 or Pt1000 to order)
Default Range	(0 to 100) °C
Accuracy	± 0.1 °C ± 0.1 % rdg (-100 °C to 500) °C ± 0.2 °C ± 0.2 % rdg (-200 °C to 850) °C
Linearisation	BS EN 60751, BS 1904 (DIN 43760) JISC 1604 (0.003916)
Input/Out Isolation	N/A
Excitation Current	1 mA maximum
Lead Resistance	10 Ω per leg
(Max. Effect)	0.02 % Full Range output/Ω (plus lead resistance mismatch)
Thermal Drift	Zero Span ± 0.01 °C/°C 0.05 %/°C
Minimum Span	5 °C

### INPUT

Sensors & Ranges	SEM203TC
SEM203-1/TC	K (-200 to 1370) °C J (-200 to 1200) °C T (-200 to 400) °C
SEM203- 2/TC	R (0 to 1760) °C S (0 to 1760) °C B (0 to 1820) °C
SEM203- 3/TC	J (-200 to 1200) °C L (-200 to 1200) °C E (-200 to 1000) °C
SEM203- 4/TC	K (-200 to 1370) °C N (0 to 1300) °C R (0 to 1760) °C

Other combinations available to special order

### Default Range

SEM203-1	K	(0 to 1000) °C
SEM203-2	R	(0 to 1600) °C
SEM203-3	J	(0 to 1000) °C
SEM203-4	K	(0 to 1000) °C

### Accuracy

Accuracy	± 0.04 % FS ± 0.04 % rdg or 0.5 °C (whichever is greater)
Linearisation	BS4937/IEC 584-1
Input/ Out Isolation	50 VDC (tested to 200 V)
Cold Junction Error	± 0.2 °C
Cold Junction Tracking	0.05 °C/°C
Cold Junction Range	(-20 to 80) °C
Thermal Drift	Zero Span ± 4 mV/°C Typical 0.01 %/°C
Minimum Span	10 °C

### INPUT

Sensors & Ranges	SEM203TH
SEM203 -1/TH	YSI 2252 Ω Type B
SEM203 -2/TH	YSI 10 kΩ Type B
Default Range	(-25 to 125) °C
Accuracy	± 0.15 °C rng (0 to 100) °C ± 0.20 °C rng (-25 to 125) °C
Input/Out Isolation	N/A
Excitation Current	2252 Ω , 240 mA, 10 KΩ, 100mA
Thermal Drift	Zero Span ± 0.0 °C/°C 0.05%/°C
Minimum Span	5 °C

### INPUT

Sensors & Ranges	SEM203W
Slidewire Potentiometer	5 kΩ, 10 kΩ
Span	(10 to 100) % Travel
Offset (4 mA o/p)	(0 to 100) % Travel
Accuracy	0.05 % Typical
Default Range	(0 to 100) % Offset (4 mA o/p)
OUTPUTS	(4 to 20) mA, 2 wire loop powered
Max. Output Range	(3.8 to 22) mA
Operating Voltage	(8 to 30) DC
Accuracy	± 5 mA
Burnout	Upscale 22 mA (downscale to order) Red programming LED comes on when temperature is outside operating range.
Thermal Drift	0.3 mA/°C
Response Time	500 ms to reach 70 % of final value
Loop Resistance	Maximum 800 R at 24 VDC
Loop Sensitivity	0.4 mA/V
Protection	Reverse connection protected

# TEMPERATURE TRANSMITTERS

## MECHANICAL DETAILS

(All dimensions in mm)

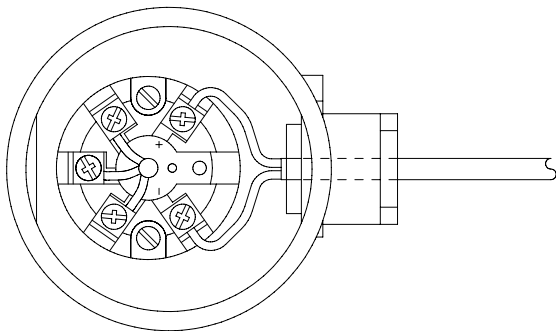
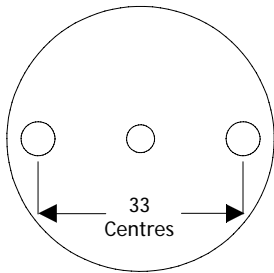
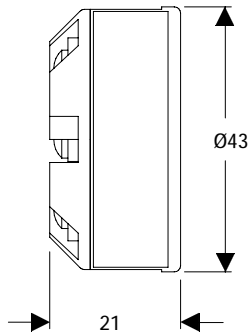

## WIRING CONNECTIONS

SEM203P

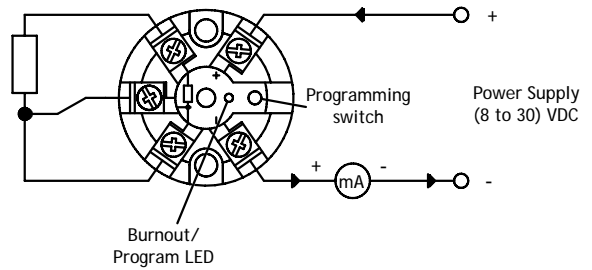

SEM203TC

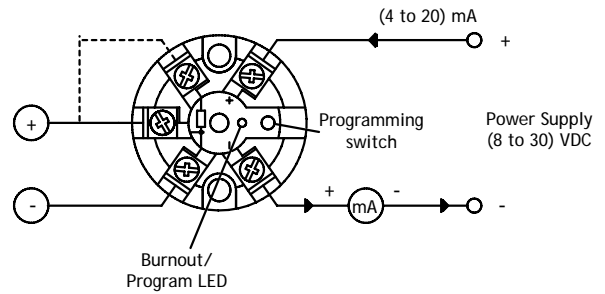

SEM203TH

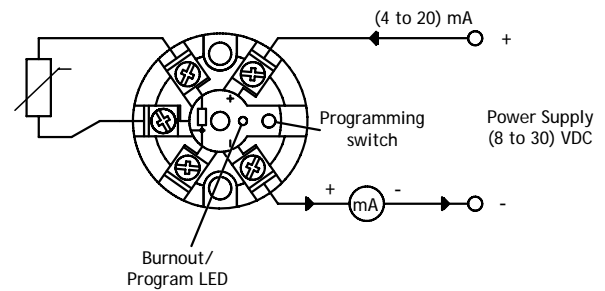

SEM203W

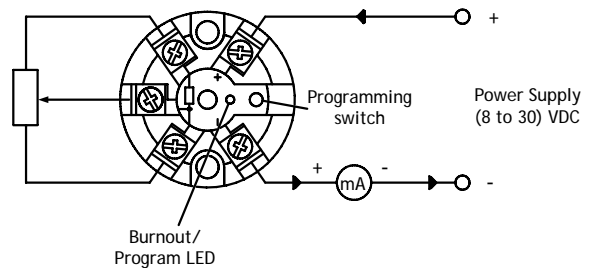

# TEMPERATURE TRANSMITTERS

## ASSOCIATED PRODUCTS:

SEM104	The SEM104 is a low cost (4 to 20) mA transmitter for use with standard Pt100 platinum resistance sensors in the size of a standard DIN terminal block.
SEM205P	SEM205P is a second generation "Smart" Head Mount temperature transmitter which accepts Pt100 temperature sensors and generates an industry standard (4 to 20) mA transmission signal.
SEM210	SEM210 is a second generation "Smart" Head Mount temperature transmitter which accepts most commonly used temperature sensors (also slide-wire sensors or mV inputs) and generates an industry standard (4 to 20) mA transmission signal.
SEM1000	Analogue signal Isolator
SEM1020	Loop Booster
SEM1100	Line powered process isolator
SEM1200	Signal Splitter
SEM1300	Power supply unit
SEM1400	Loop powered trip amplifiers
SEM1503/1504	Pt100 transmitters
SEM1500TC	Isolating TC transmitter
DM600	The DM600 series of Battery Powered Field Indicators accept either a RTD sensor or a thermocouple sensor, depending upon the model, and displays the temperature on a 4 digit LCD display.
DM700	The DM700 series is a 4 Digit LED Loop Powered Field Indicator. It is available with a choice of (4 to 20) mA, RTD or Thermocouple input.
SENSORS	A complete range of sensors and accessories are available: <ul style="list-style-type: none"><li>● Platinum resistance temperature detectors</li><li>● Thermocouples</li><li>● Thermistors</li></ul>
ACCESSORIES	DIN Rail Mounting kits are available in "Top Hat" and "G" profiles.



## ORDER CODE

SERIES	SEM203	
Pt100	P	
Pt500	P-500	
Pt1000	P-1000	
Thermocouple K, J & T	-1/TC*1	
Thermocouple R, S & B	-2/TC*1	
Thermocouple J, F & E	-3/TC*1	
Thermocouple K, N & R	-4/TC*1	
YSI 2252 $\Omega$ Type B	-1/TH	
YSI 10 K $\Omega$ Type B	-2/TC	
Slidewire 5 $\Omega$ NOM	-1/W	
Slidewire 10 K $\Omega$ NOM	-2/W	
CONFIG203*2		

### \*NOTES:

1. T/C Type selectable between three options by push buttons.
2. For special configuration, please contact the sales office.

Upscale burnout is standard, for downscale please contact the sales office