

# Temperature Monitoring Relay K8AB-TH

## Compact and Slim Relay Ideal for Temperature Alarms and Monitoring

- Excessive temperature increases can be prevented and abnormal temperatures can be monitored.
- Temperature monitoring in slim design with a width of just 22.5 mm.
- Simple function settings using DIP switch.
- Multi-input support for thermocouple or Pt100 sensor input.
- Selectable output relay: Non-fail safe/fail safe.
- Alarm status identification with LED indicator.
- CE Marking  
UL/CSA certification pending.



CE **NEW**

## Features

- This Temperature Monitoring Relay was designed specially for monitoring abnormal temperatures to prevent excessive temperature increase and to protect equipment.
- A relay capacity of 3 A at 250 VAC (resistive load) is provided. An output latch function is also supported.
- Settings can be made and functions can be selected using the DIP switch.
- Reduce the number of models by using multi-input support for thermocouple or Pt100 sensor input.

### Selecting Functions and Modes

- The following settings are provided: alarm mode (upper limit/lower limit), enable/disable latch, °C/°F, relay output non-fail safe/fail safe, setting protection.

### Terminal Wiring with Ferrules

- Wire with 2 × 2.5 mm<sup>2</sup> solid wire or 2 × 1.5 mm<sup>2</sup> wiring ferrules.

## Model Number Structure

### Model Number Legend

**K8AB-TH1** □ □ □ □  
1      2      3      4

#### 1. Basic Model

K8AB: Measuring and Monitoring Relay

#### 2. Function

TH1: Temperature Monitoring Relay

#### 3. Setting Range

- 1: Low-temperature range (0 to 399°C: setting in increments of 1°C)
- 2: High-temperature range (0 to 1800°C max.: setting in increments of 10°C)

#### 4. Output Form

S: One SPDT relay output

## Ordering Information

### List of Models

Temperature Monitoring Relay	Input type	Temperature setting range	Setting unit	Supply voltage	Model
	Thermocouple/ Pt100	0 to 399°C/°F	1°C/°F	100 to 240 VAC	K8AB-TH11S 100-240VAC
				24 VAC/VDC	K8AB-TH11S 24VAC/VDC
	Thermocouple	0 to 1,700°C 0 to 3,200°F	10°C/°F (See note.)	100 to 240 VAC	K8AB-TH12S 100-240VAC
				24 VAC/VDC	K8AB-TH12S 24VAC/VDC

**Note:** Refer to page 3 for setting ranges.

# Specifications

## ■ Ratings

Item	Power supply voltage	100 to 240 VAC 50/60 Hz	24 VAC 50/60 Hz or 24 VDC
Allowable voltage range		85% to 110% of power supply voltage	
Power consumption		5 VA max.	2 W max. (24 VDC), 4 VA max. (24 VAC)
Sensor inputs	K8AB-TH11S	Thermocouple: K, J, T, E; Platinum-resistance thermometer: Pt100	
	K8AB-TH12S	Thermocouple: K, J, T, E, B, R, S, PLII	
Output relay		One SPDT relay (3 A at 250 VAC, resistive load)	
External inputs (for latch setting)	Contact input	ON: 1 kΩ max., OFF: 100 kΩ min.	
	Non-contact input	ON residual voltage: 1.5 V max., OFF leakage current: 0.1 mA max. Leakage current: Approx. 10 mA	
Setting method		Rotary switch setting (set of three switches)	
Indicators		Power (PWR): Green LED, Relay output (ALM): Red LED	
Other functions		Alarm Mode (upper limit/lower limit), non-fail safe/fail safe selection, output latch, setting protection, temperature unit °C/°F	
Ambient operating temperature		-10 to 55°C (with no condensation or icing)	
Ambient operating humidity		Relative humidity: 25% to 85%	
Storage temperature		-25 to 65°C (with no condensation or icing)	

## ■ Characteristics

Setting accuracy		±2.0% of full scale
hysteresis width		2°C
Output relay	Resistive load	3 A at 250 VAC ( $\cos\phi = 1$ ), 3 A at 30 VDC (L/R = 0 ms)
	Inductive load	1 A at 250 VAC ( $\cos\phi = 0.4$ ), 1 A at 30 VDC (L/R = 7 ms)
	Minimum load	10 mA at 5 VDC
	Maximum contact voltage	250 VAC
	Maximum contact current	3 A AC
	Maximum switching capacity	1,500 VA
	Mechanical life	10,000,000 operations
	Electrical life	Make: 50,000 times, Break: 30,000 times
Sampling cycle		500 ms
Insulation resistance		20 MΩ (at 500 V) between charged terminals and exposed uncharged parts 20 MΩ (at 500 V) between any charged terminals (i.e., between input, output, and power supply terminals) 20 MΩ (at 500 V) between contacts (open)
Dielectric strength		2,000 VAC 50/60 Hz for 1 min between charged terminals of different polarity
Vibration resistance		Vibration of 10 to 55 Hz and acceleration of 50 m/s <sup>2</sup> for 5 min with 10 sweeps each in X, Y, and Z directions
Shock resistance		150 m/s <sup>2</sup> (100 m/s <sup>2</sup> for relay contacts) 3 times each in 6 directions in X, Y, and Z directions
Weight		130 g
Degree of protection		IP20
Memory protection		Non-volatile memory (number or writes: 200,000)
Safety Standards	Approved standards	EN 61010-1
	Application standards	EN 61326 and EN 61010-1 (pollution level 2, overvoltage category II)
EMC	EMI:	EN 61326
	Radiation Interference Field Intensity:	EN 55011 Group 1 Class A
	Noise Terminal Voltage:	EN 55011 Group 1 Class A
	EMS:	EN 61326
	Immunity ESD:	EN 61000-4-2: 4 kV contact discharge (level 2) 8 kV air discharge (level 3)
	Immunity RF:	EN 61000-4-3: 10 V/m, amplitude-modulated (80 MHz to 1 GHz, 1.4 GHz to 2 GHz) (level 3)
	Immunity Burst:	EN 61000-4-4: 2 kV power line (level 3) 2 kV output line (relay output) (level 4) 1 kV measurement line and I/O signal lines (level 4)
	Immunity Conducted Disturbance:	EN 61000-4-6: 3 V (0.15 to 80 MHz) (level 3)
	Immunity Surge:	EN 61000-4-5: 1 kV line-to-line: power line, output line (relay output) (level 2) 2 kV line-to-ground: power line, output line (relay output) (level 3)
	Commercial Frequency Immunity Magnetic Field:	EN 61000-4-8: 30 A/m (50Hz) continuous time
Immunity Voltage Dip/Interrupting:	EN 61000-4-11: 0.5 cycle, 100% (rated voltage)	
Terminal screw tightening torque		0.54 to 0.55 N·m
Crimp terminals		Two solid wires of 2.5 mm <sup>2</sup> or two ferrules of 1.5 mm <sup>2</sup> with insulation sleeves can be tightened together.
Case color		Munsell 5Y8/1 (ivory)
Case material		ABS resin (self-extinguishing resin)
Mounting		Mounted to DIN Track or with M4 screws
Dimensions		22.5 × 100 × 90 mm (W × D × H)

## ■ Setting Ranges

### K8AB-TH11S

#### Centigrade

Input	K	J	T	E	Pt100
Setting temperature range	0 ~ 399	0 ~ 399	0 ~ 399	0 ~ 399	0 ~ 399
Minimum setting increment	1°C				

#### Fahrenheit

Input	K	J	T	E	Pt100
Setting temperature range	0 ~ 399	0 ~ 399	0 ~ 399	0 ~ 399	0 ~ 399
Minimum setting increment	1°F				

### K8AB-TH12S

#### Centigrade

Input	K	J	T	E	B	R	S	PLII
Setting temperature range	0 ~ 1,300	0 ~ 850	0 ~ 400	0 ~ 600	100 ~ 1,800	0 ~ 1,700	0 ~ 1,700	0 ~ 1,300
Minimum setting increment	10°C							

#### Fahrenheit

Input	K	J	T	E	B	R	S	PLII
Setting temperature range	0 ~ 2,300	0 ~ 1,500	0 ~ 700	0 ~ 1,100	300 ~ 3,200	0 ~ 3,000	0 ~ 3,000	0 ~ 2,300
Minimum setting increment	10°F							

# Connections

## Wiring Diagrams

K8AB-TH11S

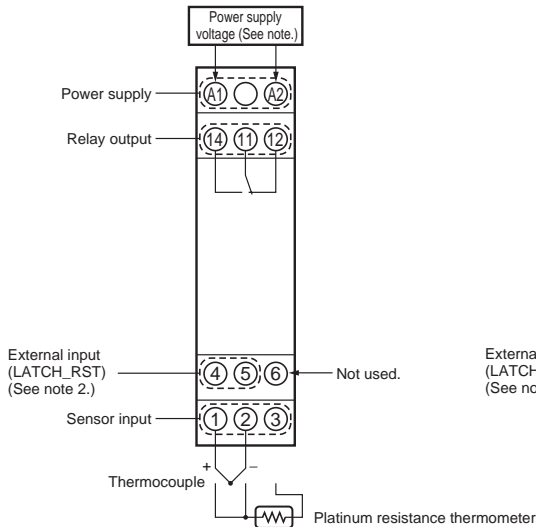

K8AB-TH12S

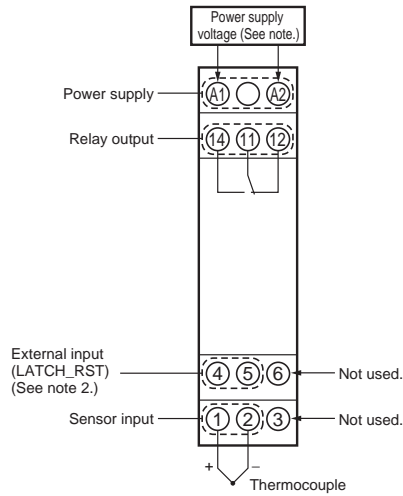

- Note:**
1. The input power supply depends on the model: 100 to 240 VAC or 24 VAC/VDC (no polarity)
  2. Wiring of the external input terminals is as shown below.

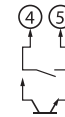

## Operation (Using the Upper-limit Alarm Mode)

### Output Latch Enabled (Default Setting: Latch Enabled)

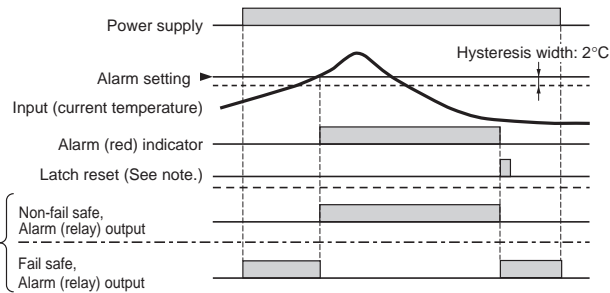

Note: The output latch is reset using the output latch reset button on the Temperature Monitoring Relay or the external input terminal.

### Output Latch Disabled

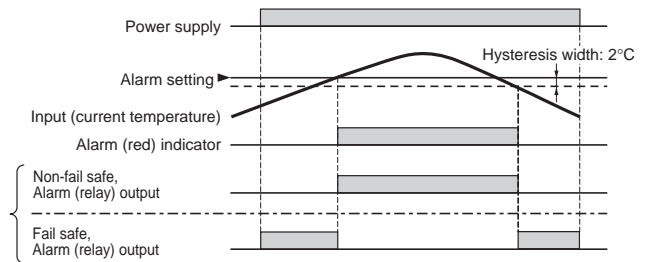

# Nomenclature

## Front Operations

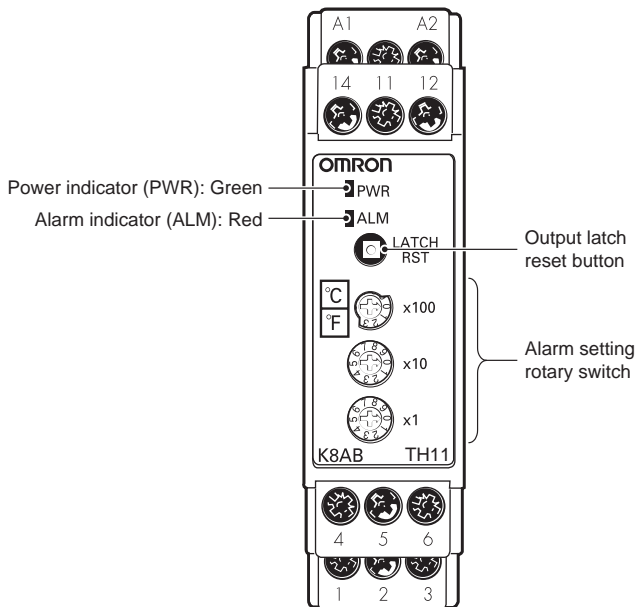

## Indicators

Item	Usage
Power indicator (PWR)	Lit: Power supply is ON. Flashing: SV protected.
Alarm indicator (ALM)	Lit: Relay is operating. Flashing: Sensor is disconnected or there is a Temperature Monitoring Relay error. (See note 1.).

## Operation Switches

Item	Usage
Output latch reset button	The output latch can be reset by pressing this button. (Enabled when latch is enabled.) (See note 2.)
Alarm setting rotary switch	Set each digit of the alarm set temperature. K8AB-TH11S: x1, x10, x100 digits K8AB-TH12S: x10, x100, x1000 digits

**Note:** 1. The ALM indicator will flash if any of the following conditions occur.

- The temperature input value exceeds the specified range.
- The temperature set value exceeds the specified range.
- There is an error in the internal circuits.

2. The SV protection will function when the latch reset button is pressed for at least 5 s.  
The power indicator will flash when the SV is protected. To release the protection, press the latch reset button again for at least 5 s.

## Alarm Setting Rotary Switch



Turn the arrow in the direction of the number to set.

## Function Setting DIP Switch

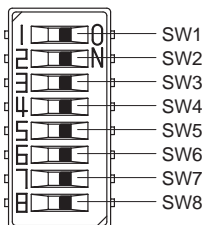

This DIP switch is provided on the side of the Temperature Monitoring Relay. (All switches are OFF for the default settings.)



SW	Function	Function		Default
		OFF	ON	
SW1	Alarm mode	OFF	Upper-limit alarm	OFF
		ON	Lower-limit alarm	
SW2	Output latch selector	OFF	Enabled	OFF
		ON	Disabled	
SW3	Operation selector: Non-fail safe/fail safe	OFF	Non-fail safe	OFF
		ON	Fail safe	
SW4	Temperature unit	OFF	°C	OFF
		ON	°F	
SW5	Input type selector	Refer to the following table.		OFF
SW6				OFF
SW7				OFF
SW8	Not used.	---		OFF

### K8AB-TH11S

SW	Sensor type							
	K	J	T	E	Pt100*	Pt100*	Pt100*	Pt100*
SW5	OFF	OFF	OFF	OFF	ON	ON	ON	ON
SW6	OFF	OFF	ON	ON	OFF	OFF	ON	ON
SW7	OFF	ON	OFF	ON	OFF	ON	OFF	ON

\* The type will be Pt100 for any of these settings.

### K8AB-TH12S

SW	Sensor type							
	K	J	T	E	B	R	S	PLII
SW5	OFF	OFF	OFF	OFF	ON	ON	ON	ON
SW6	OFF	OFF	ON	ON	OFF	OFF	ON	ON
SW7	OFF	ON	OFF	ON	OFF	ON	OFF	ON

## ■ Functions

### SV Protection

This function protects (i.e., prohibits changing) the alarm setting, operating method, and modes for the Temperature Monitoring Relay that have been set on the rotary switches and DIP switch.

The protection function is activated by pressing the output latch reset button on the Temperature Monitoring Relay for at least 5 s or by turning ON the input to the external input terminal for at least 5 s.

The power indicator will flash when the protection is activated.

The protection function can be released by pressing the output latch reset button on the Temperature Monitoring Relay for at least 5 s or by turning ON the input to the external input terminal for at least 5 s.

The power indicator will light while the protection is being reset.

## Dimensions

**Note:** All units are in millimeters unless otherwise indicated.

### ■ Temperature Monitoring Relay

K8AB-TH

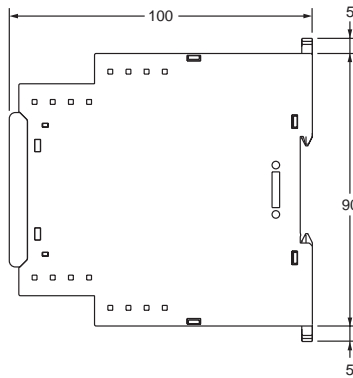
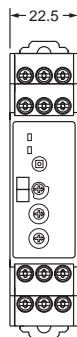
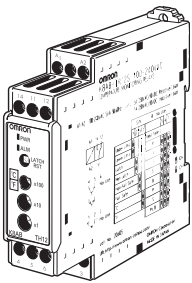

#### Mounting Hole Dimensions

Two, M4 screws or two, 4-dia screws

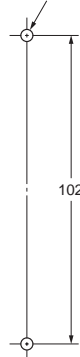

**Note:** Pull out and use the hooks when mounting using screws.

# Precautions

## CAUTION

Do not touch the terminals while power is being supplied. Doing so may occasionally result in minor injury due to electric shock.



Do not allow pieces of metal, wire clippings, or fine metallic shavings or filings from installation to enter the product. Doing so may occasionally result in electric shock, fire, or malfunction.



Do not use the product where subject to flammable or explosive gas. Otherwise, minor injury from explosion may occasionally occur.



Never disassemble, modify, or repair the product or touch any of the internal parts. Minor electric shock, fire, or malfunction may occasionally occur.



Loose screws may occasionally result in fire. Tighten terminal screws to the specified torque of 0.54 to 0.55 N-m.



Set the parameters for the Temperature Monitoring Relay so that they are appropriate for the system being monitored. If they are not appropriate, unexpected operation may occasionally result in equipment damage or accidents.

Use the following procedure to make the Temperature Monitoring Relay settings.

- Make settings for the Temperature Monitoring Relay so that they are appropriate for the system being monitored.
- Turn the power supply to the Temperature Monitoring Relay OFF before setting the switches provided on the side of the Temperature Monitoring Relay. The settings made on the switches on the side of the Temperature Monitoring Relay will be enabled when the power supply is turned ON.



A malfunction in the Temperature Monitoring Relay may occasionally make monitoring operations impossible and prevent alarm outputs, resulting in property damage to facilities and devices. Conduct periodic maintenance of the Temperature Monitoring Relay. To maintain safety in the event of malfunction of the Temperature Monitoring Relay, take appropriate safety measures, such as installing a monitoring device on a separate line.



If the output relay is used past its life expectancy, contact fusing or burning may occasionally occur. Always consider the application conditions and use the output relay within its rated load and electrical life expectancy. The life expectancy of output relays varies considerably with switching capacity and switching conditions.



## ■ Precautions for Safe Use

1. Do not use or store the Temperature Monitoring Relay in the following locations.
  - Places subject to splashing liquid or oil atmosphere
  - Places subject to direct radiant heat from heating equipment
  - Outdoors or places subject to direct sunlight
  - Places subject to dust or corrosive gas (in particular, sulfide gas and ammonia gas)
  - Places subject to intense temperature changes
  - Places subject to icing and condensation
  - Places subject to vibration and large shocks
2. Use and store the Temperature Monitoring Relay within the rated temperature and humidity ranges.
3. Mount the Temperature Monitoring Relay in the correct direction.

4. Be sure to wire properly with correct polarity of terminals.
5. Do not wire the I/O terminals incorrectly.
6. Use this Temperature Monitoring Relay within the specifications and ratings voltage and load.
7. Be sure to make the same settings for the temperature sensor type and the Temperature Monitoring Relay input type.
8. When extending the thermocouple lead wires, always use compensating conductors suitable for the type of thermocouple.
9. When extending the lead wires of the platinum resistance thermometer, be sure to use wires that have low resistance (i.e., 5 Ω max. per wire) and keep the resistance of the three lead wires the same.
10. Use the specified size of crimped terminals for wiring.
11. Do not wire the terminals that are not used.
12. Use a switch, relay, or other contact so that the power supply voltage reaches the rated voltage within one second. If the applied voltage is increased gradually, the power supply may not be reset or malfunctions may occur.
13. Design the system (e.g., control panel) to allow for the 1 second of delay required for the Temperature Monitoring Relay's output to stabilize after the power is turned ON.
14. Approximately 30 minutes is required for the correct temperature to be detected after turning the power supply to the Temperature Monitoring Relay ON. Turn the power supply ON at least 30 minutes prior to actually starting monitoring.
15. To avoid inductive noise, keep the wiring for the Temperature Monitoring Relay's terminal block away from power cables carrying high voltages or large currents. Also, do not wire power lines together with or parallel to Temperature Monitoring Relay wiring. Using shielded cables and using separate conduits or ducts is recommended.
16. Attach a surge suppressor or noise filter to peripheral devices that generate noise (in particular, motors, transformers, solenoids, magnetic coils or other equipment that have an inductance component).  
When a noise filter is used at the power supply, first check the voltage or current, and attach the noise filter as close as possible to the Temperature Monitoring Relay.  
Allow as much space as possible between the Temperature Monitoring Relay and devices that generate powerful high frequencies (high-frequency welders, high-frequency sewing machines, etc.) or surge.
17. Microwave interference may affect the Temperature Monitoring Relay. Do not use a microwave receiver near the Temperature Monitoring Relay.
18. A switch or circuit breaker should be provided close to this unit. The switch or circuit breaker should be within easy reach of the operator, and must be marked as a disconnecting means for this unit.
19. Do not use paint thinner or similar chemical to clean with. Use standard grade alcohol.
20. Use tools when separating parts for disposal. Contact with the sharp internal parts may cause injury.
21. Install the Temperature Monitoring Relay inside another device.

# Warranty and Application Considerations

## Read and Understand this Catalog

Please read and understand this catalog before purchasing the products. Please consult your OMRON representative if you have any questions or comments.

## Warranty and Limitations of Liability

### WARRANTY

OMRON's exclusive warranty is that the products are free from defects in materials and workmanship for a period of one year (or other period if specified) from date of sale by OMRON.

OMRON MAKES NO WARRANTY OR REPRESENTATION, EXPRESS OR IMPLIED, REGARDING NON-INFRINGEMENT, MERCHANTABILITY, OR FITNESS FOR PARTICULAR PURPOSE OF THE PRODUCTS. ANY BUYER OR USER ACKNOWLEDGES THAT THE BUYER OR USER ALONE HAS DETERMINED THAT THE PRODUCTS WILL SUITABLY MEET THE REQUIREMENTS OF THEIR INTENDED USE. OMRON DISCLAIMS ALL OTHER WARRANTIES, EXPRESS OR IMPLIED.

### LIMITATIONS OF LIABILITY

OMRON SHALL NOT BE RESPONSIBLE FOR SPECIAL, INDIRECT, OR CONSEQUENTIAL DAMAGES, LOSS OF PROFITS, OR COMMERCIAL LOSS IN ANY WAY CONNECTED WITH THE PRODUCTS, WHETHER SUCH CLAIM IS BASED ON CONTRACT, WARRANTY, NEGLIGENCE, OR STRICT LIABILITY.

In no event shall the responsibility of OMRON for any act exceed the individual price of the product on which liability is asserted.

IN NO EVENT SHALL OMRON BE RESPONSIBLE FOR WARRANTY, REPAIR, OR OTHER CLAIMS REGARDING THE PRODUCTS UNLESS OMRON'S ANALYSIS CONFIRMS THAT THE PRODUCTS WERE PROPERLY HANDLED, STORED, INSTALLED, AND MAINTAINED AND NOT SUBJECT TO CONTAMINATION, ABUSE, MISUSE, OR INAPPROPRIATE MODIFICATION OR REPAIR.

## Application Considerations

### SUITABILITY FOR USE

OMRON shall not be responsible for conformity with any standards, codes, or regulations that apply to the combination of products in the customer's application or use of the products.

Take all necessary steps to determine the suitability of the product for the systems, machines, and equipment with which it will be used.

Know and observe all prohibitions of use applicable to this product.

NEVER USE THE PRODUCTS FOR AN APPLICATION INVOLVING SERIOUS RISK TO LIFE OR PROPERTY WITHOUT ENSURING THAT THE SYSTEM AS A WHOLE HAS BEEN DESIGNED TO ADDRESS THE RISKS, AND THAT THE OMRON PRODUCTS ARE PROPERLY RATED AND INSTALLED FOR THE INTENDED USE WITHIN THE OVERALL EQUIPMENT OR SYSTEM.

## Disclaimers

### PERFORMANCE DATA

Performance data given in this catalog is provided as a guide for the user in determining suitability and does not constitute a warranty. It may represent the result of OMRON's test conditions, and the users must correlate it to actual application requirements. Actual performance is subject to the OMRON *Warranty and Limitations of Liability*.

### CHANGE IN SPECIFICATIONS

Product specifications and accessories may be changed at any time based on improvements and other reasons. Consult with your OMRON representative at any time to confirm actual specifications of purchased product.

### DIMENSIONS AND WEIGHTS

Dimensions and weights are nominal and are not to be used for manufacturing purposes, even when tolerances are shown.

**ALL DIMENSIONS SHOWN ARE IN MILLIMETERS.**

To convert millimeters into inches, multiply by 0.03937. To convert grams into ounces, multiply by 0.03527.

Cat. No. N150-E1-01 **In the interest of product improvement, specifications are subject to change without notice.**

## OMRON Corporation

Industrial Automation Company

Control Devices Division H.Q.

Analog Controller Division

Shiokoji Horikawa, Shimogyo-ku,

Kyoto, 600-8530 Japan

Tel: (81)75-344-7080/Fax: (81)75-344-7189



**Ph: 03 5278 8222 Fax: 03 5278 9761**  
 65 Douro Street, North Geelong VIC 3215  
[www.factorycontrols.com.au](http://www.factorycontrols.com.au)