

## Miniature Basic Switch

# V

### Reliable Basic Switches in a Wide Variation

- Wide variation of best-selling microswitches with switching currents of 10 to 21 A.
- Can be used for interrupting current when doors are opened or closed.
- Available in two types of cases: thermoplastic resin and thermosetting resin.

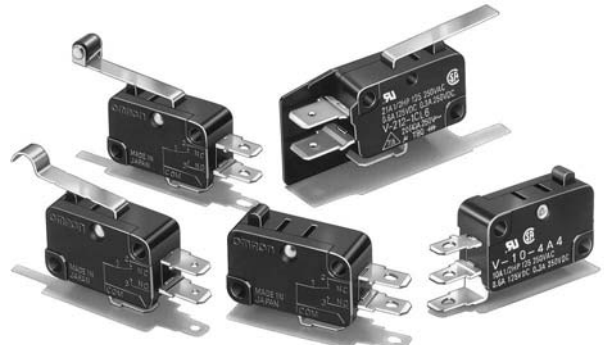

### Ordering Information

#### ■ Model Number Legend

V-□□□-□□□□-□  
 1 2 3 4 5 6 7 8

#### 1. Ratings

- 21: 21 A at 250 VAC
- 16: 16 A at 250 VAC
- 15: 15 A at 250 VAC
- 11: 11 A at 250 VAC
- 10: 10 A at 250 VAC

#### 2. Contact Gap

- None: 1 mm (F gap)
- G: 0.5 mm (G gap) (for remodelling)

#### 3. Actuator

- None: Pin plunger
- 1: Short hinge lever
- 2: Hinge lever
- 3: Long hinge lever
- 4: Simulated roller lever
- 5: Short hinge roller lever
- 6: Hinge roller lever

#### 4. Contact Form

- 1: SPDT (COM bottom terminal, double-throw)
- 2: SPST-NC (COM bottom terminal, normally closed)
- 3: SPST-NO (COM bottom terminal, normally open)
- 4: SPDT (COM side terminal, double-throw)
- 5: SPST-NC (COM side terminal, normally closed)
- 6: SPST-NO (COM side terminal, normally open)

#### 5. Terminals

- A: Solder/quick-connect terminal (#187)
- C2: Quick-connect terminal (#187)
- C: Quick-connect terminal (#250)
- B: Screw terminal

#### 6. Barrier (Models with Thermoplastic Case Only)

- None: Without barrier
- R: Right-hand barrier
- L: Left-hand barrier

#### 7. Operating Force max.

- 6: 3.92 N {400 gf}
- 5: 1.96 N {200 gf}
- 4: 0.98 N {100 gf}

**Note:** These values are for the pin plunger models.

#### 8. Special Purpose (Models with Thermosetting Case Only)

- T: Heat-resistive



Ph: 03 5278 8222 Fax: 03 5278 9761  
 65 Douro Street, North Geelong VIC 3215  
[www.factorycontrols.com.au](http://www.factorycontrols.com.au)

## ■ Combinations of Available Terminals

Terminal				Thermoplastic case				Thermosetting case					
				Model		V-21	V-16		V-11	V-15		V-10	
				Rated current	OF	21 A	16 A		11 A	15 A		10 A	
COM terminal position	Insulation barrier	Heat resistance	Terminal symbol	3.92 N {400 gf}	3.92 N {400 gf}	1.96 N {200 gf}	0.98 N {100 gf}	3.92 N {400 gf}	1.96 N {200 gf}	1.96 N {200 gf}	0.98 N {100 gf}		
Bottom	No	Standard (80°C)	Solder/Quick-connect terminal (#187) (A)	---	Semi-standard	Standard	Standard	Semi-standard	Standard	Standard	Standard		
			Quick-connect terminal (#187) (C2)	---	Semi-standard	Standard	Standard	Semi-standard	Standard	Standard	Standard		
			Quick-connect terminal (#250) (C)	Standard	Semi-standard	Standard	Standard	Semi-standard	Semi-standard	Semi-standard	Semi-standard		
			Screw terminal (B)	---	---	---	Semi-standard (1.96 N)	Semi-standard	Standard	Standard	Standard		
		Heat resistant (150°C)	Solder/Quick-connect terminal (#187) (A)	---	---	---	---	Semi-standard	Standard	Standard	Standard		
			Quick-connect terminal (#187) (C2)	---	---	---	---	Semi-standard	Semi-standard	Semi-standard	Semi-standard		
			Quick-connect terminal (#250) (C)	---	---	---	---	---	---	---	---		
			Screw terminal (B)	---	---	---	---	---	---	---	---		
	Yes	Standard (80°C)	Solder/Quick-connect terminal (#187) (A)	---	Semi-standard	Standard	---	---	---	---			
			Quick-connect terminal (#187) (C2)	---	Semi-standard	Standard	---	---	---	---			
			Quick-connect terminal (#250) (C)	Standard	Semi-standard	Standard	---	---	---	---			
			Screw terminal (B)	---	---	---	---	---	---	---			
Side	No	Standard (80°C)	Solder/Quick-connect terminal (#187) (A)	---	---	---	---	Semi-standard	Standard	Standard	Standard		
			Quick-connect terminal (#187) (C2)	---	---	---	---	Semi-standard	Semi-standard	Semi-standard	Semi-standard		
			Quick-connect terminal (#250) (C)	Semi-standard	---	---	---	---	---	---	---		







Consult OMRON for standard approvals of models.

## ■ List of Models

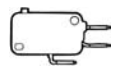
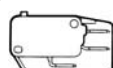
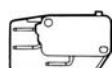







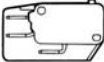

### General-purpose Models

(Only standard combinations of terminal availability are shown.)







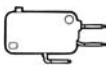

#### Thermoplastic Case

Actuator	COM terminal position	Contact form	Terminals (see note)	21 A (OF: 3.92 N {400 gf})			
				Without barrier	Right-hand barrier	Left-hand barrier	
Pin plunger 	Bottom	SPDT	C				
				V-21-1C6	V-21-1CR6	V-21-1CL6	
				V-21-2C6	V-21-2CR6	V-21-2CL6	
Short hinge lever 		SPDT-NC		SPDT	V-21-3C6	V-21-3CR6	V-21-3CL6
					V-211-1C6	V-211-1CR6	V-211-1CL6
					V-212-1C6	V-212-1CR6	V-212-1CL6
Hinge lever 		SPDT		SPDT	V-213-1C6	V-213-1CR6	V-213-1CL6
Long hinge lever 					V-214-1C6	V-214-1CR6	V-214-1CL6
Simulated roller lever 					V-215-1C6	V-215-1CR6	V-215-1CL6
Short hinge roller lever 	SPDT	SPDT	V-216-1C6	V-216-1CR6	V-216-1CL6		
Hinge roller lever 			V-216-1C6	V-216-1CR6	V-216-1CL6		

Note: C: Quick-connect terminals (#250)

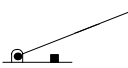
Actuator	COM terminal position	Contact form	Terminals (see note)	16 A (OF: 1.96 N {200 gf})		
				Without barrier 	Right-hand barrier 	Left-hand barrier 
Pin plunger 	Bottom	SPDT	A	V-16-1A5	V-16-1AR5	V-16-1AL5
			C2	V-16-1C25	V-16-1C2R5	V-16-1C2L5
			C	V-16-1C5	---	---
		SPST-NC	A	V-16-2A5	V-16-2AR5	V-16-2AL5
			C2	V-16-2C25	V-16-2C2R5	V-16-2C2L5
			C	V-16-2C5	---	---
		SPST-NO	A	V-16-3A5	V-16-3AR5	V-16-3AL5
			C2	V-16-3C25	V-16-3C2R5	V-16-3C2L5
			C	V-16-3C5	---	---
Short hinge lever 	Bottom	SPDT	A	V-161-1A5	V-161-1AR5	V-161-1AL5
C2			V-161-1C25	V-161-1C2R5	V-161-1C2L5	
C			V-161-1C5	---	---	
Hinge lever 		A	V-162-1A5	V-162-1AR5	V-162-1AL5	
		C2	V-162-1C25	V-162-1C2R5	V-162-1C2L5	
		C	V-162-1C5	---	---	
Long hinge lever 		A	V-163-1A5	V-163-1AR5	V-163-1AL5	
		C2	V-163-1C25	V-163-1C2R5	V-163-1C2L5	
		C	V-163-1C5	---	---	
Simulated roller lever 		A	V-164-1A5	V-164-1AR5	V-164-1AL5	
		C2	V-164-1C25	V-164-1C2R5	V-164-1C2L5	
		C	V-164-1C5	---	---	
Short hinge roller lever 		A	V-165-1A5	V-165-1AR5	V-165-1AL5	
		C2	V-165-1C25	V-165-1C2R5	V-165-1C2L5	
		C	V-165-1C5	---	---	
Hinge roller lever 		A	V-166-1A5	V-166-1AR5	V-166-1AL5	
		C2	V-166-1C25	V-166-1C2R5	V-166-1C2L5	
		C	V-166-1C5	---	---	

**Note:** A: Solder/quick-connect terminals (#187)  
 C2: Quick-connect terminals (#187)  
 C: Quick-connect terminals (#250)





Actuator	COM terminal position	Contact form	Terminals (see note)	11 A (OF: 0.98 N {100 gf})
				Without barrier 
Pin plunger 	Bottom	SPDT	A	V-11-1A4
			C2	V-11-1C24
			C	V-11-1C4
Short hinge lever 			A	V-111-1A4
			C2	V-111-1C24
			C	V-111-1C4
Hinge lever 			A	V-112-1A4
			C2	V-112-1C24
			C	V-112-1C4
Long hinge lever 			A	V-113-1A4
			C2	V-113-1C24
			C	V-113-1C4
Simulated roller lever 	A	V-114-1A4		
	C2	V-114-1C24		
	C	V-114-1C4		
Short hinge roller lever 	A	V-115-1A4		
	C2	V-115-1C24		
	C	V-115-1C4		
Hinge roller lever 	A	V-116-1A4		
	C2	V-116-1C24		
	C	V-116-1C4		

**Note:** A: Solder/quick-connect terminals (#187)

C2: Quick-connect terminals (#187)



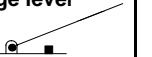
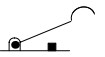



C: Quick-connect terminals (#250)

**Thermosetting Case**

Actuator	COM terminal position	Contact form	Terminals (see note 1)	15 A	10 A	
				OF: 1.96 N {200 gf}	OF: 1.96 N {200 gf}	OF: 0.98 N {100 gf}
<b>Pin plunger</b> 	Bottom	SPDT	A	V-15-1A5	V-10-1A5	V-10-1A4
			C2	V-15-1C25	V-10-1C25	V-10-1C24
			B	V-15-1B5	V-10-1B5	V-10-1B4
		SPST-NC	A	V-15-2A5	V-10-2A5	V-10-2A4
			C2	V-15-2C25	V-10-2C25	V-10-2C24
			B	V-15-2B5	V-10-2B5	V-10-2B4
		SPST-NO	A	V-15-3A5	V-10-3A5	V-10-3A4
			C2	V-15-3C25	V-10-3C25	V-10-3C24
			B	V-15-3B5	V-10-3B5	V-10-3B4
Side	SPDT	A	V-15-4A5	V-10-4A5	V-10-4A4	
		C2	V-15-5A5	V-10-5A5	V-10-5A4	
		B	V-15-6A5	V-10-6A5	V-10-6A4	
<b>Short hinge lever</b> 	Bottom	SPDT	A	V-151-1A5	V-101-1A5	V-101-1A4
			C2	V-151-1C25	V-101-1C25	V-101-1C24
			B	V-151-1B5	V-101-1B5	V-101-1B4
<b>Hinge lever</b> 			A	V-152-1A5	V-102-1A5	V-102-1A4
			C2	V-152-1C25	V-102-1C25	V-102-1C24
			B	V-152-1B5	V-102-1B5	V-102-1B4
<b>Long hinge lever</b> 			A	V-153-1A5	V-103-1A5	V-103-1A4
			C2	V-153-1C25	V-103-1C25	V-103-1C24
			B	V-153-1B5	V-103-1B5	V-103-1B4
<b>Simulated roller lever</b> 			A	V-154-1A5	V-104-1A5	V-104-1A4
			C2	V-154-1C25	V-104-1C25	V-104-1C24
			B	V-154-1B5	V-104-1B5	V-104-1B4
<b>Short hinge roller lever</b> 			A	V-155-1A5	V-105-1A5	V-105-1A4
			C2	V-155-1C25	V-105-1C25	V-105-1C24
			B	V-155-1B5	V-105-1B5	V-105-1B4
<b>Hinge roller lever</b> 			A	V-156-1A5	V-106-1A5	V-106-1A4
			C2	V-156-1C25	V-106-1C25	V-106-1C24
			B	V-156-1B5	V-106-1B5	V-106-1B4

- Note:**
1. A: Solder/quick-connect terminals (#187)  
 C2: Quick-connect terminals (#187)  
 B: Screw terminals
  2. OF values shown in the table are for the pin plunger models.

## Heat Resistant Models (Up to 150°C)

Actuator	COM terminal position	Contact specifications	Terminal specification	15 A	10 A
				OF: 1.96 N {200 gf}	OF: 0.98 N {100 gf}
Pin plunger 	Bottom	SPDT	Solder/Quick-connect terminal (#187) (A)	V-15-1A5-T	V-10-1A4-T
Short hinge lever 				V-151-1A5-T	V-101-1A4-T
Hinge lever 				V-152-1A5-T	V-102-1A4-T
Long hinge lever 				V-153-1A5-T	V-103-1A4-T
Simulated roller lever 				V-154-1A5-T	V-104-1A4-T
Short hinge roller lever 				V-155-1A5-T	V-105-1A4-T
Hinge roller lever 				V-156-1A5-T	V-106-1A4-T

## ■ Barrier (V-21 and V-16 Models Only)

Right-hand Barrier

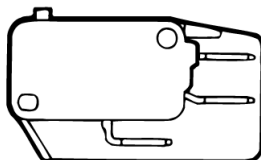

Left-hand Barrier

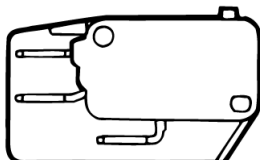

# Specifications

## ■ Ratings

Type	Rated voltage	Non-inductive load				Inductive load			
		Resistive load		Lamp load		Inductive load		Motor load	
		NC	NO	NC	NO	NC	NO	NC	NO
V-21	250 VAC	21 A		3 A		12 A		4 A	
	8 VDC	21 A		5 A		12 A		7 A	
	30 VDC	14 A		5 A		12 A		5 A	
	125 VDC	0.6 A		0.1 A		0.6 A		0.1 A	
	250 VDC	0.3 A		0.05 A		0.3 A		0.05 A	
V-16	250 VAC	16 A		2 A		10 A		3 A	
	8 VDC	16 A		4 A		10 A		6 A	
	30 VDC	10 A		4 A		10 A		4 A	
	125 VDC	0.6 A		0.1 A		0.6 A		0.1 A	
	250 VDC	0.3 A		0.05 A		0.3 A		0.05 A	
V-15	250 VAC	15 A		2 A		10 A		3 A	
	8 VDC	15 A		4 A		10 A		6 A	
	30 VDC	10 A		4 A		10 A		4 A	
	125 VDC	0.6 A		0.1 A		0.6 A		0.1 A	
	250 VDC	0.3 A		0.05 A		0.3 A		0.05 A	
V-11	250 VAC	11 A		1.5 A		6 A		2 A	
	8 VDC	11 A		3 A		6 A		3 A	
	30 VDC	6 A		3 A		6 A		3 A	
	125 VDC	0.6 A		0.1 A		0.6 A		0.1 A	
	250 VDC	0.3 A		0.05 A		0.3 A		0.05 A	
V-10	250 VAC	10 A		1.5 A		6 A		2 A	
	8 VDC	10 A		3 A		6 A		3 A	
	30 VDC	6 A		3 A		6 A		3 A	
	125 VDC	0.6 A		0.1 A		0.6 A		0.1 A	
	250 VDC	0.3 A		0.05 A		0.3 A		0.05 A	

- Note:**
- The above current values are the normal current values of models with a contact gap of 1 mm (gap F), which vary with the normal current values of models with a contact gap of 0.5 mm (gap G).
  - Inductive load has a power factor of 0.4 min. (AC) and a time constant of 7 ms max. (DC).
  - Lamp load has an inrush current of 10 times the steady-state current.
  - Motor load has an inrush current of 6 times the steady-state current.
  - The ratings values apply under the following test conditions:  
 Ambient temperature: 20±2°C  
 Ambient humidity: 65±5%  
 Operating frequency: 60 operations/min

## ■ Characteristics

<b>Operating speed</b>	0.1 mm to 1 m/s (at pin plunger models)
<b>Operating frequency</b>	Mechanical: 600 operations/min Electrical: 60 operations/min
<b>Insulation resistance</b>	100 MΩ min. (at 500 VDC)
<b>Contact resistance</b>	15 mΩ max. (initial value)
<b>Dielectric strength</b>	1,000 VAC, 50/60 Hz for 1 min between terminals of the same polarity V-21, V-16, and V-11 models: 2,000 VAC, 50/60 Hz for 1 min between current-carrying metal parts and ground, and between each terminal and non-current-carrying metal parts (see note 1) V-15 and V-10 models: 1,500 VAC, 50/60 Hz for 1 min between current-carrying metal parts and ground, and between each terminal and non-current-carrying metal parts (see note 1)
<b>Vibration resistance (see note 2)</b>	Malfunction: 10 to 55 Hz, 1.5-mm double amplitude
<b>Shock resistance (see note 2)</b>	Destruction: 1,000 m/s <sup>2</sup> {approx. 100G} max. Malfunction: V-21/V-16/V-15: 300 m/s <sup>2</sup> {approx. 30G} max. V-11/V-10: 200 m/s <sup>2</sup> {approx. 20G} max.
<b>Life expectancy (see note 3)</b>	Mechanical: 50,000,000 operations min. Electrical: V-21/V-16/V-15: 100,000 operations min. (V-15 heat resistive: 20,000 operation min.) V-11/V-10: 300,000 operations min. (V-10 heat resistive: 50,000 operation min.)
<b>Degree of protection</b>	IP00
<b>Degree of protection against electric shock</b>	Class I
<b>Proof tracking index (PTI)</b>	175
<b>Ambient temperature</b>	Operating: -25°C to 80°C (at ambient humidity of 60% max.) (with no icing) -25°C to 150°C for heat-resistive model (at ambient humidity of 60% max.) (with no icing)
<b>Ambient humidity</b>	Operating: 85% max. (for 5°C to 35°C)
<b>Weight</b>	Approx. 6.2 g (pin plunger model)

- Note:**
1. The dielectric strength values shown in the table are for models with a Separator.
  2. For the pin plunger models, the above values apply for use at both the free position and total travel position. For the lever models, they apply at the total travel position.
  3. For testing conditions, contact your OMRON sales representative.

## ■ Approved Standards

**UL1054 (File No. E41515) CSA C22.2 No.55 (File No. LR21642)**  
(Standard Ratings Only is listed.)

Rated voltage	V-21	V-16	V-15	V-11	V-10
125 VAC	21 A, 1/2 HP	16 A, 1/2 HP	15 A, 1/2 HP	11 A, 1/3 HP	10 A, 1/3 HP
250 VAC	21 A, 1/2 HP	16 A, 1/2 HP	15 A, 1/2 HP	11 A, 1/3 HP	10 A, 1/3 HP
125 VDC	0.6 A	0.6 A	0.6 A	0.6 A	0.6 A
250 VDC	0.3 A	0.3 A	0.3 A	0.3 A	0.3 A

### VDE, EN61058-1 (File No. 129608)

Rated voltage	V-21	V-16	V-11
250 VAC	20 (4) A	16 (4) A	11 (3) A

Testing conditions: 50,000 operations, T105 (0°C to 105°C)

### TÜV Rheinland EN61058-1 (File No. T9451451)

Rated voltage	V-15	V-10
250 VAC	15 A	10 A
250 VDC	0.3 A	0.3 A

Testing conditions: 5E4 (50,000 operations), T105 (0°C to 105°C)

■ **Contact Specifications**

Item		V-21	V-16	V-15	V-11	V-10
Contact	Specification	Rivet				
	Material	Silver alloy			Silver	
	Gap (standard value)	1 mm (F gap) or 0.5 mm (G gap)				
Inrush current	NC	50 A max.	40 A max.	36 A max.	24 A max.	
	NO					
Minimum applicable load		160 mA at 5 VDC				

■ **Contact Form**

**SPDT**

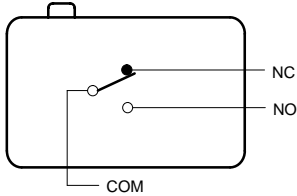

**SPST-NC**

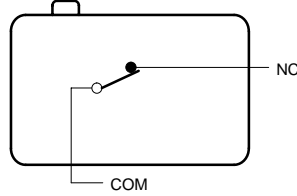

**SPST-NO**

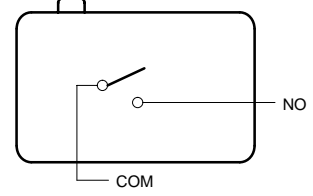

**Engineering Data**

**Mechanical Life Expectancy (Pin Plunger)**

V-21/-16/-15/-10

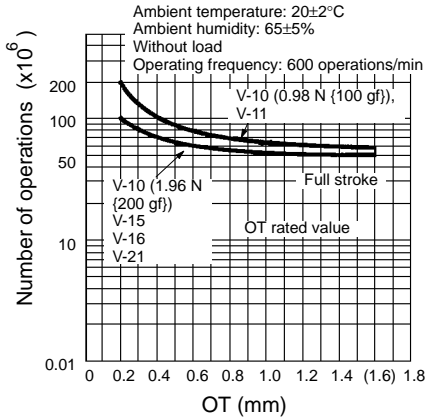

**Electrical Life Expectancy**

V-21/-16/-15

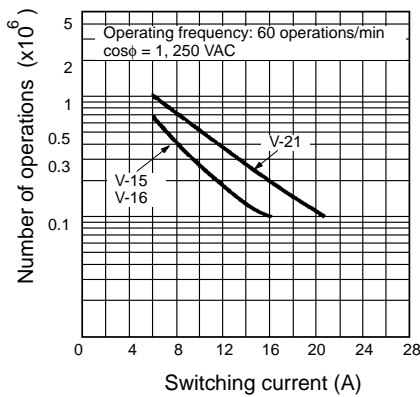

V-11/-10

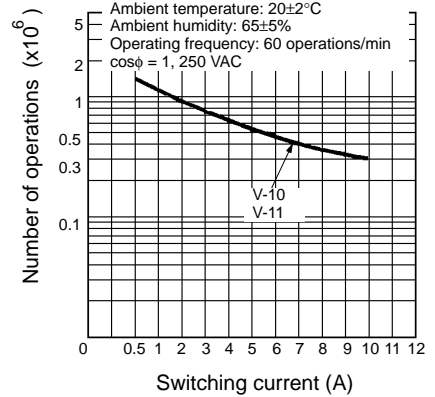

# Dimensions

## ■ Terminals

- Note:**
- All units are in millimeters unless otherwise indicated.
  - The following is for the SPDT contact specifications. Two terminals will be available for SPST-NO or SPST-NC contact specifications. For terminal positions, refer to the above *Contact Form*.
  - Right-angle PCB terminal type is available  
 D5 type: Pins at right angles, to the right.  
 D6 type: Pins at right angles, to the left.  
 Drawings will be provided if requested.

Terminal type	Solder/Quick-connect Terminal (#187) (A)	Quick-connect Terminal (#187) (C2)	Quick-connect Terminal (#250) (C)	Screw Terminal (B)
COM bottom position	<p>Three, solder/quick-connect terminals (#187)</p>	<p>Three, quick-connect terminals (#187)</p>	<p>Three, quick-connect terminals (#250)</p>	<p>Three, #M3 x 0.5 x 3.2 Phillips screw washer</p>
COM side position				---
Terminal dimensions	<p><b>Note:</b> Indicates the length to the center of the 1.6-dia. holes</p>			---

## ■ Mounting Holes

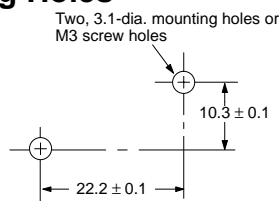

## ■ Dimensions and Operating Characteristics

**Note:** 1. All units are in millimeters unless otherwise indicated.

2. Unless otherwise specified, a tolerance of  $\pm 0.4$  mm applies to all dimensions.

3. The following illustrations and drawings are for quick-connect terminals (#250) (terminals C). V models with a switching current of 16 A or 11 A incorporates terminals A and C2. These models are different from #250 models in terminal size only. Terminals A, C2, and side common terminals are omitted from the following drawings. Refer to *Kinds of Terminals* on page 107 for these terminals.

4. The □ in the model number is for the terminal code.

5. The operating characteristics are for operation in the A direction (▼).

### Pin Plunger

(Without Barrier)

V-21-1□6

V-16-1□5

V-11-1□4

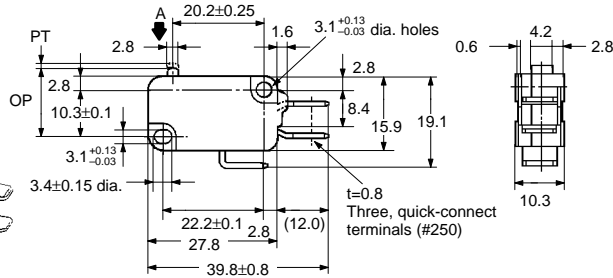
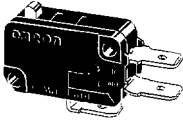

(With Right-hand Barrier)

V-21-1□R6

V-16-1□R5

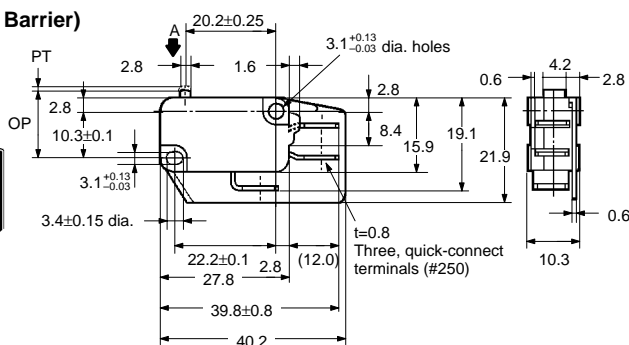
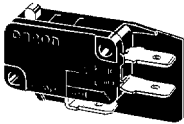

(With Left-hand Barrier)

V-21-1□L6

V-16-1□L5

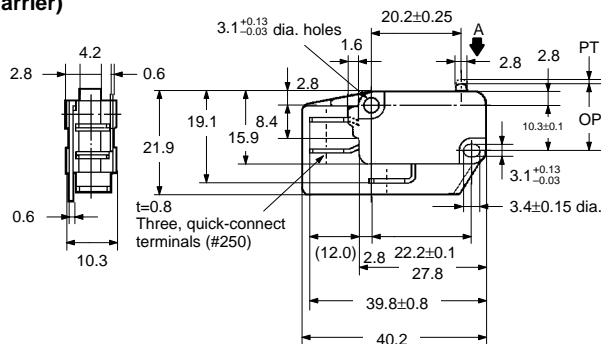
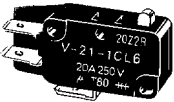

Model	V-21-1□6	V-16-1□5
OF max.	3.92 N {400 gf}	1.96 N {200 gf}
RF min.	0.78 N {80 gf}	0.49 N {50 gf}
PT max.	1.2 mm	
OT min.	1.0 mm	
MD max.	0.4 mm	
OP	14.7±0.4 mm	

Model	V-11-1□4	V-11-1□5
OF max.	0.98 N {100 gf}	1.96 N {200 gf}
RF min.	0.20 N {20 gf}	0.49 N {50 gf}
PT max.	1.2 mm	
OT min.	1.0 mm	
MD max.	0.4 mm	
OP	14.7±0.4 mm	

### Short Hinge Lever

V-211-1□6  
V-161-1□5  
V-111-1□4

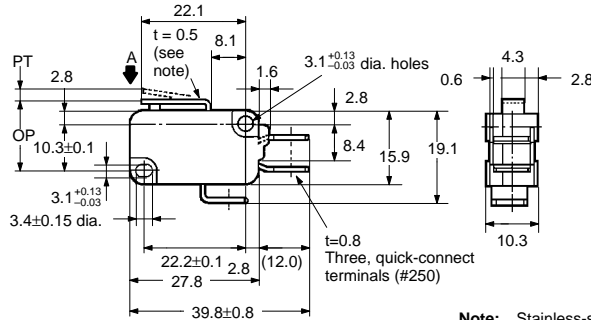
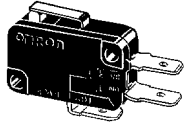

Note: Stainless-steel lever

Model	V-211-1□6	V-161-1□5
OF max.	3.92 N {400 gf}	1.96 N {200 gf}
RF min.	0.49 N {50 gf}	0.49 N {50 gf}
PT max.	1.6 mm	
OT min.	0.8 mm	
MD max.	0.6 mm	
OP	15.2±0.5 mm	

Model	V-111-1□4
OF max.	0.98 N {100 gf}
RF min.	0.15 N {15 gf}
PT max.	1.6 mm
OT min.	0.8 mm
MD max.	0.6 mm
OP	15.2±0.5 mm

### Hinge Lever

V-212-1□6  
V-162-1□5  
V-112-1□4

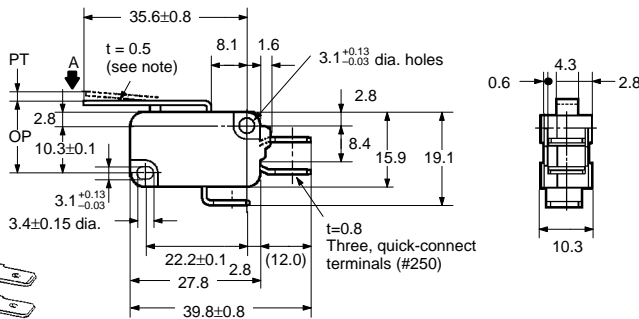
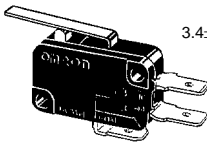

Note: Stainless-steel lever

Model	V-212-1□6	V-162-1□5
OF max.	2.45 N {250 gf}	1.23 N {125 gf}
RF min.	0.25 N {25 gf}	0.14 N {14 gf}
PT max.	4.0 mm	
OT min.	1.6 mm	
MD max.	1.5 mm	
OP	15.2±1.2 mm	

Model	V-112-1□4
OF max.	0.59 N {60 gf}
RF min.	0.06 N {6 gf}
PT max.	4.0 mm
OT min.	1.6 mm
MD max.	1.5 mm
OP	15.2±1.2 mm

### Long Hinge Lever

V-213-1□6  
V-163-1□5  
V-113-1□4

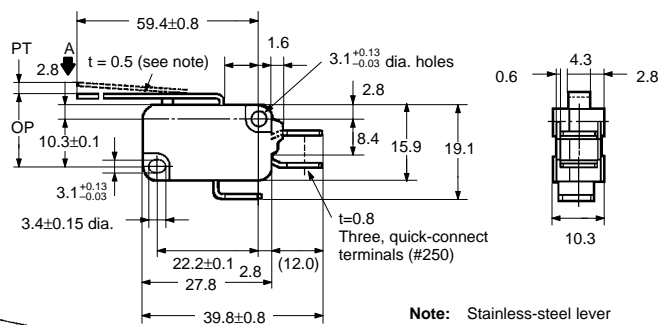
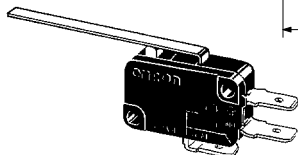

Note: Stainless-steel lever

Model	V-213-1□6	V-163-1□5
OF max.	1.27 N {130 gf}	0.69 N {70 gf}
RF min.	0.12 N {12 gf}	0.06 N {6 gf}
PT max.	9.0 mm	
OT min.	2.0 mm	
MD max.	2.8 mm	
OP	15.2 <sup>+2.6</sup> <sub>-3.2</sub> mm	

Model	V-113-1□4
OF max.	0.34 N {35 gf}
RF min.	---
PT max.	9.0 mm
OT min.	3.2 mm
MD max.	2.8 mm
OP	15.2±2.6 mm

### Simulated Roller Lever

V-214-1□6  
V-164-1□5  
V-114-1□4

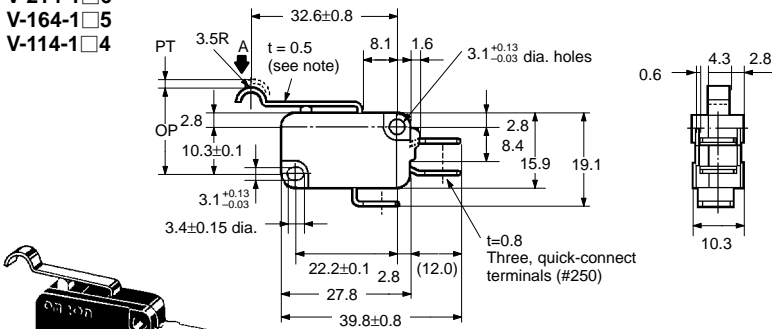

Note: Stainless-steel lever

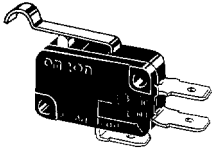

Model	V-214-1□6	V-164-1□5
OF max.	2.45 N {250 gf}	1.23 N {125 gf}
RF min.	0.25 N {25 gf}	0.14 N {14 gf}
PT max.	4.0 mm	
OT min.	1.6 mm	
MD max.	1.5 mm	
OP	18.7±1.2 mm	

Model	V-114-1□4
OF max.	0.59 N {60 gf}
RF min.	0.06 N {6 gf}
PT max.	4.0 mm
OT min.	1.6 mm
MD max.	1.5 mm
OP	18.7±1.2 mm

### Short Hinge Roller Lever

V-215-1□6  
V-165-1□5  
V-115-1□4

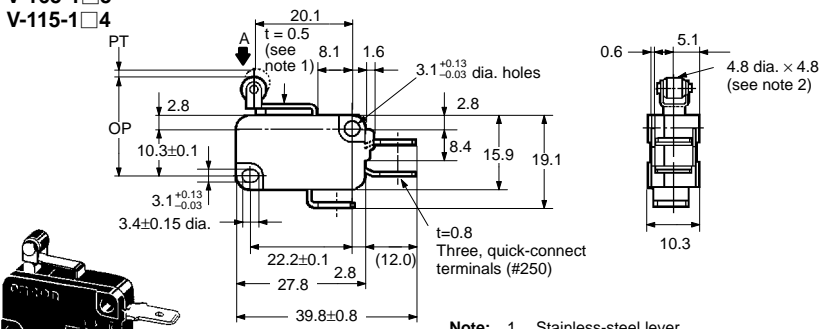

Note: 1. Stainless-steel lever  
2. Oilless polyacetal resin roller

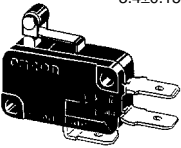

Model	V-215-1□6	V-165-1□5
OF max.	4.71 N {480 gf}	2.35 N {240 gf}
RF min.	0.49 N {50 gf}	0.49 N {50 gf}
PT max.	1.6 mm	
OT min.	0.8 mm	
MD max.	0.6 mm	
OP	20.7±0.6 mm	

Model	V-115-1□4
OF max.	1.18 N {120 gf}
RF min.	0.15 N {15 gf}
PT max.	1.6 mm
OT min.	0.8 mm
MD max.	0.6 mm
OP	20.7±0.6 mm

### Hinge Roller Lever

V-216-1□6  
V-166-1□5  
V-116-1□4

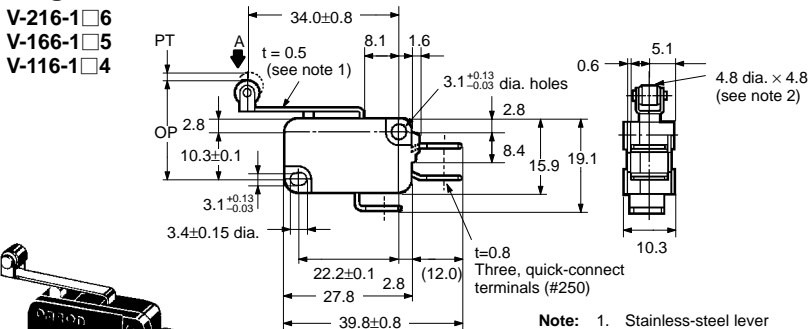

Note: 1. Stainless-steel lever  
2. Oilless polyacetal resin roller

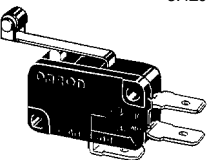

Model	V-216-1□6	V-166-1□5
OF max.	2.45 N {250 gf}	1.23 N {125 gf}
RF min.	0.25 N {25 gf}	0.14 N {14 gf}
PT max.	4.0 mm	
OT min.	1.6 mm	
MD max.	1.5 mm	
OP	20.7±1.2 mm	

Model	V-116-1□4
OF max.	0.59 N {60 gf}
RF min.	0.06 N {6 gf}
PT max.	4.0 mm
OT min.	1.6 mm
MD max.	1.5 mm
OP	20.7±1.2 mm

### ■ Thermosetting Case (V-15/-10 Models)

The following illustration and drawing are for solder and quick-connect terminals (#187) (terminals A). V models with a switching current of 15 A or 10 A incorporate terminals B or C2. These models are different from #187 models in terminal size only. Refer to *Terminals* on page 107 for these terminals.

#### Pin Plunger

V-15-1□5  
V-10-1□5  
V-10-1□4

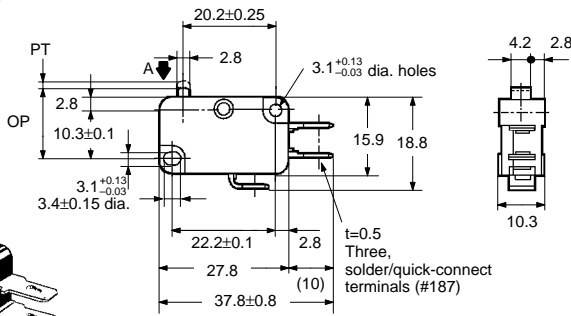
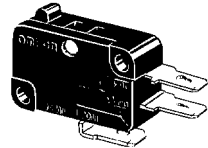

Model	V-15-1□5 V-10-1□5	V-10-1□4
OF max.	1.96 N {200 gf}	0.98 N {100 gf}
RF min.	0.49 N {50 gf}	0.20 N {20 gf}
PT max.	1.2 mm	
OT min.	1.0 mm	
MD max.	0.4 mm	
OP	14.7±0.4 mm	

#### Short Hinge Lever

V-151-1□5  
V-101-1□5  
V-101-1□4

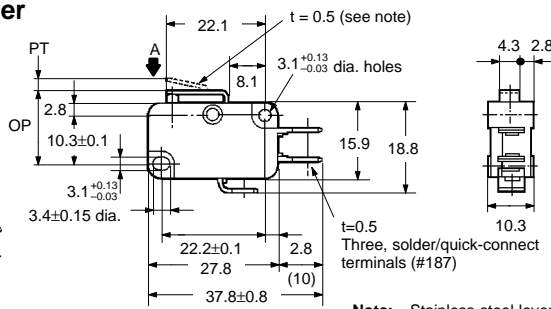
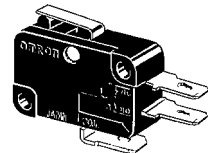

Note: Stainless-steel lever

Model	V-151-1□5 V-101-1□5	V-101-1□4
OF max.	1.96 N {200 gf}	0.98 N {100 gf}
RF min.	0.49 N {50 gf}	0.15 N {15 gf}
PT max.	1.6 mm	
OT min.	0.8 mm	
MD max.	0.6 mm	
OP	15.2±0.5 mm	

#### Hinge Lever

V-152-1□5  
V-102-1□5  
V-102-1□4

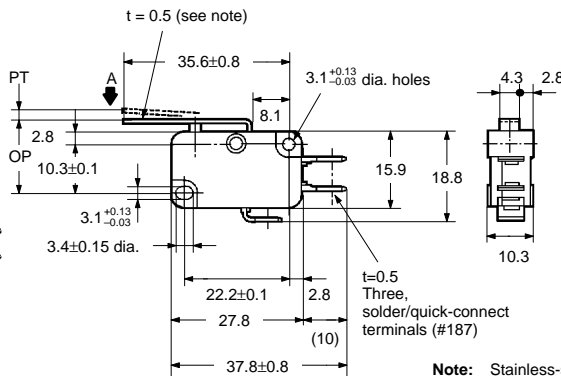
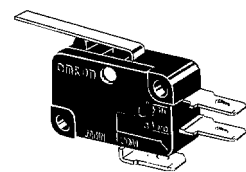

Note: Stainless-steel lever

Model	V-152-1□5 V-102-1□5	V-102-1□4
OF max.	1.23 N {125 gf}	0.59 N {60 gf}
RF min.	0.14 N {14 gf}	0.06 N {6 gf}
PT max.	4.0 mm	
OT min.	1.6 mm	
MD max.	1.5 mm	
OP	15.2±1.2 mm	

#### Long Hinge Lever

V-153-1□5  
V-103-1□5  
V-103-1□4

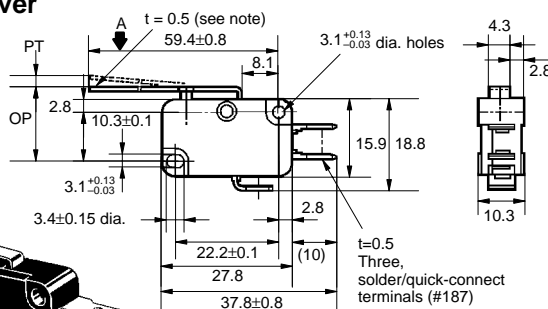
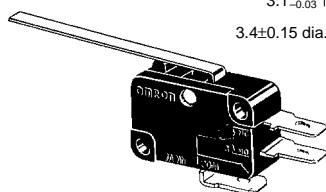

Note: Stainless-steel lever

Model	V-153-1□5 V-103-1□5	V-101-1□4
OF max.	0.69 N {70 gf}	0.34 N {35 gf}
RF min.	0.06 N {6 gf}	---
PT max.	9.0 mm	9.0 mm
OT min.	2.0 mm	3.2 mm
MD max.	2.8 mm	2.8 mm
OP	15.2 <sup>+2.6</sup> / <sub>-3.2</sub> mm	15.2±2.6 mm

### Simulated Roller Lever

V-154-1□5  
V-104-1□5  
V-104-1□4

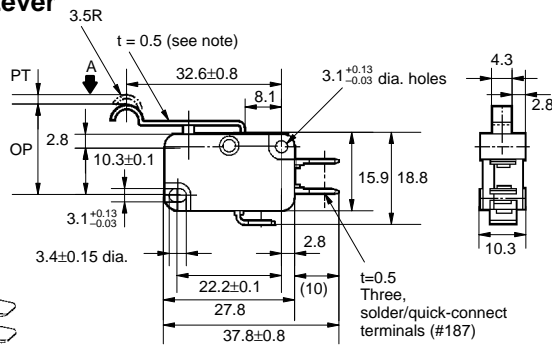
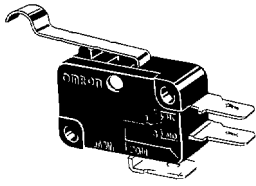

Note: Stainless-steel lever

Model	V-154-1□5 V-104-1□5	V-104-1□4
OF max.	1.23 N {125 gf}	0.59 N {60 gf}
RF min.	0.14 N {14 gf}	0.06 N {6 gf}
PT max.	4.0 mm	
OT min.	1.6 mm	
MD max.	1.5 mm	
OP	18.7±1.2 mm	

### Short Hinge Roller Lever

V-155-1□5  
V-105-1□5  
V-105-1□4

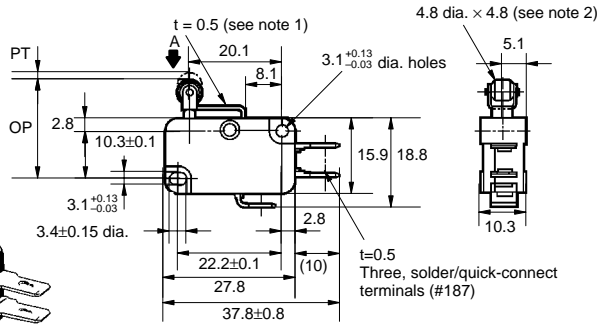
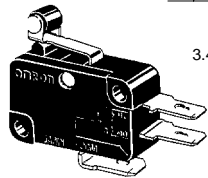

Note: 1. Stainless-steel lever  
2. Oilless polyacetal resin roller

Model	V-155-1□5 V-105-1□5	V-105-1□4
OF max.	2.35 N {240 gf}	1.18 N {120 gf}
RF min.	0.49 N {50 gf}	0.15 N {15 gf}
PT max.	1.6 mm	
OT min.	0.8 mm	
MD max.	0.6 mm	
OP	20.7±0.6 mm	

### Hinge Roller Lever

V-156-1□5  
V-106-1□5  
V-106-1□4

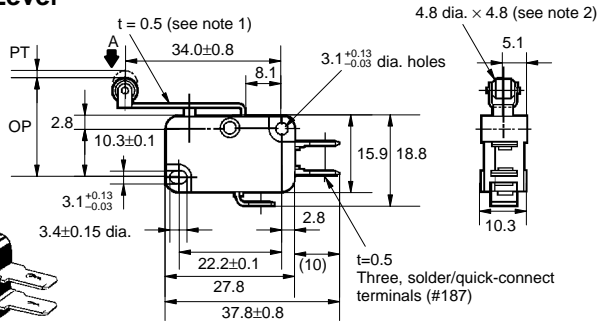
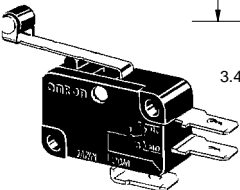

Note: 1. Stainless-steel lever  
2. Oilless polyacetal resin roller

Model	V-156-1□5 V-106-1□5	V-106-1□4
OF max.	1.23 N {125 gf}	0.59 N {60 gf}
RF min.	0.14 N {14 gf}	0.06 N {6 gf}
PT max.	4.0 mm	
OT min.	1.6 mm	
MD max.	1.5 mm	
OP	20.7±1.2 mm	

## Precautions

Refer to pages 26 to 33 for common precautions.

### ■ Correct Use

#### Specifications Approved by TÜV Rheinland According to EN61058-1

##### Appropriate Cable Size (mm<sup>2</sup>)

Model	Solder terminal	Screw terminal
V-10	0.75, 1.25, 2.0	0.75, 1.25
V-15	1.25, 2.0	1.25

Use M3 crimp terminals for connecting to the screw terminals.

Applicable M3 crimp terminals:

Daido Solderless Terminal Mfg. Co., Ltd.	F1.25-3
J.S.T. Mfg. Co., Ltd.	1.25 B3A

### Mounting

Use M3 mounting screws with plane washers or spring washers to securely mount the Switch. Tighten the screws to a torque of 0.39 to 0.59 N • m {4 to 6 kgf • cm}.

### Insulation Distance

According to EN61058-1, the minimum insulation thickness for this Switch should be 1.1 mm and minimum clearance distance between the terminal and mounting plate should be 1.9 mm. If the insulation distance cannot be provided in the product incorporating the Switch, either use a Switch with insulation barrier or use a Separator to ensure sufficient insulation distance. Refer to Separator on page 86.

### ■ Actuator (Sold Separately)

Various Actuators are available as shown on pages 139 to 142.

### ■ Connector (Sold Separately)

Refer to Terminal Connectors on page 238.



**Ph: 03 5278 8222 Fax: 03 5278 9761**  
**65 Douro Street, North Geelong VIC 3215**  
**[www.factorycontrols.com.au](http://www.factorycontrols.com.au)**

**ALL DIMENSIONS SHOWN ARE IN MILLIMETERS.**

To convert millimeters into inches, multiply by 0.03937. To convert grams into ounces, multiply by 0.03527.