



4

# Power Supplies, Surge Protection and Device Circuit Breakers

2017/2018



# Power supplies, surge protection and device circuit breakers



## Terminal blocks

- Terminal blocks



## Interface technology and switching devices

- Electronic switching devices and motor control
- Measurement and control technology
- Monitoring
- Relay modules
- System cabling for controllers



## Sensor/actuator cabling and connectors

- Sensor/actuator cabling
- Cables and lines
- Connectors



## Automation

- Lighting and signaling
- Fieldbus components and systems
- Functional safety
- HMIs and industrial PCs
- I/O systems
- Industrial cloud computing
- Industrial communication technology
- Software
- Controllers



## Marking systems, tools and mounting material

- Marking and labeling
- Tools
- Installation and mounting material



## PCB terminal blocks and PCB connectors

To quickly select a product, use our e-Paper.

**i** Web code: #1517

## Find out more with the web code

On some of the catalog pages, you can find our webcode: a hash symbol followed by a four-digit number combination.

**i** Web code: #1234 (example)

This allows you to access information on our website quickly.

### It could not be easier:

1. Go to the Phoenix Contact website
2. Enter # and the number combination in the search field
3. Get more information and product versions

Or use the direct link:

[phoenixcontact.net/webcode/#1234](http://phoenixcontact.net/webcode/#1234)

You will find the latest information and all new products directly in the product area of our website:

[phoenixcontact.net/products](http://phoenixcontact.net/products)

Also discover the Phoenix Contact catalog app interactively on your tablet.



# Table of contents

---

## Overview

The illustrated table of contents will help you find the right product more quickly

4

---

## Surge protection and interference suppression filters



7

---

## Power supplies and UPS



198

---

## Device circuit breakers



306

---

## Technical information

336

---

## Index

350

# Introduction

## Product range overview

### Surge protection for the power supply



**Type 1/2 combination protective device**  
FLASHTRAB SEC HYBRID ... Page 28  
FLASHTRAB SEC PLUS 440 ... Page 29  
FLASHTRAB SEC PLUS 350 ... Page 31  
FLASHTRAB SEC PLUS 264 ... Page 34



**Type 1/2 combination protective device**  
POWERTRAB Page 40  
VALVETRAB MST T1/T2 Page 36



**Type 1+2 protective device combination**  
FLASHTRAB SEC T1+T2... Page 42



**Type 2 surge protective device**  
VALVETRAB SEC Page 45  
VALVETRAB MS Page 52

### Set solutions



**Type 3 device protection**  
PLUGTRAB SEC / PT Page 71  
BLOCKTRAB Page 73  
MAINTRAB Page 74



Building set Page 76



FLASHTRAB ISG Page 78

### Surge protection for measurement and control technology



**DIN rail modules**  
TERMITRAB complete Page 92  
PLUGTRAB Page 96  
LINETRAB Page 100



Special systems Page 101  
LSA-PLUS modules Page 102



For networks Page 142  
For interfaces Page 144



MAINTRAB Page 74  
TERMITRAB complete Page 150  
PLUGTRAB PT-IQ Page 163

### Surge protection for transceiver systems



For mobile phone networks Page 176  
For video communication Page 177



For radio and television sets Page 180

### EMC solutions



Mains interference filters with integrated surge protection Page 184  
Interference suppression filters Page 187

### Lightning monitoring system



LM-S Page 188

**Test devices**



CHECKMASTER 2 Page 192

**Power supplies**



QUINT POWER with NFC  
QUINT POWER  
QUINT POWER,  
with protective coating Page 206  
Page 210  
Page 216



TRIO POWER Page 218



UNO POWER Page 226



MINI POWER Page 234



STEP POWER Page 238

**DC/DC converters**



QUINT DC/DC converters Page 248  
QUINT DC/DC converters,  
with protective coating Page 254  
MINI DC/DC converters Page 256

**Redundancy modules**



QUINT ORING Page 260  
QUINT S-ORING Page 262  
QUINT DIODE Page 264  
TRIO DIODE Page 266  
UNO DIODE, STEP DIODE Page 267

**UPS for the control cabinet**



QUINT DC UPS Page 274  
QUINT UPS



QUINT/TRIO AC UPS Page 280  
QUINT UPS Page 282  
TRIO UPS-2G



Energy storage for  
QUINT UPS Page 284



UPS with integrated energy storage  
QUINT UPS Page 294  
QUINT BUFFER Page 295  
STEP UPS, UNO UPS Page 298

**Device circuit breakers**



UPS with integrated power supply  
TRIO UPS Page 300  
MINI UPS Page 301



Multi-channel electronic circuit breakers –  
CBM/CBMC Page 310



Single-channel device circuit breakers  
Page 318



TCP thermal circuit breakers Page 334  
Fuse terminal blocks, see Catalog 1



# Surge protection and interference suppression filters

## Damage caused by surge voltages

The number of electrical devices damaged or destroyed by surge voltages is increasing year on year. This can prove expensive in terms of repairs and downtimes. In an industrial environment, the hazards are not only restricted to systems and devices. Building technology applications and even residential buildings may be affected.

## Interference voltages

Switching operations triggered mechanically or electronically generate pulse-like and high-frequency interference voltages. These voltages spread in an unimpeded manner across the cable network. All the devices within this cable network are affected. Data errors, uncontrolled functions, and system crashes can result, with electronic and data processing devices at particular risk.

 Your web code: [#0142](#)

<b>Basics</b>	<b>8</b>
<hr/>	
<b>Surge protection for the power supply</b>	<b>12</b>
Selection guide	16
Applications	20
Type 1/2 combination protective device	28
Type 1+2 protective device combination	42
Type 2 surge protective device	45
Type 3 device protection	71
Isolating spark gap	78
<hr/>	
<b>Surge protection for measurement and control technology</b>	<b>80</b>
Selection guide	84
Applications	86
Protection for current loops	92
Protection for digital signals	104
Protection for resistance-dependent measurements	120
Single-stage protective devices	124
Protection for EX applications	128
<hr/>	
<b>Surge protection for information technology and telecommunications</b>	<b>136</b>
Selection guides	138
Applications	140
Protection for data interfaces	142
Protection for fieldbus systems	150
Protection for telecommunications interfaces	162
<hr/>	
<b>Surge protection for transceiver systems</b>	<b>170</b>
Selection guide	172
Applications	174
Protection for antenna systems	176
Protection for TV and radio systems	180
<hr/>	
<b>Interference suppression filters</b>	<b>182</b>
<hr/>	
<b>Lightning current measurement</b>	<b>188</b>
<hr/>	
<b>Test devices</b>	<b>192</b>
<hr/>	
<b>Accessories for surge protection</b>	<b>196</b>

### Surge voltage – what is it?



#### Lightning discharge

It is above all lightning strikes (lightning electromagnetic pulse, LEMP) that have the greatest potential for damage among all the causes of occurrence.

They cause transient overvoltages that can extend across great distances and are often associated with high-amplitude surge currents.

Even the indirect effects of a lightning strike can lead to a surge voltage of several kilovolts and result in a surge current of tens of thousands of amperes. In spite of the very brief duration, such an event can lead to total failure or even the destruction of the entire system.

#### Switching operations

Switching operations (switching electromagnetic pulse, SEMP) can generate induced surge voltages that spread to supply lines. In the case of large switch-on currents or short circuits, very high currents can flow within a few milliseconds. These short-term current changes can lead to transient overvoltages.

#### Electrostatic discharge

Electrostatic discharge (ESD) occurs if exposed conductive parts with different electrostatic potential approach each other and result in a charge exchange. A sudden charge exchange leads to a brief surge voltage. This presents a hazard, especially for sensitive electronic components.

#### Surge voltage – what are the effects?

Regardless of what causes a surge voltage, the consequences are the same:

- Device destruction
- System downtimes
- Total failure of controllers

Device failure or defects caused by surge voltages are more frequent than expected. For non-private systems the consequences of a failure are generally much more serious, such as downtimes or data loss. The failure of a device or a machine that is used in a professional environment often leads to costs that are many times higher than repairing the defective device.

#### Surge voltage – how can you provide correct protection?

Effective surge protection starts with assessing the potential risk and identifying all the devices within the item to be protected. The resulting protection concept takes into account all the interfaces of the power supply unit as well as those for data and telecommunications. This is the only way to comprehensively and effectively protect all the terminal devices, for example, within a data network, production plant or building installation. Combining high-quality protective devices with innovative arrester technology, surge protective devices ensure a high degree of system availability and safety in all areas of electrical engineering.

**i** Your web code: #1133

## The protective circle principle

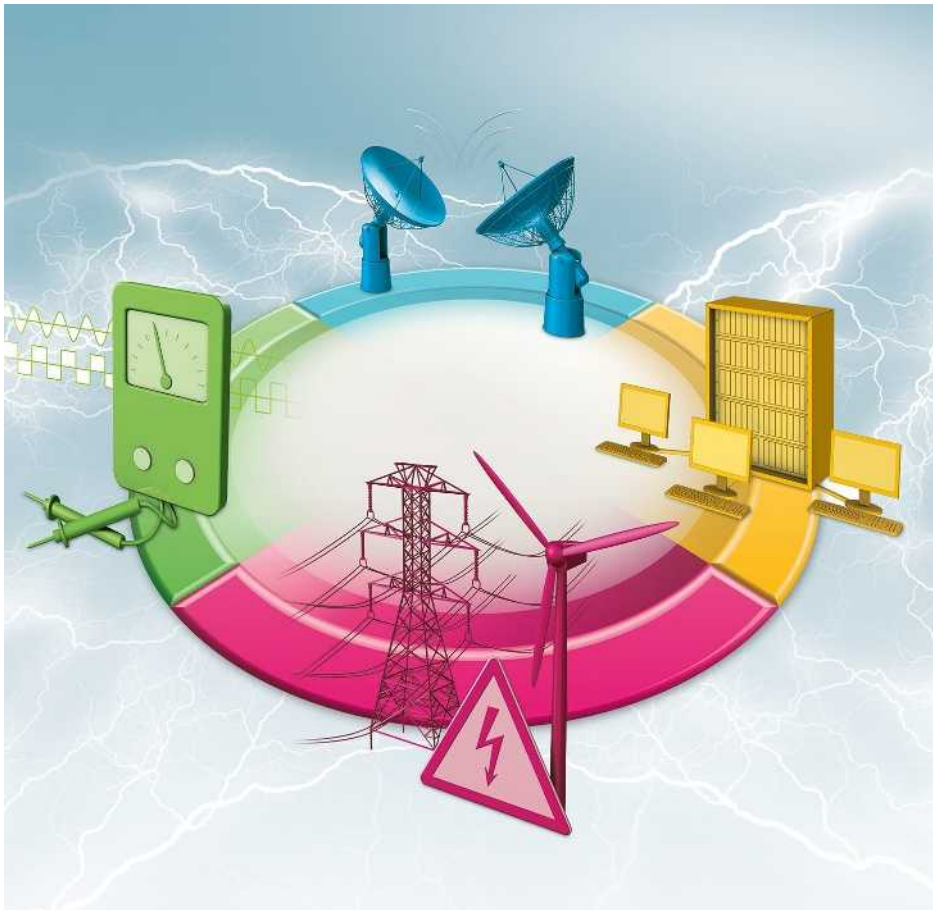

A clear illustration of the lightning protection zone concept is the protective circle.

An imaginary circle should be drawn around the object to be protected. A surge protective device should be installed at all points where cables intersect this circle.

The area within the protective circuit is therefore protected in such a way that conducted surge voltage couplings are prevented.

The protective circle must include all electrical and electronic transmission lines in the following areas:

- Power supply
- Measurement and control technology
- Information technology
- Transceiver systems



Surge protection for power supplies

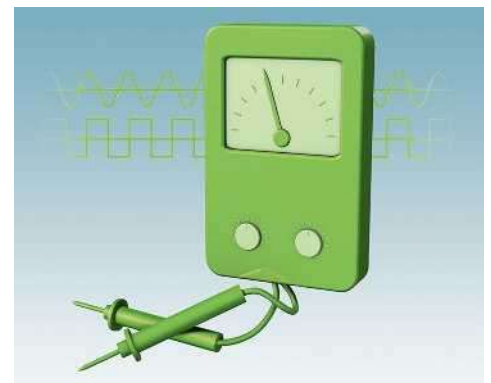

Surge protection for MCR technology



Surge protection for information technology



Surge protection for transceiver systems



### Surge protection for power supplies

#### Type 1/2 combination protective device

Type 1/2 surge protective devices must satisfy the highest requirements in terms of amplitude and specific energy from surge voltages, as they are supposed to protect against the effects of direct lightning strikes. In the typical installation environment of the main distribution, the demand placed on the short-circuit withstand capability is also often very high. In order to be able to meet these requirements, powerful technology is required, such as spark gap technology.

#### Type 2 protective device

Type 2 surge protective devices are generally installed in sub-distributions or machine control cabinets. These SPDs must be able to discharge induced surge voltages from indirect lightning strikes or switching operations but not handle direct lightning strikes. As such, the energy input is significantly reduced. In any case, induced surge voltages caused by switching operations are often very dynamic. Here, a technology with fast response behavior stands up to the test, e.g., varistor technology.

#### Type 3 device protection

Type 3 surge protective devices are generally installed immediately before the terminal device to be protected. Due to differing installation environments, type 3 SPDs are available in a very wide range of designs.

- Devices for DIN rail mounting
- Devices for insertion in sockets
- Devices for direct mounting on a PCB of the terminal device

#### Combination protective device or a combination of protective devices?

Lightning currents are simulated with surge currents in the 10/350  $\mu$ s pulse shape. Switching surge voltages and remote lightning strikes are simulated with surge currents in the 8/20  $\mu$ s pulse shape.

According to IEC 61643-11 product standard requirements, a type 2 protective device must only be able to discharge 8/20 pulses. A type 1 SPD is designed for both 8/20  $\mu$ s pulses as well as for 10/350  $\mu$ s pulses. In this way, a type 1 SPD is the same as a type 2 SPD. Exhibiting the test class II for a type 1 SPD is therefore a redundant piece of information and provides no additional qualification. Such SPDs are referred to as combination protective devices (type 1/2 SPDs). This is a protective device that satisfies both test categories.

In the case of a protective device combination such as the FLT-SEC-T1+T2, however, a voltage-switching spark gap (SPD type 1/2) is coordinated directly with a voltage-limiting varistor (SPD type 2) that is connected in parallel. Two autonomous protective devices ensure optimum response behavior, the best possible system protection, and a long component service life.



### Surge protection for MCR technology

The range of different applications presents a particular challenge to surge protection for measurement and control technology. Different signal types, interfaces, and fieldbus systems require a tailor-made product and a wide product range. Various protective circuits are therefore available that are specially optimized for the application.

Primarily, a distinction is made between two signal types: independent closed loops and signals with a common reference conductor or a shared return conductor.

The independent closed loops are often designed so that they are isolated from the ground potential for immunity to interference.



### Surge protection for information technology

In the area of information technology, the various interfaces operate with low signal levels at high frequencies. This makes them particularly sensitive to surge voltages and can lead to the destruction of electronic components in IT systems. The surge protective devices must therefore also have high-quality signal transmission behavior; as otherwise, malfunctions can be expected in the data transmission. Affected interfaces could, for example, be as follows: Ethernet, serial, and telecommunications interfaces.



### Surge protection for transceiver systems

Typical areas of application in the field of transceiver systems are the antenna connections of television and radio receivers, video communication, and mobile phone systems. Antenna cables which extend beyond a building and are usually very long, plus the antennas themselves, are directly exposed to atmospherical discharge. Surge voltages can even reach the sensitive interfaces of transceiver systems via this cable path.



### Safe Energy Control (SEC) technology

The new surge protective devices with SEC Technology represent an easy-to-install product range which combines maximum performance and superior durability. Electrical equipment is reliably protected and maintenance costs are reduced. Installation of protective devices with SEC Technology is easy, cost-effective, and space-saving.

### Isolated and durable

A consistent surge protection concept requires a powerful type 1 lightning current arrester. Conventional type 1 spark gaps burden the installation with high line follow currents, which can also cause the surge protection upstream to be triggered. The lightning current arresters in the SEC range are the first of their kind to feature spark gap technology with no line follow current. The avoidance of line follow currents benefits the entire installation. This not only applies to the protected equipment, but the entire supply, including the arrester. Maximum system availability is achieved because the fuse protection upstream is not triggered.

### Solution without backup fuse for every application

The powerful combination protective devices and surge protective devices with Safe Energy Control Technology provide a solution without separate arrester backup fuse for all common applications. For applications where the protection of the installation is the top priority, type 1 and type 2 protective devices can be used for main fuse ratings of 315 A gG without separate overcurrent protection. For applications beyond this scope, products are available with integrated surge-proof fuse, such as the FLT-SEC-HYBRID. The type 3 protective devices in the PLT-SEC family can be operated in branch wiring without any kind of backup fuse, which is also thanks to the integrated surge-proof fuses.

### Compact and consistent pluggable design

With the FLT-SEC-PLUS-440, the SEC range offers the most compact type 1 spark gap for this nominal voltage, with the VAL-SEC the narrowest type 2 arrester, and with the FLT-SEC-T1+T2 the only directly coordinated combination of type 1 spark gap and type 2 varistor arrester in a confined space. All products in the SEC range have a pluggable design. Maintenance work is therefore made much easier.

### Everything in the green – we're betting that you won't see red for five years

With the low-wear surge protective devices in the SEC range, you won't have to think about replacing wear parts for at least five years. Thanks to the SEC technology, the high-quality components are particularly durable. However, should the status indicator signal the need for replacement within the first five years following purchase, you will receive a free replacement device.

**i** Your web code: #0143



### New spark gaps

The newly developed spark gaps in the type 1 arresters are isolated and extremely powerful thanks to the use of technology with no line follow current. This increases the durability of the components in your system.



### Type 1/2 combination protective device with integrated arrester backup fuse

The FLT-SEC-HYBRID... combines surge protection and a backup fuse in a single connector. It is no longer necessary to install a separate arrester backup fuse. This saves space and reduces installation costs.



### The power package

Maximum discharge capacity in an extremely compact design. And all for continuous voltages up to 440 V. The ideal type 1/2 combination protective device for use in industry and wind turbine generators.



### Lightning current and surge protection

Reliable protection and minimal installation effort, thanks to the narrowest coordinated combination or true type 1 spark gaps and type 2 varistor arresters.



### Ultra narrow

With an overall width of just 12.5 mm per channel, the type 2 surge protective devices provide outstanding protection in a minimum amount of space - they can be used up to 315 A in the branch without a backup fuse.



### Powerful type 3 device protection

Integrated surge-proof fuses eliminate the need for a separate fuse in the branch. This saves space and simplifies planning.



### Type 1/2 combination protective devices for harsh industrial environments

With a rated voltage of 800 V AC, a discharge capacity of 35 kA per channel, and a robust housing design, POWERTRAB is ideal for harsh industrial environments and use in 690 V IT networks, such as in wind turbine generators.



### Type 1/2 combination protective devices for lightning protection class III and IV

The VAL-MS T1/T2 ... varistor-based combination protective devices meet the requirements of lightning protection class III and IV and also provide the voltage protection level of a type 2 surge protective device.



### Type 2 surge protection for higher nominal voltages

With VAL-MS..., corresponding arresters are available for power supplies with higher supply voltages, such as in wind turbine generators or when discharge currents > 30 kA per channel are required.



### Type 3 device protection in an extremely compact design

Ideal for protecting terminal devices, type 3 device protection is used in deep installation boxes, cable ducts or underfloor systems.



### Type 3 device protection as an attachment plug

The MAINTRAB device protection range is very easy to retrofit in existing installations. Versions are available as simple adapters for mains sockets or with additional signal interfaces.



### Surge protection for LED lights

The surge protective devices for LED applications are specifically designed for street, tunnel or object lighting. Different versions available for protection class I and II.



### Surge protection with residual current device

VAL-CP-RCD... are combinations of type 2 device protection with residual current device. They therefore combine personal protection and surge protection in a single device.

### Surge protection with integrated arrester backup fuse

VAL-CP-MCB... are combinations of type 2 surge protection with integrated, surge-proof circuit breakers as arrester backup fuses.

### Surge protection for 60 mm system technology

VAL-CP-MOSO... are type 2 surge protective devices with integrated, surge-proof arrester backup fuse for installation on 60 mm system technology.



### Surge protection for photovoltaic systems

The product range comprises individual components for all types of photovoltaic systems, from 600 V DC up to 1500 V DC.

### Surge protection set

The basic solution for building installations. The GEB-SET... consists of a type 1/2 combination protective device and three MAINTRAB device protection plugs.





# Surge protection and interference suppression filters





## Surge protection for the power supply

### Selection guide for 230/400 V systems

The selection matrix makes it easy to select suitable surge protection for the desired application.

Further application recommendations are available on request.

Standard applications							
Network type		IEC test classification / EN type					
		I / T1	I / T1+ $\boxtimes$	I+II / T1+T2	II / T2	III / T3	
3-phase	TN-S/TT 	230 / 400 V	✓				
				✓			
					✓		
						✓	
3-phase	TN-C 	230 / 400 V	✓				
				✓			
					✓		
						✓	
1-phase	TN-S/TT 	230 V	✓				
				✓			
					✓		
						✓	
1-phase	TN-C 	230 V	✓				
				✓			
					✓		
						✓	

Special installation requirements							
Network type		IEC test classification / EN type					
		I / T1	I / T1+ $\boxtimes$	I+II / T1+T2	II / T2	III / T3	
3-phase	TN-S/TT 	230 / 400 V	✓				
						✓	
						✓	
						✓	
3-phase	TN-C 	230 / 400 V	✓				
						✓	
						✓	
						✓	
1-phase	TN-S/TT 	230 V	✓				
						✓	
						✓	
							✓
1-phase	TN-C 	230 V	✓				



#### Note

Products bearing this stamp (plug elements) can be tested with the CHECKMASTER.

Surge protective device (SPD)		Order No.	Page
FLT-SEC-P-T1-3S-350/25-FM		2905421	31
FLT-SEC-H-T1-3C-264/25-FM	+ FLT-SEC-P-T1-N/PE-350/100-FM	2905871 + 2905472	28
FLT-SEC-T1+T2-3S-350/25-FM		2905470	42
VAL-SEC-T2-3S-350-FM		2905340	46
PLT-SEC-T3-3S-230-FM		2905230	71
FLT-SEC-P-T1-3C-350/25-FM		2905419	31
FLT-SEC-H-T1-3C-264/25-FM		2905871	28
FLT-SEC-T1+T2-3C-350/25-FM		2905469	42
VAL-SEC-T2-3C-350-FM		2905339	46
FLT-SEC-P-T1-1S-350/25-FM		2905415	33
FLT-SEC-H-T1-1C-264/25-FM	+ FLT-SEC-P-T1-N/PE-350/100-FM	2801615 + 2905472	28
FLT-SEC-T1+T2-1S-350/25-FM		2905466	43
VAL-SEC-T2-1S-350-FM		2905333	47
PLT-SEC-T3-230-FM		2905229	71
FLT-SEC-P-T1-1C-350/25-FM		2905414	33
FLT-SEC-H-T1-1C-264/25-FM		2801615	28
FLT-SEC-T1+T2-1C-350/25-FM		2905465	44









Surge protective device (SPD)		Order No.	Page
FLT-SEC-P-T1-3S-264/50-FM	Where $I_{imp} = 50$ kA in the L-N mode of protection	2909589	34
VAL-SEC-T2-3S-350/40-FM	Where $I_n = 40$ kA in the N-PE mode of protection	2909635	45
VAL-SEC-T2-3S-350VF-FM	Free of leakage current	2909590	46
VAL-CP-RCD-3S/40/0.3	Combination with RCD	2882802	67
VAL-CP-MCB-3S-350/40/FM	Combination with MCB	2882750	66
VAL-CP-MOSO 60-3S-FM	Combination with MCB for 60 mm rail system	2804403	68
GEB-SET-T1/T2 TAE/TV-SAT	Set solution for building installation	2801022	76
FLT-SEC-P-T1-3C-264/50-FM	Where $I_{imp} = 50$ kA in the L-N mode of protection	2907390	34
VAL-SEC-T2-3C-350VF-FM	Free of leakage current	2909591	46
VAL-CP-MCB-3C-350/40/FM	Combination with MCB	2882776	66
VAL-CP-MOSO 60-3C-FM	Combination with MCB for 60 mm rail system	2804416	68
FLT-SEC-P-T1-1S-264/50-FM	Where $I_{imp} = 50$ kA in the L-N mode of protection	2907388	35
VAL-SEC-T2-1S-350VF-FM	Free of leakage current	2909592	47
VAL-CP-MCB-1S-350/40/FM	Combination with MCB	2882763	66
MNT-1 D	Attachment plug	2882200	74
BT-1S-230AC/A	Universal mounting (acoustic)	2803409	73
BT-1S-230AC/O	Universal mounting (optical)	2800625	73
FLT-SEC-P-T1-1C-264/50-FM	Where $I_{imp} = 50$ kA in the L-N mode of protection	2907387	35

# Surge protection and interference suppression filters

## Surge protection for the power supply

### Selection guide for other network types

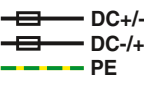
The selection matrix makes it easy to select suitable surge protection for the desired application. Further application recommendations on request.

Network type				IEC test classification/EN type				
				I / T1	I / T1+ ⚡	I+II/T1+T2	II / T2	III / T3
3-phase	TN-S/TT		120 / 208 V				✓	
			400 / 690 V	✓				
	TN-C		120 / 208 V	✓			✓	
			400 / 690 V	✓	✓		✓	
			554 / 960 V	✓			✓	
	IT		400 V	✓	✓		✓	
500 - 690 V			✓			✓		
2-phase	TN-S/TT		120 / 208 V				✓	
	TN-C		120 / 208 V				✓	
1-phase	TN-S/TT		120 V	✓			✓	✓
	TN-C		120 V				✓	
Linear DC source		24 / 48 V	✓			✓		
		24 V					✓	
		48 V					✓	
		120 V				✓	✓	
		220 V				✓		
		380 V	✓					
Photovoltaics DC source	1 string		600 V	✓			✓	
			1000 V	✓			✓	
			1500 V	✓			✓	



#### Note

Products bearing this stamp (plug elements) can be tested with the CHECKMASTER.

Surge protective device (SPD)	Order No.	Page
VAL-SEC-T2-3S-175-FM	2905354	48
FLT-SEC-P-T1-3S-440/35-FM	2908264	29
VAL-MS-T1/T2 175/12.5/3+0-FM	2800672	37
VAL-SEC-T2-3C-175-FM	2905353	48
FLT-SEC-P-T1-3C-440/35-FM	2905988	29
FLT-SEC-H-T1-3C-440/25-FM	2907260	28
VAL-SEC-T2-3C-440-FM	2909968	45
PWT 100-800AC-FM	2800531	40
VAL-MS 750/30/3+0-FM	2920272	56
FLT-SEC-P-T1-3C-440/35-FM	2905988	29
FLT-SEC-H-T1-3C-440/25-FM	2907260	28
VAL-SEC-T2-3C-440-FM	2909968	45
PWT 100-800AC-FM	2800531	40
VAL-MS 750/30/3+0-FM	2920272	56
VAL-SEC-T2-2S-175-FM	2905351	49
VAL-SEC-T2-2C-175-FM	2905350	49
VAL-MS-T1/T2 175/12.5/1+1-FM	2800674	37
VAL-SEC-T2-1S-175-FM	2905348	49
PLT-SEC-T3-120-FM	2905228	71
VAL-MS 120 ST + VAL-MS BE/FM	2807586 + 2817738	58
VAL-MS-T1/T2 48/12.5/1+1V-FM	2801533	38
VAL-SEC-T2-2+0-48DC-FM	2907865	50
PLT-SEC-T3-24-FM	2905223	71
PLT-SEC-T3-60-FM	2905225	71
VAL-SEC-T2-2+0-120DC-FM	2907874	50
PLT-SEC-T3-120-FM	2905228	71
VAL-SEC-T2-2+0-220DC-FM	2907875	51
PLT-SEC-T3-230-FM	2905229	71
VAL-SEC-T2-2+0-380DC-FM	2907876	51
VAL-MS-T1/T2 600DC-PV/2+V-FM	2801164	41
VAL-MS 600DC-PV/2+V-FM	2800641	65
VAL-MS-T1/T2 1000DC-PV/2+V-FM	2801161	41
VAL-MS 1000DC-PV/2+V-FM	2800627	65
VAL-MB-T1/T2 1500DC-PV/2+V-FM	2905640	41
VAL-MB-T2 1500DC-PV/2+V-FM	2905646	64

# Surge protection and interference suppression filters

## Surge protection for the power supply

### Type 1 protection for the power supply with integrated arrester backup fuse

#### FLT-SEC-HYBRID

Branch wiring in the TN-C network

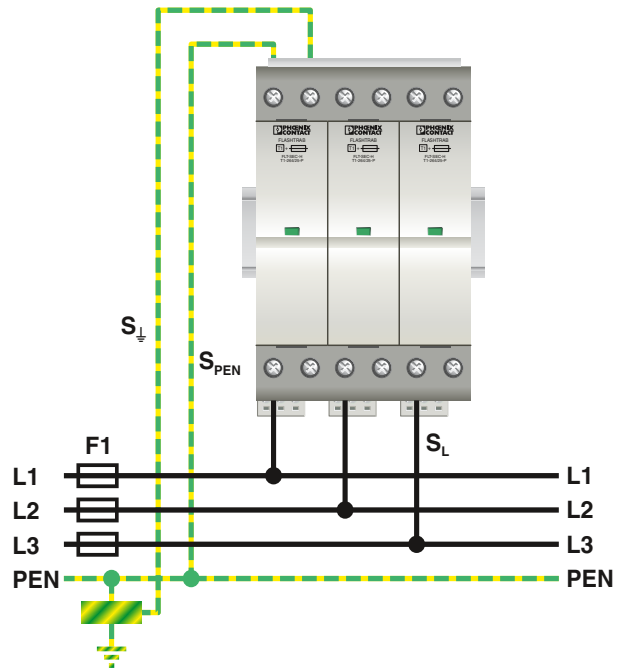

Technical characteristics	
Typical installation location	Upstream or downstream of the circuit breaker of low-voltage distribution boards with large load currents
Lightning protection class	I, II, III, IV
Lightning protection zone transition	LPZ 0 <sub>A</sub> → LPZ 1
Coordination	Coordination with type 2 arresters of the SEC family is guaranteed
Connecting cables	<ul style="list-style-type: none"> <li>The required conductor cross sections must be taken from the table.</li> <li>The connection to the main grounding rail (<math>S_{\text{earth}}</math>) is absolutely essential (see figure).</li> <li>For <math>S_{\text{L}}</math>, use a minimum cross section of 16 mm<sup>2</sup>. If this connection (<math>S_{\text{L}}</math>) is to be equal to the connection to the protective conductor (<math>S_{\text{PEN}}</math>) in the application, use a minimum cross section of 35 mm<sup>2</sup> for <math>S_{\text{PEN}}</math>.</li> <li>If the cable cross section is greater than 35 mm<sup>2</sup>, make sure that the surge protection connecting cables (<math>S_{\text{L}}</math>) are protected against ground faults and short circuits. Recommendation: use temperature-stable cables for <math>S_{\text{L}}</math>, e.g., XLPE/EPR-insulated cables.</li> <li>Lay the connecting cables as short as possible, without loops, and with the largest possible bending radii.</li> </ul>
Backup fuses	<ul style="list-style-type: none"> <li>Can be used without backup fuse in branch wiring</li> <li>The integrated overcurrent protection is selective to upstream F1 fuses ≥ 400 A gG</li> </ul>
Products in the catalog	Page 28

$S_{\text{L}}$ mm <sup>2</sup>	$S_{\text{PEN}}$ mm <sup>2</sup>
35	35

Table 1: Connecting cables

	$U_{\text{max}}$	$I_{\text{max}}$
AC	250 V	1 A
AC	125 V (UL)	1 A (UL)
DC	125 V	0.2 A
DC	30 V	1 A
0.14 mm <sup>2</sup> ... 1.5 mm <sup>2</sup>		

Table 2: Remote signaling data

### Type 1 protection for the power supply

#### FLT-SEC-PLUS

Branch wiring in the TN-C network

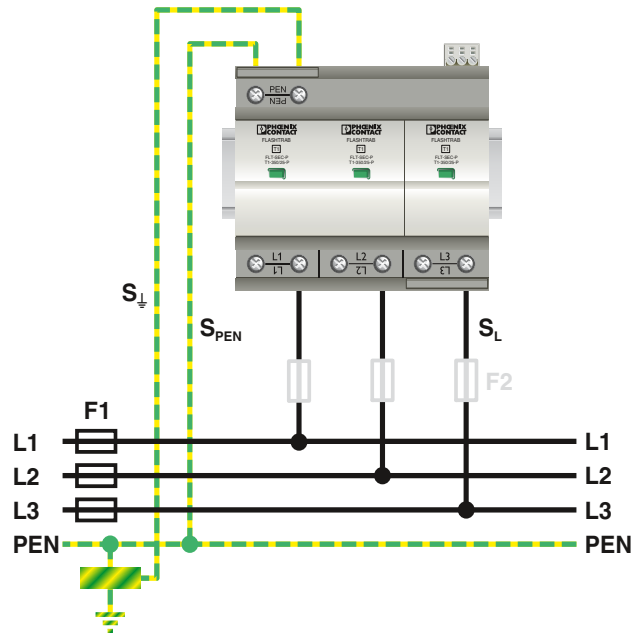

Technical characteristics	
Typical installation location	Where the cable enters the building or in the pre-meter or post-meter area
Lightning protection class	I, II, III, IV
Lightning protection zone transition	LPZ 0 <sub>A</sub> → LPZ 1
Coordination	Coordination with type 2 arresters of the SEC family is guaranteed
Connecting cables	<ul style="list-style-type: none"> <li>The required conductor cross sections must be taken from the tables.</li> <li>The connection to the main grounding rail (<math>S_{\downarrow}</math>) is absolutely essential (see figure).</li> <li>For <math>S_{\downarrow}</math>, use a minimum cross section of 16 mm<sup>2</sup>. If this connection (<math>S_{\downarrow}</math>) is to be equal to the connection to the protective conductor (<math>S_{PEN}</math>) in the application, use a minimum cross section of 16 mm<sup>2</sup> for <math>S_{PEN}</math>.</li> <li>Lay the connecting cables as short as possible, without loops, and with the largest possible bending radii.</li> </ul>
Backup fuses	<ul style="list-style-type: none"> <li>Can be used without backup fuse in branch wiring up to 315 A gG</li> <li>If the surge protection fuse needs to be selective to the upstream installation, a separate F2 backup fuse is required. Once F2 has tripped, there is no more surge protection for the system.</li> <li>Can be used without backup fuse in through wiring up to 125 A gG</li> </ul>
Products in the catalog	Page 29

F1 A gG	F2 A gG	S <sub>L</sub> mm <sup>2</sup>	S <sub>PEN</sub> (S <sub>PEN</sub> = S <sub>↓</sub> ) mm <sup>2</sup>
40		6	6 (16)
50		10	10 (16)
63		10	10 (16)
80		10	10 (25)
100		16	16 (25)
125		16	16 (25)
160		25	25
200		25	25 (35)
250		35	35
315		2 x 25	2 x 25
400	≤ 250	35	35
≥ 500	≤ 315	2 x 25	2 x 25

Table 1: Branch wiring

F1 A gG	S <sub>L</sub> mm <sup>2</sup>	S <sub>PEN</sub> (S <sub>PEN</sub> = S <sub>↓</sub> ) mm <sup>2</sup>
40	10	10 (16)
50	10	10 (16)
63	10	10 (25)
80	16	16 (25)
100	25	25
125	35	35

Table 2: Through wiring

	U <sub>max</sub>	I <sub>max</sub>
AC	250 V	1 A
AC	125 V (UL)	1 A (UL)
DC	125 V	0.2 A
DC	30 V	1 A
0.14 mm <sup>2</sup> ... 1.5 mm <sup>2</sup>		

Table 3: Remote signaling data

# Surge protection and interference suppression filters

## Surge protection for the power supply

### Type 1+2 protection for the power supply

#### FLT-SEC-T1+T2

##### Branch wiring in the TN-S network

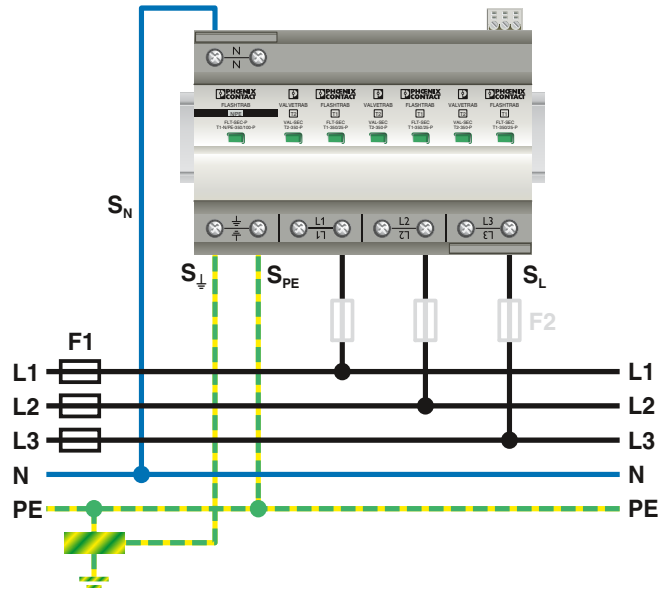

Technical characteristics	
Typical installation location	Where the cable enters the building in the post-meter area
Lightning protection class	I, II, III, IV
Lightning protection zone transition	LPZ 0 <sub>A</sub> → LPZ 2
Coordination	Coordination with type 3 arresters of the SEC family is guaranteed
Connecting cables	<ul style="list-style-type: none"> <li>The required conductor cross sections must be taken from the tables.</li> <li>The connection to the main grounding rail (<math>S_N</math>) is absolutely essential (see figure).</li> <li>For <math>S_N</math>, use a minimum cross section of 16 mm<sup>2</sup>. If this connection (<math>S_N</math>) is to be equal to the connection to the protective conductor (<math>S_{PE}</math>) in the application, use a minimum cross section of 16 mm<sup>2</sup> for <math>S_{PE}</math>.</li> <li>Lay the connecting cables as short as possible, without loops, and with the largest possible bending radii.</li> </ul>
Backup fuses	<ul style="list-style-type: none"> <li>Can be used without backup fuse in branch wiring up to 315 A gG</li> <li>If the surge protection fuse needs to be selective to the upstream installation, a separate F2 backup fuse is required. Once F2 has tripped, there is no more surge protection for the system.</li> <li>Can be used without backup fuse in through wiring up to 125 A gG</li> </ul>
Products in the catalog	Page 42

F1 A gG	F2 A gG	$S_L = S_N$ mm <sup>2</sup>	$S_{PE} (S_{PE} = S_L)$ mm <sup>2</sup>
40		6	6 (16)
50		10	10 (16)
63		10	10 (16)
80		10	10 (25)
100		16	16 (25)
125		16	16 (25)
160		25	25
200		25	25(35)
250		35	35
315		2 x 25	2 x 25
400	≤ 250	35	35
≥ 500	≤ 315	2 x 25	2 x 25

Table 1: Branch wiring

F1 A gG	$S_L = S_N$ mm <sup>2</sup>	$S_{PE} (S_{PE} = S_L)$ mm <sup>2</sup>
40	10	10 (16)
50	10	10 (16)
63	10	10 (25)
80	16	16 (25)
100	25	25
125	35	35

Table 2: Through wiring

	$U_{max}$	$I_{max}$
AC	250 V	1 A
AC	125 V (UL)	1 A (UL)
DC	125 V	0.2 A
DC	30 V	1 A
0.14 mm <sup>2</sup> ... 1.5 mm <sup>2</sup>		

Table 3: Remote signaling data

### Type 2 protection for the power supply

#### VAL-SEC

##### Branch wiring in the TN-S network

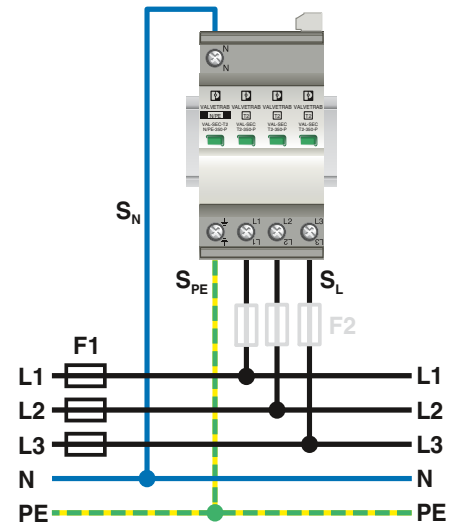

Technical characteristics	
<b>Typical installation location</b>	In sub-distributions or level distributions upstream of the RCD
<b>Lightning protection zone transition</b>	LPZ 0 <sub>B</sub> → LPZ 1 LPZ 1 → LPZ 2
<b>Coordination</b>	Coordination with type 1 and type 3 arresters of the SEC family is guaranteed
<b>Connecting cables</b>	<ul style="list-style-type: none"> <li>– The required conductor cross sections must be taken from the tables.</li> <li>– For backup fuses &gt; 200 A in relation to PVC-insulated copper cables, it is not possible to clamp a sufficient cross section for short circuits and ground faults. Special measures must therefore be implemented in this area to ensure that the connecting cables are protected against short circuits and ground faults. Prevent the cables from touching each other or touching conductive components, e.g., by using spacers, or use cables with increased temperature stability (e.g., XLPE/EPR-insulated cables).</li> <li>– Lay the connecting cables as short as possible, without loops, and with the largest possible bending radii.</li> </ul>
<b>Backup fuses</b>	<ul style="list-style-type: none"> <li>– Can be used without backup fuse in branch wiring up to 315 A gG</li> <li>– If the surge protection fuse needs to be selective to the upstream installation, a separate F2 backup fuse is required. Once F2 has tripped, there is no more surge protection for the system.</li> <li>– Can be used without backup fuse in through wiring up to 63 A gG</li> </ul>
<b>Products in the catalog</b>	Page 46

F1 A gG	F2 A gG	S <sub>L</sub> = S <sub>N</sub> mm <sup>2</sup>	S <sub>PE</sub> mm <sup>2</sup>
25		6	6
32		6	6
40		6	6
50		6	6
63		6	6
80		10	10
100		10	10
125		16	16
160		16	16
200		25	25
250		25	25
315		25	25
400	≤ 250	25	25
≥ 500	≤ 315	25	25

Table 1: Branch wiring

F1 A gG	S <sub>L</sub> = S <sub>N</sub> mm <sup>2</sup>	S <sub>PE</sub> mm <sup>2</sup>
25	6	6
32	6	6
40	6	6
50	10	10
63	10	10

Table 2: Through wiring

	U <sub>max</sub>	I <sub>max</sub>
AC	250 V	1 A
AC	125 V (UL)	1 A (UL)
DC	125 V	0.2 A
DC	30 V	1 A
0.14 mm <sup>2</sup> ... 1.5 mm <sup>2</sup>		

Table 3: Remote signaling data

# Surge protection and interference suppression filters

## Surge protection for the power supply

### Type 2 protection for the power supply

#### VAL-SEC DC

Branch wiring in insulated  
DC voltage systems

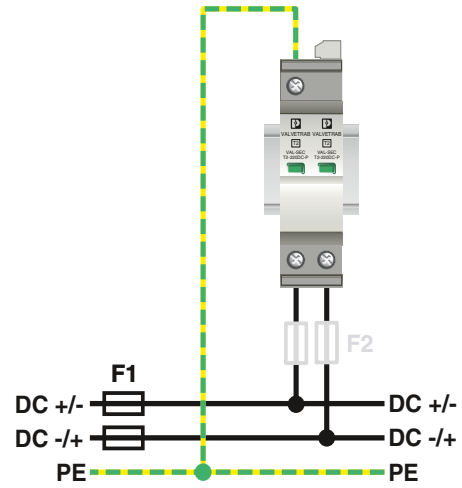

Technical characteristics	
Typical installation location	Main and sub-distribution
Lightning protection zone transition	LPZ 0 <sub>B</sub> → LPZ 1 LPZ 1 → LPZ 2
Coordination	Coordination with type 3 SPDs of the SEC family is guaranteed.
Connecting cables	<ul style="list-style-type: none"> <li>For branch wiring, the connecting cables and cross sections only have to be designed for short circuits and ground faults.</li> <li>For through wiring, operating current and overload also have to be taken into account.</li> <li>Lay the connecting cables as short as possible, without loops, and with the largest possible bending radii</li> </ul>
Backup fuses	The required backup fuses must be taken from the tables.
Products in the catalog	Page 51

Prospective short-circuit current $I_p$ at installation location	Backup fuse (F2)
$\leq 200$ A	-
$> 200$ A	20 A (gG / MCB characteristic B)

#### Backup fuses for $U_N \leq 220$ V DC

Prospective short-circuit current $I_p$ at installation location	Backup fuse (F2)
$\leq 100$ A	-
$> 100$ A	10 A (gG / MCB characteristic B)
$> 200$ A	20 A (gG / MCB characteristic B)

#### Backup fuses for $U_N \leq 400$ V DC

	$U_{max}$	$I_{max}$
AC	250 V	1 A
AC	125 V (UL)	1 A (UL)
DC	125 V	0.2 A
DC	30 V	1 A
0.14 mm <sup>2</sup> ... 1.5 mm <sup>2</sup>		

Table 3: Remote signaling data

### Type 3 protection for the power supply

#### PLT-SEC

Through wiring and branch wiring in the TN-S network

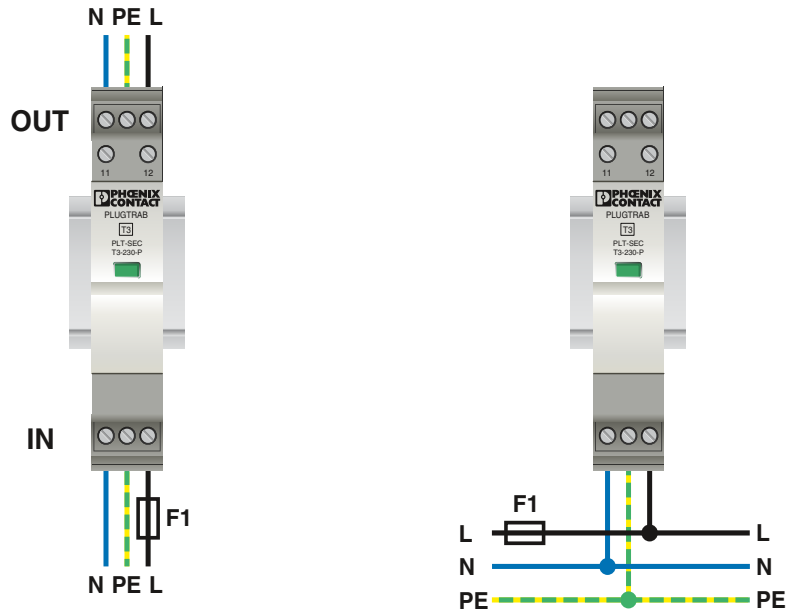

Technical characteristics	
Typical installation location	Upstream of the terminal device to be protected
Lightning protection zone transition	LPZ 2 → LPZ 3
Coordination	Coordination with type 2 arresters of the SEC family is guaranteed
Connection	<ul style="list-style-type: none"> <li>– Max. conductor cross section 4 mm<sup>2</sup> solid and 2.5 mm<sup>2</sup> stranded</li> <li>– The maximum load current <math>I_L</math> is 26 A for through wiring</li> </ul>
Backup fuses	<ul style="list-style-type: none"> <li>– Can be used without backup fuse for prospective short-circuit currents up to 1500 A</li> <li>– The integrated overcurrent protection is selective to upstream F1 fuses <math>\geq 16</math> A gG</li> <li>– For backup fuses &gt; 40 A, make sure that the connecting cables are protected against ground faults and short circuits.</li> </ul> <p><b>Recommendation:</b> use cables with increased temperature stability, such as XLPE/EPR-insulated cables.</p>
Products in the catalog	Page 71

	$U_{max}$	$I_{max}$
AC	250 V	3 A
DC	125 V	0.2 A
DC	30 V	1 A
0.2 mm <sup>2</sup> ... 2.5 mm <sup>2</sup>		

Table 1: Remote signaling data

# Surge protection and interference suppression filters

## Surge protection for the power supply

### Type 2 protection for the power supply

#### VAL-CP-RCD

##### Branch wiring in the TN-S network

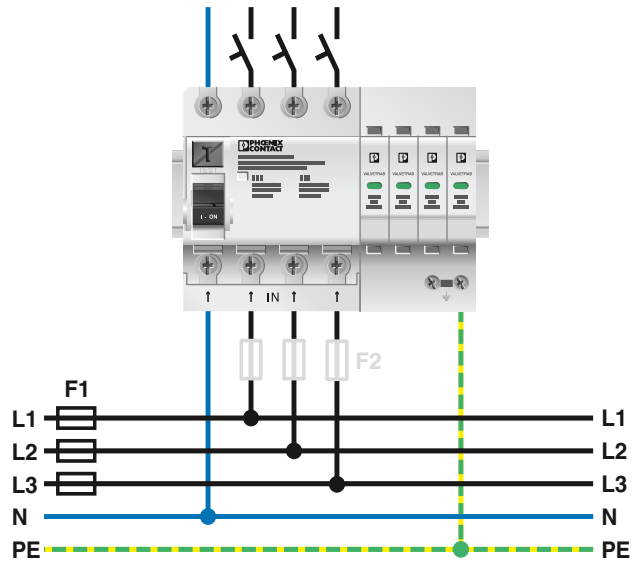

#### Technical characteristics

<b>Typical installation location</b>	In sub-distributions in place of an RCD
<b>Lightning protection zone transition</b>	LPZ 0 <sub>B</sub> → LPZ 1 LPZ 1 → LPZ 2
<b>Coordination</b>	Coordination with type 1 and type 3 arresters of the SEC family is guaranteed
<b>RCD</b>	The RCD used is a type A/type A selective
<b>Connection</b>	<ul style="list-style-type: none"><li>- The conductor cross sections are based on the upstream F1 overcurrent protection device</li><li>- F1 ≤ 50 A → 6 mm<sup>2</sup></li><li>- F1 &gt; 50 A → 10 mm<sup>2</sup></li><li>- Lay the connecting cables as short as possible, without loops, and with the largest possible bending radii</li><li>- The maximum load current I<sub>L</sub> is 40 A</li></ul>
<b>Backup fuses</b>	- Can be used without backup fuse in branch and through wiring up to 63 A gG
<b>Products in the catalog</b>	Page 67

### Type 2 protection for the power supply

#### VAL-CP-MCB

Branch wiring in the TN-S network

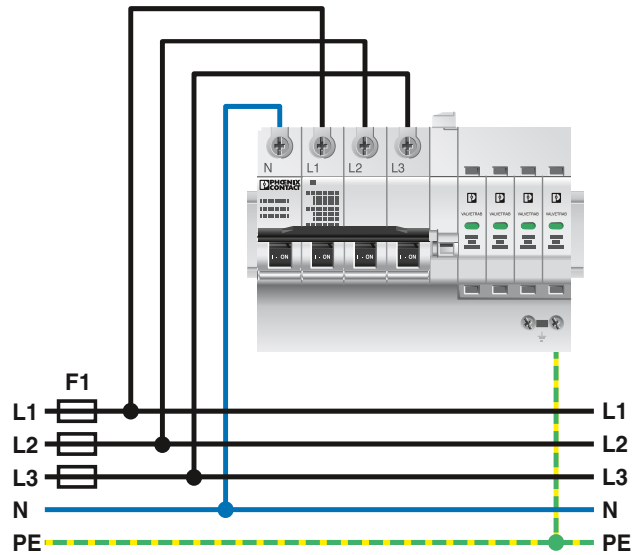

Technical characteristics	
<b>Typical installation location</b>	In sub-distributions or level distributions upstream of the RCD
<b>Lightning protection zone transition</b>	LPZ 0 <sub>B</sub> → LPZ 1 LPZ 1 → LPZ 2
<b>Coordination</b>	Coordination with type 1 and type 3 arresters of the SEC family is guaranteed
<b>Connecting cables</b>	<ul style="list-style-type: none"> <li>– The required conductor cross sections must be taken from the table</li> <li>– For backup fuses &gt; 250 A in relation to PVC-insulated copper cables, it is not possible to clamp a sufficient cross section for short circuits and ground faults. Special measures must therefore be implemented in this area to ensure that the connecting cables are protected against short circuits and ground faults. Prevent the cables from touching each other or touching conductive components, e.g., by using spacers, or use cables with increased temperature stability (e.g., XLPE/EPR-insulated cables).</li> <li>– Lay the connecting cables as short as possible, without loops, and with the largest possible bending radii</li> </ul>
<b>Backup fuses</b>	<ul style="list-style-type: none"> <li>– Can be used without backup fuse in branch wiring</li> <li>– The integrated overcurrent protection is selective to upstream F1 fuses ≥ 63 A gG</li> </ul>
<b>Products in the catalog</b>	Page 66

F1 A gG	S <sub>L</sub> = S <sub>N</sub> mm <sup>2</sup>	S <sub>PE</sub> mm <sup>2</sup>
63	10	10
80	10	10
100	16	16
125	16	16
160	25	25
200	25	25
250	35	2 x 16
> 250	35	2 x 16

Table 1: Branch wiring

	U <sub>max</sub>	I <sub>max</sub>
AC	250 V	2 A
DC	250 V	0.05 A
0.14 mm <sup>2</sup> ... 1.5 mm <sup>2</sup>		

Table 2: Remote signaling data

# Surge protection and interference suppression filters

## Surge protection for the power supply

### Type 1/2 combination protective device FLASHTRAB SEC HYBRID

- Integrated combination of spark gap without line follow current and surge-proof fuse
- Can be used without separate backup fuse thanks to integrated overcurrent protection
- Free of leakage current, suitable for use in the pre-meter area
- 440 V versions satisfy TOV requirements for use in IT systems
- Can be inserted with innovative push-pull locking mechanism
- Low voltage protection level of 1.5 kV for 264 V and 2.5 kV for 440 V versions
- Optical, mechanical status indicator
- With floating remote indication contact
- Plugs can be checked with CHECKMASTER

**Notes:**  
If only one value is specified under mode of protection in the technical data, this value is valid for all modes of protection specified.



4-conductor system;  
L1, L2, L3, PEN

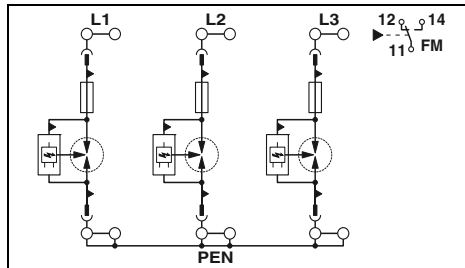

new



2-conductor system;  
L, PEN

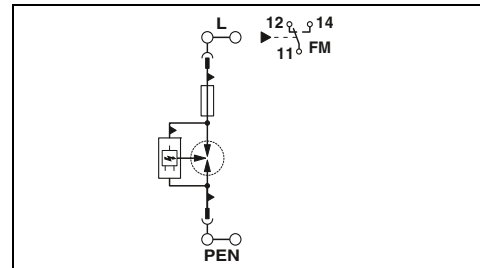

new

Electrical data	
IEC test classification	... 264
Nominal voltage $U_N$	240/415 V AC (TN-C)
Mode of protection	
Maximum continuous operating voltage $U_C$	L-PEN
Impulse discharge current $I_{imp}$ (10/350) $\mu$ s	264 V AC
Nominal discharge current $I_n$ (8/20) $\mu$ s	25 kA
Max. discharge current $I_{max}$ (8/20) $\mu$ s	25 kA
Protection level $U_p$	50 kA
Follow current interrupt rating $I_{fi}$	$\leq 1.5$ kV
Response time $t_A$	50 kA
Short-circuit current rating $I_{SCCR}$	$\leq 100$ ns
General data	
Dimensions W/H/D	106.8 mm / 167 mm / 74.5 mm
IEC connection data	2.5 ... 35 mm <sup>2</sup> / 2.5 ... 35 mm <sup>2</sup> / 13 ... 2
Temperature range	-40 °C ... 80 °C
Test standards	IEC 61643-11 / EN 61643-11
Remote indication contact	PDT contact
IEC connection data	0.14 ... 1.5 mm <sup>2</sup> / 0.14 ... 1.5 mm <sup>2</sup> / 28 ... 16
Max. operating voltage	250 V AC / 125 V DC (200 mA DC)
Max. operating current	1 A AC / 1 A DC (30 V DC)

Technical data	
... 264	... 440
I / II, T1 / T2	I / II, T1 / T2
240/415 V AC (TN-C)	400/690 V AC (TN-C) / 400 V AC (IT)
L-PEN	
264 V AC	440 V AC
25 kA	25 kA
25 kA	25 kA
50 kA	50 kA
$\leq 1.5$ kV	$\leq 2.5$ kV
50 kA	50 kA
$\leq 100$ ns	$\leq 100$ ns
50 kA	50 kA

Technical data	
... 264	... 440
I / II, T1 / T2	I / II, T1 / T2
240 V AC (TN-C)	400 V AC (TN) / 400 V AC (IT)
L-PEN	
264 V AC	440 V AC
25 kA	25 kA
25 kA	25 kA
50 kA	50 kA
$\leq 1.5$ kV	$\leq 2.5$ kV
50 kA	50 kA
$\leq 100$ ns	$\leq 100$ ns
50 kA	50 kA

Description		$U_C$
FLASHTRAB		264 V AC
		440 V AC
Replacement plug		L-N / L-PEN
		L-N / L-PEN
Wiring bridge, 35 mm <sup>2</sup>		
6-pos.		
8-pos.		

Ordering data			
Type	Order No.	Pcs./Pkt.	
FLT-SEC-H-T1-3C-264/25-FM	2905871	1	
FLT-SEC-H-T1-3C-440/25-FM	2907260	1	
Accessories			
FLT-SEC-H-T1-264/25-P	2905968	1	
FLT-SEC-H-T1-440/25-P	2907261	1	
MPB 18/1-6/35	2908705	10	
MPB 18/1-8/35	2908704	10	

Ordering data			
Type	Order No.	Pcs./Pkt.	
FLT-SEC-H-T1-1C-264/25-FM	2801615	1	
FLT-SEC-H-T1-1C-440/25-FM	2907259	1	
Accessories			
FLT-SEC-H-T1-264/25-P	2905968	1	
FLT-SEC-H-T1-440/25-P	2907261	1	
MPB 18/1-6/35	2908705	10	
MPB 18/1-8/35	2908704	10	

### Type 1/2 combination protective device FLASHTRAB SEC PLUS 440

- Spark gap has no line follow current
- Free of leakage current, suitable for use in the pre-meter area
- Satisfies TOV requirements for use in IT systems
- Pluggable
- Low voltage protection level of 2.5 kV
- Optical, mechanical status indicator
- With floating remote indication contact
- Plugs can be checked with CHECKMASTER



5-conductor system;  
L1, L2, L3, N, PE



4-conductor system,  
L1, L2, L3, PE(N)

#### Notes:

If only one value is specified under mode of protection in the technical data, this value is valid for all modes of protection specified.

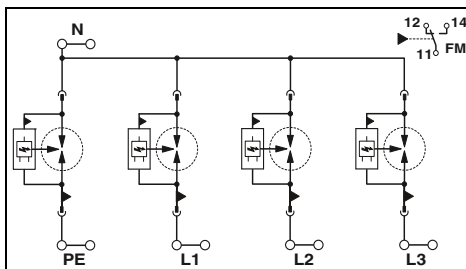

ERIC KEBA CB

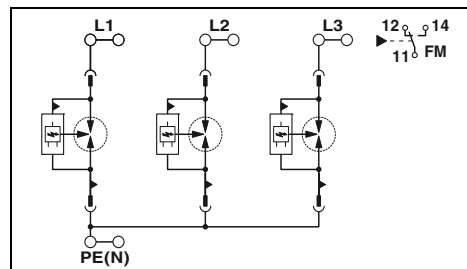

#### Technical data

Electrical data	
IEC test classification	I / II, T1 / T2
Nominal voltage $U_N$	400/690 V AC (TN-S) / 400/690 V AC (TT)
Mode of protection	
Maximum continuous operating voltage $U_C$	L-N / L-PE / N-PE 440 V AC
Impulse discharge current $I_{imp}$ (10/350) $\mu$ s	35 kA / 35 kA / 100 kA
Nominal discharge current $I_n$ (8/20) $\mu$ s	35 kA / 35 kA / 100 kA
Max. discharge current $I_{max}$ (8/20) $\mu$ s	50 kA / 50 kA / -
Protection level $U_p$	$\leq 2.5$ kV / $\leq 4.5$ kV / $\leq 2.5$ kV
Follow current interrupt rating $I_{fi}$	50 kA / 50 kA / 100 A
Response time $t_A$	$\leq 100$ ns
Short-circuit current rating $I_{SCCR}$	50 kA
Max. backup fuse with branch wiring	400 A (gG)
General data	
Dimensions W/H/D	142.4 mm / 95.2 mm / 74.5 mm
IEC connection data	2.5 ... 35 mm <sup>2</sup> / 2.5 ... 35 mm <sup>2</sup> / 13 ... 2
Temperature range	-40 °C ... 80 °C
Test standards	IEC 61643-11 / EN 61643-11
Remote indication contact	PDT contact
IEC connection data	0.14 ... 1.5 mm <sup>2</sup> / 0.14 ... 1.5 mm <sup>2</sup> / 28 ... 16
Max. operating voltage	250 V AC / 125 V DC (200 mA DC)
Max. operating current	1 A AC / 1 A DC (30 V DC)

#### Ordering data

Description	Type	Order No.	Pcs./Pkt.
FLASHTRAB	FLT-SEC-P-T1-3S-440/35-FM	2908264	1

#### Accessories

Replacement plug	Type	Order No.	Pcs./Pkt.
L-N / L-PEN	FLT-SEC-P-T1-440/35-P	2905989	1
N-PE	FLT-SEC-P-T1-N/PE-440/100-P	2907263	1

#### Technical data

Electrical data	
IEC test classification	I / II, T1 / T2
Nominal voltage $U_N$	400/690 V AC (TN-C) / 400 V AC (IT)
Mode of protection	
Maximum continuous operating voltage $U_C$	L-PE / L-PEN 440 V AC
Impulse discharge current $I_{imp}$ (10/350) $\mu$ s	35 kA
Nominal discharge current $I_n$ (8/20) $\mu$ s	35 kA
Max. discharge current $I_{max}$ (8/20) $\mu$ s	50 kA
Protection level $U_p$	$\leq 2.5$ kV
Follow current interrupt rating $I_{fi}$	50 kA
Response time $t_A$	$\leq 100$ ns
Short-circuit current rating $I_{SCCR}$	50 kA
Max. backup fuse with branch wiring	400 A (gG)
General data	
Dimensions W/H/D	106.8 mm / 95.2 mm / 74.5 mm
IEC connection data	2.5 ... 35 mm <sup>2</sup> / 2.5 ... 35 mm <sup>2</sup> / 13 ... 2
Temperature range	-40 °C ... 80 °C
Test standards	IEC 61643-11 / EN 61643-11
Remote indication contact	PDT contact
IEC connection data	0.14 ... 1.5 mm <sup>2</sup> / 0.14 ... 1.5 mm <sup>2</sup> / 28 ... 16
Max. operating voltage	250 V AC / 125 V DC (200 mA DC)
Max. operating current	1 A AC / 1 A DC (30 V DC)

#### Ordering data

Description	Type	Order No.	Pcs./Pkt.
FLASHTRAB	FLT-SEC-P-T1-3C-440/35-FM	2905988	1

#### Accessories

Replacement plug	Type	Order No.	Pcs./Pkt.
L-N / L-PEN	FLT-SEC-P-T1-440/35-P	2905989	1

# Surge protection and interference suppression filters

## Surge protection for the power supply

### Type 1/2 combination protective device FLASHTRAB SEC PLUS 440

- Spark gap has no line follow current
- Free of leakage current, suitable for use in the pre-meter area
- Satisfies TOV requirements for use in IT systems
- Pluggable
- Low voltage protection level of 2.5 kV
- Optical, mechanical status indicator
- With floating remote indication contact
- Plugs can be checked with CHECKMASTER



2-conductor system,  
L, PE(N)



N-PE spark gap

new

#### Notes:

If only one value is specified under mode of protection in the technical data, this value is valid for all modes of protection specified.

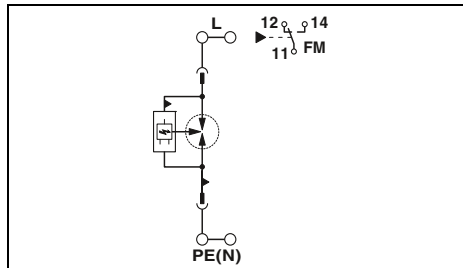

#### Technical data

I / II, T1 / T2  
400 V AC (TN) /  
400 V AC (IT)  
L-N / L-PE / L-PEN / N-PE (4+0)  
440 V AC  
35 kA  
35 kA  
50 kA  
≤ 2.5 kV  
100 A  
≤ 100 ns  
50 kA  
400 A (gG)

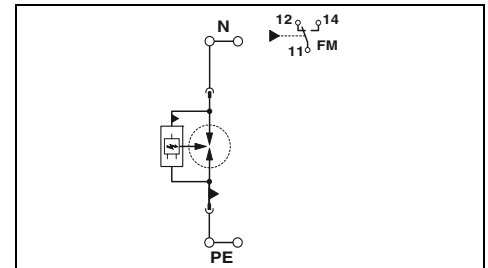

#### Technical data

I / II, T1 / T2  
400 V AC (TN - only N-PE) /  
400 V AC (TT - only N-PE)  
N-PE  
440 V AC  
100 kA  
100 kA  
-  
≤ 2.5 kV  
100 A  
≤ 100 ns  
-  
-

<b>Electrical data</b>	
IEC test classification	
Nominal voltage $U_N$	
<b>Mode of protection</b>	
Maximum continuous operating voltage $U_C$	
Impulse discharge current $I_{imp}$ (10/350) $\mu$ s	
Nominal discharge current $I_n$ (8/20) $\mu$ s	
Max. discharge current $I_{max}$ (8/20) $\mu$ s	
Protection level $U_p$	
Follow current interrupt rating $I_f$	
Response time $t_A$	
Short-circuit current rating $I_{SCCR}$	
Max. backup fuse with branch wiring	
<b>General data</b>	
Dimensions W/H/D	
IEC connection data	Solid/stranded/AWG
Temperature range	
Test standards	
<b>Remote indication contact</b>	
IEC connection data	Solid/stranded/AWG
Max. operating voltage	
Max. operating current	

Dimensions W/H/D	35.6 mm / 95.2 mm / 74.5 mm
IEC connection data	2.5 ... 35 mm <sup>2</sup> / 2.5 ... 35 mm <sup>2</sup> / 13 ... 2
Temperature range	-40 °C ... 80 °C
Test standards	IEC 61643-11 / EN 61643-11
<b>Remote indication contact</b>	
IEC connection data	0.14 ... 1.5 mm <sup>2</sup> / 0.14 ... 1.5 mm <sup>2</sup> / 28 ... 16
Max. operating voltage	250 V AC / 125 V DC (200 mA DC)
Max. operating current	1 A AC / 1 A DC (30 V DC)

Dimensions W/H/D	35.6 mm / 95.2 mm / 74.5 mm
IEC connection data	2.5 ... 35 mm <sup>2</sup> / 2.5 ... 35 mm <sup>2</sup> / 13 ... 2
Temperature range	-40 °C ... 80 °C
Test standards	IEC 61643-11 / EN 61643-11
<b>Remote indication contact</b>	
IEC connection data	0.14 ... 1.5 mm <sup>2</sup> / 0.14 ... 1.5 mm <sup>2</sup> / 28 ... 16
Max. operating voltage	250 V AC / 125 V DC (200 mA DC)
Max. operating current	1 A AC / 1 A DC (30 V DC)

<b>Description</b>	
FLASHTRAB	
<b>Replacement plug</b>	
	L-N / L-PEN N-PE

Ordering data		
Type	Order No.	Pcs./Pkt.
FLT-SEC-P-T1-1C-440/35-FM	2905987	1

Accessories		
Type	Order No.	Pcs./Pkt.
FLT-SEC-P-T1-440/35-P	2905989	1

Ordering data		
Type	Order No.	Pcs./Pkt.
FLT-SEC-P-T1-N/PE-440/100-FM	2907262	1

Accessories		
Type	Order No.	Pcs./Pkt.
FLT-SEC-P-T1-N/PE-440/100-P	2907263	1

### Type 1/2 combination protective device FLASHTRAB SEC PLUS 350

- Spark gap has no line follow current
- Free of leakage current, suitable for use in the pre-meter area
- Pluggable
- High continuous voltage of 350 V AC for 230/400 V AC networks with high voltage fluctuations
- Low voltage protection level of 1.5 kV
- Optical, mechanical status indicator
- With floating remote indication contact
- Plugs can be checked with CHECKMASTER



5-conductor system;  
L1, L2, L3, N, PE



4-conductor system;  
L1, L2, L3, PEN

#### Notes:

If only one value is specified under mode of protection in the technical data, this value is valid for all modes of protection specified.

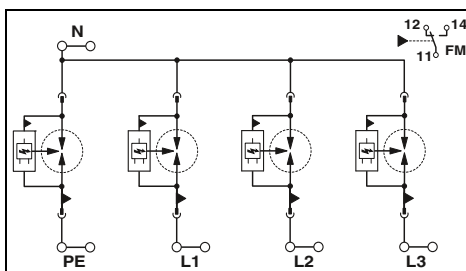

#### Technical data

I / II, T1 / T2  
240/415 V AC (TN-S) /  
240/415 V AC (TT)  
L-N / L-PE / N-PE  
350 V AC  
25 kA / 25 kA / 100 kA  
25 kA / 25 kA / 100 kA  
50 kA / 50 kA / -  
≤ 1.5 kV / ≤ 2.5 kV / ≤ 1.5 kV  
50 kA / - / 100 A  
≤ 100 ns  
50 kA  
315 A (gG)

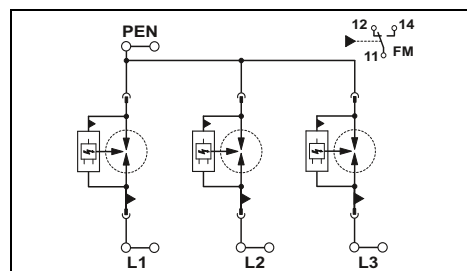

#### Technical data

I / II, T1 / T2  
240/415 V AC (TN-C)  
L-PEN  
350 V AC  
25 kA  
25 kA  
50 kA  
≤ 1.5 kV  
50 kA  
≤ 100 ns  
50 kA  
315 A (gG)

<b>Electrical data</b>	
IEC test classification	
Nominal voltage $U_N$	
<b>Mode of protection</b>	
Maximum continuous operating voltage $U_C$	350 V AC
Impulse discharge current $I_{imp}$ (10/350) $\mu$ s	25 kA / 25 kA / 100 kA
Nominal discharge current $I_n$ (8/20) $\mu$ s	25 kA / 25 kA / 100 kA
Max. discharge current $I_{max}$ (8/20) $\mu$ s	50 kA / 50 kA / -
Protection level $U_p$	≤ 1.5 kV / ≤ 2.5 kV / ≤ 1.5 kV
Follow current interrupt rating $I_{fi}$	50 kA / - / 100 A
Response time $t_A$	≤ 100 ns
Short-circuit current rating $I_{SCCR}$	50 kA
Max. backup fuse with branch wiring	315 A (gG)
<b>General data</b>	
Dimensions W/H/D	142.4 mm / 95.2 mm / 74.5 mm
IEC connection data	Solid/stranded/AWG
UL connection data	AWG
Temperature range	-40 °C ... 80 °C
Test standards	IEC 61643-11 / EN 61643-11
<b>Remote indication contact</b>	
IEC connection data	Solid/stranded/AWG
UL connection data	AWG
Max. operating voltage	250 V AC / 125 V DC (200 mA DC)
Max. operating current	1 A AC / 1 A DC (30 V DC)

<b>General data</b>	
Dimensions W/H/D	142.4 mm / 95.2 mm / 74.5 mm
IEC connection data	Solid/stranded/AWG
UL connection data	AWG
Temperature range	-40 °C ... 80 °C
Test standards	IEC 61643-11 / EN 61643-11
<b>Remote indication contact</b>	
IEC connection data	Solid/stranded/AWG
UL connection data	AWG
Max. operating voltage	250 V AC / 125 V DC (200 mA DC)
Max. operating current	1 A AC / 1 A DC (30 V DC)

<b>Description</b>	<b>FLASHTRAB</b>
--------------------	------------------

<b>Ordering data</b>			
<b>Type</b>	<b>Order No.</b>	<b>Pcs./Pkt.</b>	
FLT-SEC-P-T1-3S-350/25-FM	2905421	1	

<b>Replacement plug</b>	L-N / L-PEN N-PE
-------------------------	---------------------

<b>Accessories</b>			
	<b>Type</b>	<b>Order No.</b>	<b>Pcs./Pkt.</b>
	FLT-SEC-P-T1-350/25-P	2905422	1
	FLT-SEC-P-T1-N/PE-350/100-P	2905473	1

<b>Ordering data</b>			
<b>Type</b>	<b>Order No.</b>	<b>Pcs./Pkt.</b>	
FLT-SEC-P-T1-3C-350/25-FM	2905419	1	

<b>Accessories</b>			
	<b>Type</b>	<b>Order No.</b>	<b>Pcs./Pkt.</b>
	FLT-SEC-P-T1-350/25-P	2905422	1

# Surge protection and interference suppression filters

## Surge protection for the power supply

### Type 1/2 combination protective device FLASHTRAB SEC PLUS 350

- Spark gap has no line follow current
- Free of leakage current, suitable for use in the pre-meter area
- Pluggable
- High continuous voltage of 350 V AC for 230/400 V AC networks with high voltage fluctuations
- Low voltage protection level of 1.5 kV
- Optical, mechanical status indicator
- With floating remote indication contact
- Plugs can be checked with CHECKMASTER



4-conductor system;  
L1, L2, N, PE



3-conductor system;  
L1, L2, PEN

#### Notes:

If only one value is specified under mode of protection in the technical data, this value is valid for all modes of protection specified.

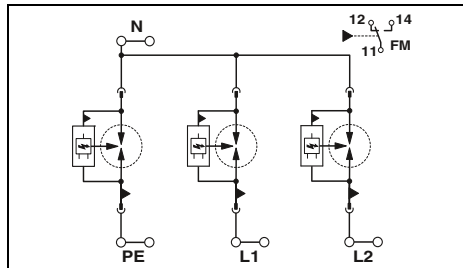

#### Technical data

I / II, T1 / T2  
240/415 V AC (TN-S) /  
240/415 V AC (TT)  
L-N / L-PE / N-PE  
350 V AC  
25 kA / 25 kA / 100 kA  
25 kA / 25 kA / 100 kA  
50 kA / 50 kA / -  
≤ 1.5 kV / ≤ 2.5 kV / ≤ 1.5 kV  
50 kA / - / 100 A  
≤ 100 ns  
50 kA  
315 A (gG)

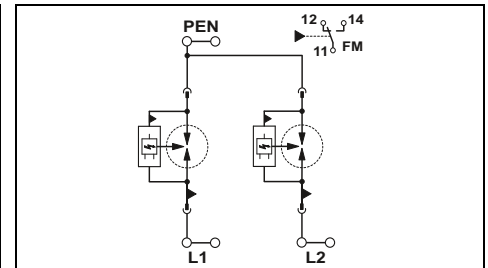

#### Technical data

I / II, T1 / T2  
240/415 V AC (TN-C)  
L-PEN  
350 V AC  
25 kA  
25 kA  
50 kA  
≤ 1.5 kV  
50 kA  
≤ 100 ns  
50 kA  
315 A (gG)

<b>Electrical data</b>	
IEC test classification	
Nominal voltage $U_N$	
<b>Mode of protection</b>	
Maximum continuous operating voltage $U_C$	
Impulse discharge current $I_{imp}$ (10/350) $\mu$ s	
Nominal discharge current $I_n$ (8/20) $\mu$ s	
Max. discharge current $I_{max}$ (8/20) $\mu$ s	
Protection level $U_p$	
Follow current interrupt rating $I_{fi}$	
Response time $t_A$	
Short-circuit current rating $I_{SCCR}$	
Max. backup fuse with branch wiring	
<b>General data</b>	
Dimensions W/H/D	
IEC connection data	Solid/stranded/AWG
UL connection data	AWG
Temperature range	
Test standards	
<b>Remote indication contact</b>	
IEC connection data	Solid/stranded/AWG
UL connection data	AWG
Max. operating voltage	
Max. operating current	

106.8 mm / 95.2 mm / 74.5 mm  
2.5 ... 35 mm<sup>2</sup> / 2.5 ... 35 mm<sup>2</sup> / 13 ... 2  
12 ... 2  
-40 °C ... 80 °C  
IEC 61643-11 / EN 61643-11  
PDT contact  
0.14 ... 1.5 mm<sup>2</sup> / 0.14 ... 1.5 mm<sup>2</sup> / 28 ... 16  
30 ... 14  
250 V AC / 125 V DC (200 mA DC)  
1 A AC / 1 A DC (30 V DC)

71.2 mm / 95.2 mm / 74.5 mm  
2.5 ... 35 mm<sup>2</sup> / 2.5 ... 35 mm<sup>2</sup> / 13 ... 2  
12 ... 2  
-40 °C ... 80 °C  
IEC 61643-11 / EN 61643-11  
PDT contact  
0.14 ... 1.5 mm<sup>2</sup> / 0.14 ... 1.5 mm<sup>2</sup> / 28 ... 16  
30 ... 14  
250 V AC / 125 V DC (200 mA DC)  
1 A AC / 1 A DC (30 V DC)

#### Ordering data

Description	Type	Order No.	Pcs./Pkt.
FLASHTRAB	FLT-SEC-P-T1-2S-350/25-FM	2905418	1

#### Accessories

Replacement plug	Type	Order No.	Pcs./Pkt.
L-N / L-PEN	FLT-SEC-P-T1-350/25-P	2905422	1
N-PE	FLT-SEC-P-T1-N/PE-350/100-P	2905473	1

#### Ordering data

Description	Type	Order No.	Pcs./Pkt.
FLASHTRAB	FLT-SEC-P-T1-2C-350/25-FM	2905416	1

#### Accessories

Replacement plug	Type	Order No.	Pcs./Pkt.
L-PEN	FLT-SEC-P-T1-350/25-P	2905422	1



**3-conductor system;**  
L, N, PE



**2-conductor system;**  
L, PEN



**N-PE spark gap**

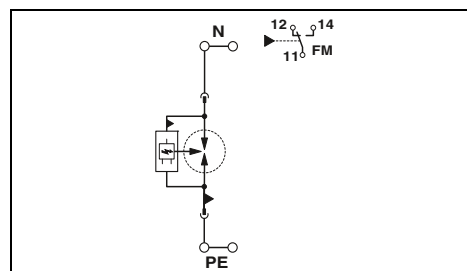
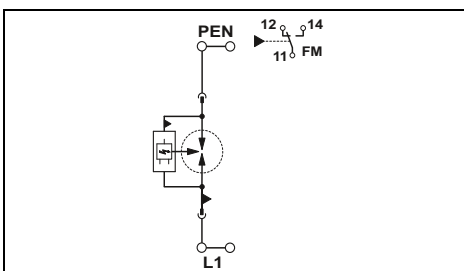
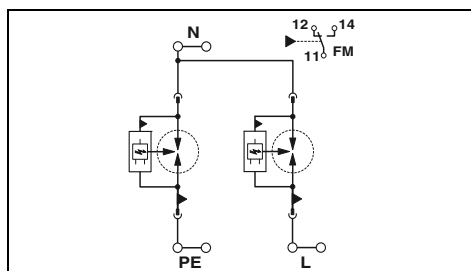

### Technical data

I/II, T1/T2  
240 V AC (TN-S) /  
240 V AC (TT)  
L-N / L-PE / N-PE  
350 V AC  
25 kA / 25 kA / 100 kA  
25 kA / 25 kA / 100 kA  
50 kA / 50 kA / -  
≤ 1.5 kV / ≤ 2.5 kV / ≤ 1.5 kV  
50 kA / - / 100 A  
≤ 100 ns  
50 kA  
315 A (gG)

71.2 mm / 95.2 mm / 74.5 mm  
2.5 ... 35 mm<sup>2</sup> / 2.5 ... 35 mm<sup>2</sup> / 13 ... 2  
12 ... 2  
-40 °C ... 80 °C  
IEC 61643-11 / EN 61643-11  
PDT contact  
0.14 ... 1.5 mm<sup>2</sup> / 0.14 ... 1.5 mm<sup>2</sup> / 28 ... 16  
30 ... 14  
250 V AC / 125 V DC (200 mA DC)  
1 A AC / 1 A DC (30 V DC)

### Ordering data

Type	Order No.	Pcs./Pkt.
FLT-SEC-P-T1-1S-350/25-FM	2905415	1

### Accessories

FLT-SEC-P-T1-350/25-P	2905422	1
FLT-SEC-P-T1-N/PE-350/100-P	2905473	1

### Technical data

I/II, T1/T2  
240 V AC (TN-C) /  
240 V AC (TT)  
L-PEN  
350 V AC  
25 kA  
25 kA  
50 kA  
≤ 1.5 kV  
50 kA  
≤ 100 ns  
50 kA  
315 A (gG)

35.6 mm / 95.2 mm / 74.5 mm  
2.5 ... 35 mm<sup>2</sup> / 2.5 ... 35 mm<sup>2</sup> / 13 ... 2  
12 ... 2  
-40 °C ... 80 °C  
IEC 61643-11 / EN 61643-11  
PDT contact  
0.14 ... 1.5 mm<sup>2</sup> / 0.14 ... 1.5 mm<sup>2</sup> / 28 ... 16  
30 ... 14  
250 V AC / 125 V DC (200 mA DC)  
1 A AC / 1 A DC (30 V DC)

### Ordering data

Type	Order No.	Pcs./Pkt.
FLT-SEC-P-T1-1C-350/25-FM	2905414	1

### Accessories

FLT-SEC-P-T1-350/25-P	2905422	1
-----------------------	---------	---

### Technical data

I/II, T1/T2  
240 V AC (TN - only N-PE) /  
240 V AC (TT - only N-PE)  
N-PE  
350 V AC  
100 kA  
100 kA  
-  
≤ 1.5 kV  
100 A  
≤ 100 ns  
-

35.6 mm / 95.2 mm / 74.5 mm  
2.5 ... 35 mm<sup>2</sup> / 2.5 ... 35 mm<sup>2</sup> / 13 ... 2  
12 ... 2  
-40 °C ... 80 °C  
IEC 61643-11 / EN 61643-11  
PDT contact  
0.14 ... 1.5 mm<sup>2</sup> / 0.14 ... 1.5 mm<sup>2</sup> / 28 ... 16  
30 ... 14  
250 V AC / 125 V DC (200 mA DC)  
1 A AC / 1 A DC (30 V DC)

### Ordering data

Type	Order No.	Pcs./Pkt.
FLT-SEC-P-T1-N/PE-350/100-FM	2905472	1

### Accessories

FLT-SEC-P-T1-N/PE-350/100-P	2905473	1
-----------------------------	---------	---

# Surge protection and interference suppression filters

## Surge protection for the power supply

### Type 1/2 combination protective device FLASHTRAB SEC PLUS 264

- Spark gap has no line follow current
- Free of leakage current, suitable for use in the pre-meter area
- Pluggable
- High lightning impulse current of 50 kA per position
- Low voltage protection level of 2.5 kV
- Optical, mechanical status indicator
- With floating remote indication contact
- Plugs can be checked with CHECKMASTER

#### Notes:

If only one value is specified under mode of protection in the technical data, this value is valid for all modes of protection specified.



5-conductor system;  
L1, L2, L3, N, PE



4-conductor system;  
L1, L2, L3, PEN

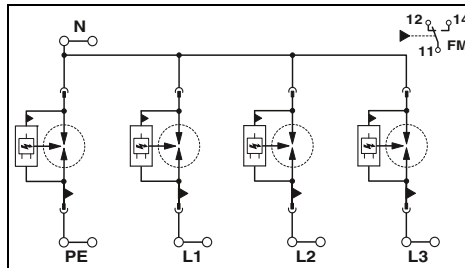

#### Technical data

I / II, T1 / T2  
240/415 V AC (TN-S) /  
240/415 V AC (TT)  
L-N / L-PE / N-PE  
264 V AC / 264 V AC / 350 V AC  
50 kA / 50 kA / 100 kA  
50 kA / 50 kA / 100 kA  
100 kA  
 $\leq 2.5 \text{ kV} / \leq 3 \text{ kV} / \leq 1.5 \text{ kV}$   
50 kA / - / 100 A  
 $\leq 100 \text{ ns}$   
50 kA  
500 A (gG)

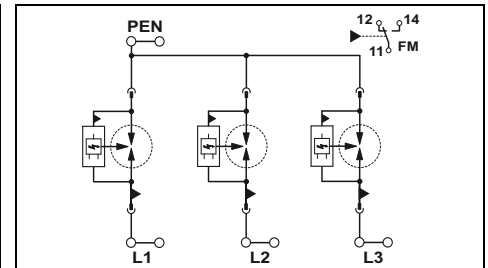

#### Technical data

I / II, T1 / T2  
240/415 V AC (TN-C)  
L-PEN  
264 V AC  
50 kA  
50 kA  
100 kA  
 $\leq 2.5 \text{ kV}$   
50 kA  
 $\leq 100 \text{ ns}$   
50 kA  
500 A (gG)

#### Electrical data

IEC test classification  
Nominal voltage  $U_N$   
Mode of protection  
Maximum continuous operating voltage  $U_C$   
Impulse discharge current  $I_{imp}$  (10/350)  $\mu\text{s}$   
Nominal discharge current  $I_n$  (8/20)  $\mu\text{s}$   
Max. discharge current  $I_{max}$  (8/20)  $\mu\text{s}$   
Protection level  $U_p$   
Follow current interrupt rating  $I_{fi}$   
Response time  $t_A$   
Short-circuit current rating  $I_{SCCR}$   
Max. backup fuse with branch wiring

#### General data

Dimensions W/H/D  
IEC connection data Solid/stranded/AWG  
UL connection data AWG  
Temperature range  
Test standards  
Remote indication contact  
IEC connection data Solid/stranded/AWG  
UL connection data AWG  
Max. operating voltage  
Max. operating current

142.4 mm / 95.2 mm / 74.5 mm  
2.5 ... 35 mm<sup>2</sup> / 2.5 ... 35 mm<sup>2</sup> / 13 ... 2  
-40 °C ... 80 °C  
IEC 61643-11 / EN 61643-11  
PDT contact  
0.14 ... 1.5 mm<sup>2</sup> / 0.14 ... 1.5 mm<sup>2</sup> / 28 ... 16  
-  
250 V AC / 125 V DC (200 mA DC)  
1 A AC / 1 A DC (30 V DC)

106.8 mm / 95.2 mm / 74.5 mm  
2.5 ... 35 mm<sup>2</sup> / 2.5 ... 35 mm<sup>2</sup> / 13 ... 2  
-40 °C ... 80 °C  
IEC 61643-11 / EN 61643-11  
PDT contact  
0.14 ... 1.5 mm<sup>2</sup> / 0.14 ... 1.5 mm<sup>2</sup> / 28 ... 16  
-  
250 V AC / 125 V DC (200 mA DC)  
1 A AC / 1 A DC (30 V DC)

#### Ordering data

Type	Order No.	Pcs./Pkt.
FLASHTRAB		
FLT-SEC-P-T1-3S-264/50-FM	2909589	1

#### Accessories

Type	Order No.	Pcs./Pkt.
Replacement plug L-N / L-PEN	2907391	5
Replacement plug N-PE	2905473	1

#### Ordering data

Type	Order No.	Pcs./Pkt.
FLASHTRAB		
FLT-SEC-P-T1-3C-264/50-FM	2907390	1

#### Accessories

Type	Order No.	Pcs./Pkt.
Replacement plug	2907391	5



new



3-conductor system;  
L, N, PE



new



2-conductor system;  
L, PEN



new



N-PE spark gap

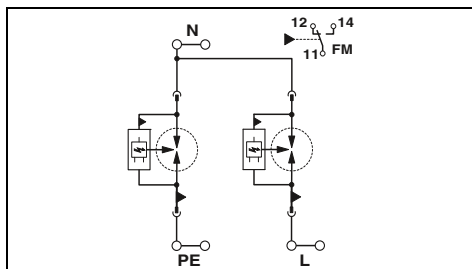

### Technical data

I/II, T1/T2  
240 V AC (TN-S) /  
240 V AC (TT)  
L-N / L-PE / N-PE  
264 V AC / 264 V AC / 350 V AC  
50 kA / 50 kA / 100 kA  
50 kA / 50 kA / 100 kA  
100 kA  
≤ 2.5 kV / ≤ 3 kV / ≤ 1.5 kV  
50 kA / - / 100 A  
≤ 100 ns  
50 kA  
500 A (gG)

71.2 mm / 95.2 mm / 74.5 mm  
2.5 ... 35 mm<sup>2</sup> / 2.5 ... 35 mm<sup>2</sup> / 13 ... 2  
-  
-40 °C ... 80 °C  
IEC 61643-11 / EN 61643-11  
PDT contact  
0.14 ... 1.5 mm<sup>2</sup> / 0.14 ... 1.5 mm<sup>2</sup> / 28 ... 16  
-  
250 V AC / 125 V DC (200 mA DC)  
1 A AC / 1 A DC (30 V DC)

### Ordering data

Type	Order No.	Pcs./Pkt.
FLT-SEC-P-T1-1S-264/50-FM	2907388	1

### Accessories

FLT-SEC-P-T1-264/50-P	2907391	5
FLT-SEC-P-T1-N/PE-350/100-P	2905473	1

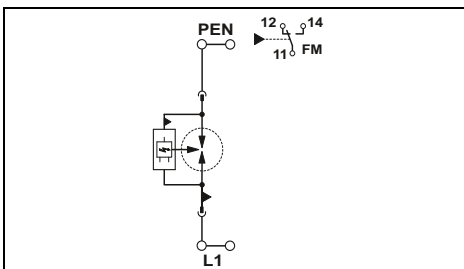

### Technical data

I/II, T1/T2  
240 V AC (TN-C) /  
240 V AC (TT)  
L-PEN  
264 V AC  
50 kA  
50 kA  
100 kA  
≤ 2.5 kV  
50 kA  
≤ 100 ns  
50 kA  
500 A (gG)

35.6 mm / 95.2 mm / 74.5 mm  
2.5 ... 35 mm<sup>2</sup> / 2.5 ... 35 mm<sup>2</sup> / 13 ... 2  
-  
-40 °C ... 80 °C  
IEC 61643-11 / EN 61643-11  
PDT contact  
0.14 ... 1.5 mm<sup>2</sup> / 0.14 ... 1.5 mm<sup>2</sup> / 28 ... 16  
-  
250 V AC / 125 V DC (200 mA DC)  
1 A AC / 1 A DC (30 V DC)

### Ordering data

Type	Order No.	Pcs./Pkt.
FLT-SEC-P-T1-1C-264/50-FM	2907387	1

### Accessories

FLT-SEC-P-T1-264/50-P	2907391	5
-----------------------	---------	---

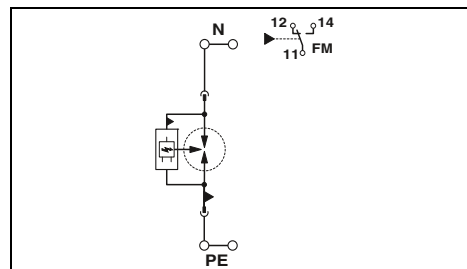

### Technical data

I/II, T1/T2  
240 V AC (TN - only N-PE) /  
240 V AC (TT - only N-PE)  
N-PE  
350 V AC  
100 kA  
100 kA  
-  
≤ 1.5 kV  
100 A  
≤ 100 ns  
-  
-

35.6 mm / 95.2 mm / 74.5 mm  
2.5 ... 35 mm<sup>2</sup> / 2.5 ... 35 mm<sup>2</sup> / 13 ... 2  
12 ... 2  
-40 °C ... 80 °C  
IEC 61643-11 / EN 61643-11  
PDT contact  
0.14 ... 1.5 mm<sup>2</sup> / 0.14 ... 1.5 mm<sup>2</sup> / 28 ... 16  
30 ... 14  
250 V AC / 125 V DC (200 mA DC)  
1 A AC / 1 A DC (30 V DC)

### Ordering data

Type	Order No.	Pcs./Pkt.
FLT-SEC-P-T1-N/PE-350/100-FM	2905472	1

### Accessories

FLT-SEC-P-T1-N/PE-350/100-P	2905473	1
-----------------------------	---------	---

# Surge protection and interference suppression filters

## Surge protection for the power supply

### Type 1/2 combination protective device VALVETRAB MS

- Consistent pluggability (even for N/PE spark gap)
- Secure hold of plugs in the event of high lightning current loads and strong vibration thanks to new latching
- Thermal disconnect device for each individual connector
- Optical, mechanical status indication for the individual arresters
- With or without floating remote indication contact
- Mechanical coding of all slots
- Plugs can be checked with CHECKMASTER



5-conductor system;  
L1, L2, L3, N, PE (3+1 circuit)



5-conductor system;  
L1, L2, L3, N, PE (4+0 circuit)

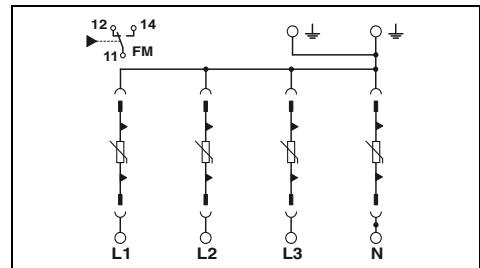
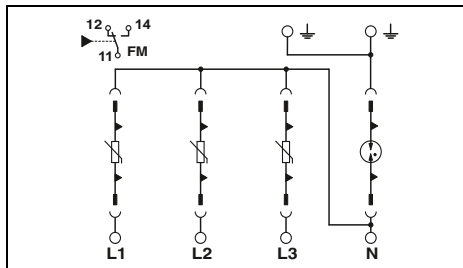

**Notes:**  
If only one value is specified under mode of protection in the technical data, this value is valid for all modes of protection specified.

**Electrical data**  
IEC test classification  
Nominal voltage  $U_N$

**Mode of protection**  
Maximum continuous operating voltage  $U_C$   
Impulse discharge current  $I_{imp}$  (10/350)  $\mu$ s  
Nominal discharge current  $I_n$  (8/20)  $\mu$ s  
Max. discharge current  $I_{max}$  (8/20)  $\mu$ s  
Protection level  $U_p$   
Response time  $t_A$   
Short-circuit current rating  $I_{SCCR}$   
Max. backup fuse with branch wiring

Technical data	
...	335
I / II, T1 / T2	240/415 V AC (TN-S) / 240/415 V AC (TT)
L-N / L-PE / N-PE	L-N / L-PE / N-PE
335 V AC / 335 V AC / 264 V AC	335 V AC / 335 V AC / 264 V AC
12.5 kA / 12.5 kA / 50 kA	12.5 kA / 12.5 kA / 50 kA
12.5 kA / 12.5 kA / 50 kA	12.5 kA / 12.5 kA / 50 kA
50 kA	50 kA
$\leq 1.2$ kV / $\leq 2$ kV / $\leq 1.7$ kV	$\leq 1.2$ kV / $\leq 2$ kV / $\leq 1.7$ kV
$\leq 25$ ns / $\leq 100$ ns / $\leq 100$ ns	$\leq 25$ ns / $\leq 100$ ns / $\leq 100$ ns
25 kA	25 kA
160 A (gG)	160 A (gG)

Technical data	
...	335
I / II, T1 / T2	240/415 V AC (TN-S)
L-PE / N-PE	L-PE / N-PE
335 V AC	335 V AC
12.5 kA	12.5 kA
12.5 kA	12.5 kA
50 kA	50 kA
$\leq 1.2$ kV	$\leq 1.2$ kV
$\leq 25$ ns	$\leq 25$ ns
25 kA	25 kA
160 A (gG)	160 A (gG)

**General data**  
Dimensions W/H/D  
IEC connection data  
UL connection data  
Temperature range  
Test standards  
Remote indication contact  
IEC connection data  
UL connection data  
Max. operating voltage  
Max. operating current

71.2 mm / 99 mm / 77.5 mm	71.2 mm / 99 mm / 77.5 mm
1.5 ... 35 mm <sup>2</sup> / 1.5 ... 25 mm <sup>2</sup> / 15 ... 2	1.5 ... 35 mm <sup>2</sup> / 1.5 ... 25 mm <sup>2</sup> / 15 ... 2
10 ... 2	10 ... 2
-40 °C ... 80 °C	-40 °C ... 80 °C
IEC 61643-11 / EN 61643-11	IEC 61643-11 / EN 61643-11
PDT contact	PDT contact
0.14 ... 1.5 mm <sup>2</sup> / 0.14 ... 1.5 mm <sup>2</sup> / 28 ... 16	0.14 ... 1.5 mm <sup>2</sup> / 0.14 ... 1.5 mm <sup>2</sup> / 28 ... 16
30 ... 14	30 ... 14
250 V AC / 30 V DC	250 V AC / 30 V DC
1.5 A AC / 1 A DC	1.5 A AC / 1 A DC

71.2 mm / 99 mm / 77.5 mm	71.2 mm / 99 mm / 77.5 mm
1.5 ... 35 mm <sup>2</sup> / 1.5 ... 25 mm <sup>2</sup> / 15 ... 2	1.5 ... 35 mm <sup>2</sup> / 1.5 ... 25 mm <sup>2</sup> / 15 ... 2
10 ... 2	10 ... 2
-40 °C ... 80 °C	-40 °C ... 80 °C
IEC 61643-11 / EN 61643-11	IEC 61643-11 / EN 61643-11
PDT contact	PDT contact
0.14 ... 1.5 mm <sup>2</sup> / 0.14 ... 1.5 mm <sup>2</sup> / 28 ... 16	0.14 ... 1.5 mm <sup>2</sup> / 0.14 ... 1.5 mm <sup>2</sup> / 28 ... 16
30 ... 14	30 ... 14
250 V AC / 30 V DC	250 V AC / 30 V DC
1.5 A AC / 1 A DC	1.5 A AC / 1 A DC

Description	$U_C$
<b>VALVETRAB-MS</b> , varistor-based lightning current arrester	
with remote indication contact	335 V AC
without remote indication contact	335 V AC
	175 V AC

Ordering data			
Type	Order No.	Pcs./Pkt.	
VAL-MS-T1/T2 335/12.5/3+1-FM	2800183	1	
VAL-MS-T1/T2 335/12.5/3+1	2800184	1	

Ordering data			
Type	Order No.	Pcs./Pkt.	
VAL-MS-T1/T2 335/12.5/4+0-FM	2800644	1	
VAL-MS-T1/T2 335/12.5/4+0	2800645	1	

Replacement plug	
335 V AC	L-N / L-PEN
175 V AC	L-N / L-PEN N-PE

Accessories			
VAL-MS-T1/T2 335/12.5 ST	2800190	10	
F-MS-T1/T2 50 ST	2800191	10	

Accessories			
VAL-MS-T1/T2 335/12.5 ST	2800190	10	



4-conductor system;  
L1, L2, L3, PEN



3-conductor system;  
L, N, PE



2-conductor system;  
L, N, PEN

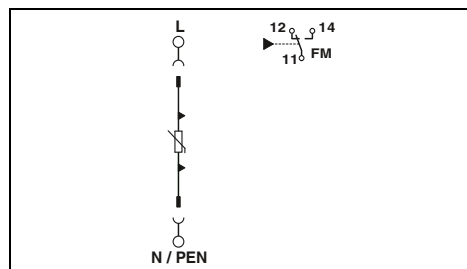
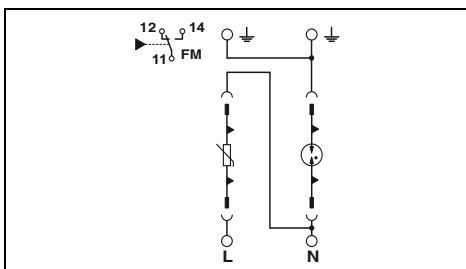
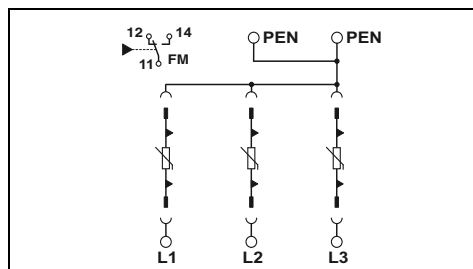

### Technical data

...335	...175
I / II, T1 / T2	I / II, T1 / T2
240/415 V AC (TN-C)	120/208 V AC (TN-C)
L-PEN	L-PEN
335 V AC	175 V AC
12.5 kA	12.5 kA
12.5 kA	12.5 kA
50 kA	50 kA
≤ 1.2 kV	≤ 0.8 kV
≤ 25 ns	≤ 25 ns
25 kA	25 kA
160 A (gG)	160 A (gG)

### Technical data

...335	...175
I / II, T1 / T2	I / II, T1 / T2
240 V AC (TN-S) / 240 V AC (TT)	120 V AC (TN-S) / 120 V AC (TT)
L-N / L-PE / N-PE	L-N / L-PE / N-PE
335 V AC / 335 V AC / 264 V AC	175 V AC / 175 V AC / 264 V AC
12.5 kA / 12.5 kA / 50 kA	12.5 kA / 12.5 kA / 50 kA
12.5 kA / 12.5 kA / 50 kA	12.5 kA / 12.5 kA / 50 kA
50 kA	50 kA
≤ 1.2 kV / ≤ 2 kV / ≤ 1.7 kV	≤ 0.8 kV / ≤ 2 kV / ≤ 1.7 kV
≤ 25 ns / ≤ 100 ns / ≤ 100 ns	≤ 25 ns / ≤ 100 ns / ≤ 100 ns
25 kA	25 kA
160 A (gG)	160 A (gG)

### Technical data

...335
I / II, T1 / T2
240 V AC (TN-C, TN-S) / 240 V AC (TT)
L-N / L-PE
335 V AC
12.5 kA
12.5 kA
50 kA
≤ 1.2 kV
≤ 25 ns
25 kA
160 A (gG)

53.4 mm / 99 mm / 77.5 mm  
1.5 ... 35 mm<sup>2</sup> / 1.5 ... 25 mm<sup>2</sup> / 15 ... 2

-40 °C ... 80 °C  
IEC 61643-11 / EN 61643-11

PDT contact  
0.14 ... 1.5 mm<sup>2</sup> / 0.14 ... 1.5 mm<sup>2</sup> / 28 ... 16

30 ... 14  
250 V AC / 30 V DC  
1.5 A AC / 1 A DC

35.6 mm / 99 mm / 77.5 mm  
1.5 ... 35 mm<sup>2</sup> / 1.5 ... 25 mm<sup>2</sup> / 15 ... 2

-40 °C ... 80 °C  
IEC 61643-11 / EN 61643-11

PDT contact  
0.14 ... 1.5 mm<sup>2</sup> / 0.14 ... 1.5 mm<sup>2</sup> / 28 ... 16

30 ... 14  
250 V AC / 30 V DC  
1.5 A AC / 1 A DC

17.5 mm / 99 mm / 77.5 mm  
1.5 ... 35 mm<sup>2</sup> / 1.5 ... 25 mm<sup>2</sup> / 15 ... 2

-40 °C ... 80 °C  
IEC 61643-11 / EN 61643-11

PDT contact  
0.14 ... 1.5 mm<sup>2</sup> / 0.14 ... 1.5 mm<sup>2</sup> / 28 ... 16

-  
250 V AC / 30 V DC  
1 A AC / 1 A DC

### Ordering data

Type	Order No.	Pcs./Pkt.
VAL-MS-T1/T2 335/12.5/3+0-FM	2800188	1
VAL-MS-T1/T2 335/12.5/3+0	2800189	1
VAL-MS-T1/T2 175/12.5/3+0-FM	2800672	1

### Accessories

VAL-MS-T1/T2 335/12.5 ST	2800190	10
VAL-MS-T1/T2 175/12.5 ST	2800676	10

### Ordering data

Type	Order No.	Pcs./Pkt.
VAL-MS-T1/T2 335/12.5/1+1-FM	2800186	1
VAL-MS-T1/T2 335/12.5/1+1	2800187	1
VAL-MS-T1/T2 175/12.5/1+1-FM	2800674	1

### Accessories

VAL-MS-T1/T2 335/12.5 ST	2800190	10
VAL-MS-T1/T2 175/12.5 ST	2800676	10
F-MS-T1/T2 50 ST	2800191	10

### Ordering data

Type	Order No.	Pcs./Pkt.
VAL-MS-T1/T2 335/12.5/1+0-FM	2801042	1
VAL-MS-T1/T2 335/12.5/1+0	2801041	1

### Accessories

VAL-MS-T1/T2 335/12.5 ST	2800190	10
--------------------------	---------	----

# Surge protection and interference suppression filters

## Surge protection for the power supply

### Type 1/2 combination protective device VALVETRAB MS

- Universal pluggability
- Thermal disconnect device for each individual connector
- Optical, mechanical status indication for the individual arresters
- With or without floating remote indication contact
- Mechanical coding of all slots
- Plugs can be checked with CHECKMASTER

**Notes:**  
If only one value is specified under mode of protection in the technical data, this value is valid for all modes of protection specified.



2-conductor system;  
L, PEN

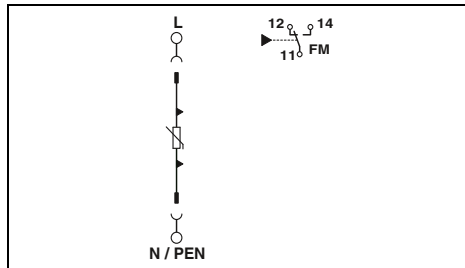

#### Technical data

<b>Electrical data</b>	
IEC test classification	I / II, T1 / T2
Nominal voltage $U_N$	60 V AC (TN)
Mode of protection	L-N / L-PEN / (L+) - (L-) / (L-) - PE / (L+) - PE
Maximum continuous operating voltage $U_C$	75 V AC / 100 V DC
Impulse discharge current $I_{imp}$ (10/350) $\mu$ s	12.5 kA
Nominal discharge current $I_n$ (8/20) $\mu$ s	12.5 kA
Max. discharge current $I_{max}$ (8/20) $\mu$ s	30 kA
Protection level $U_p$	$\leq 0.4$ kV
Response time $t_A$	$\leq 25$ ns
Short-circuit current rating $I_{SCCR}$	25 kA
Max. backup fuse with branch wiring	160 A (gG)
<b>General data</b>	
Dimensions W/H/D	17.5 mm / 97 mm / 77.5 mm
IEC connection data	Solid/stranded/AWG
UL connection data	AWG
Temperature range	-40 °C ... 80 °C
Test standards	IEC 61643-11 / EN 61643-11
<b>Remote indication contact</b>	
IEC connection data	Solid/stranded/AWG
UL connection data	AWG
Max. operating voltage	250 V AC / 125 V DC (200 mA DC)
Max. operating current	1.5 A AC / 1 A DC (30 V DC)

#### Ordering data

Description		
<b>VALVETRAB-MS</b> , varistor-based lightning current arrester		
with remote indication contact		
without remote indication contact		

Type	Order No.	Pcs./Pkt.
VAL-MS-T1/T2 48/12.5/1+0-FM	2801240	1
VAL-MS-T1/T2 48/12.5/1+0	2801241	1

#### Accessories

Replacement plug	L-N / L-PEN
------------------	-------------

VAL-MS-T1/T2 48/12.5 ST	2801242	10
-------------------------	---------	----



3-conductor system;  
L, N, PE

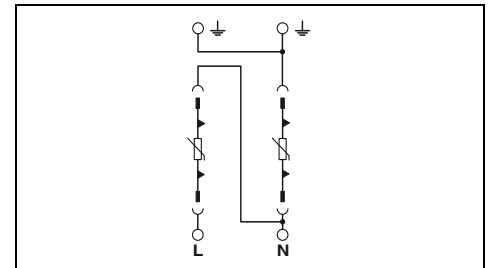

#### Technical data

<b>Electrical data</b>	
IEC test classification	I / II, T1 / T2
Nominal voltage $U_N$	60 V AC (TN-S)
Mode of protection	L-N / N-PE / (L+) - (L-) / (L+) - PE
Maximum continuous operating voltage $U_C$	75 V AC / 100 V DC
Impulse discharge current $I_{imp}$ (10/350) $\mu$ s	12.5 kA
Nominal discharge current $I_n$ (8/20) $\mu$ s	12.5 kA
Max. discharge current $I_{max}$ (8/20) $\mu$ s	30 kA
Protection level $U_p$	$\leq 0.4$ kV
Response time $t_A$	$\leq 25$ ns
Short-circuit current rating $I_{SCCR}$	25 kA
Max. backup fuse with branch wiring	160 A (gG)
<b>General data</b>	
Dimensions W/H/D	35.6 mm / 97 mm / 77.5 mm
IEC connection data	Solid/stranded/AWG
UL connection data	AWG
Temperature range	-40 °C ... 80 °C
Test standards	IEC 61643-11 / EN 61643-11
<b>Remote indication contact</b>	
IEC connection data	Solid/stranded/AWG
UL connection data	AWG
Max. operating voltage	250 V AC / 125 V DC (200 mA DC)
Max. operating current	1.5 A AC / 1 A DC (30 V DC)

#### Ordering data

Type	Order No.	Pcs./Pkt.
VAL-MS-T1/T2 48/12.5/1+1V-FM	2801533	1
VAL-MS-T1/T2 48/12.5/1+1V	2801532	1

#### Accessories

VAL-MS-T1/T2 48/12.5 ST	2801242	10
-------------------------	---------	----

### Type 1/2 combination protective device VALVETRAB MS

- Universal pluggability
- Suitable for 19" applications with rackmount systems
- Thermal disconnect device for each individual connector
- Optical, mechanical status indication for the individual arresters
- With or without floating remote indication contact
- Mechanical coding of all slots
- Plugs can be checked with CHECKMASTER



2-conductor system;  
L, PEN

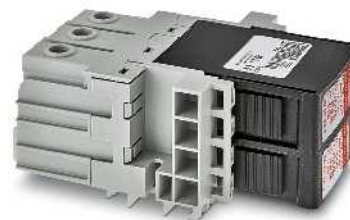

3-conductor system;  
L, N, PE

#### Notes:

If only one value is specified under mode of protection in the technical data, this value is valid for all modes of protection specified.

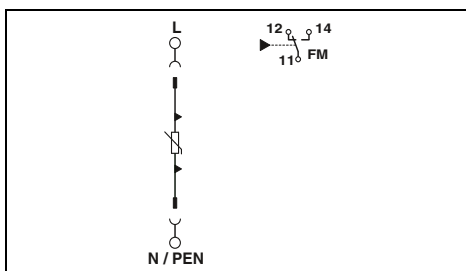

#### Technical data

Electrical data	
IEC test classification	I / II, T1 / T2
Nominal voltage $U_N$	- / -48 V DC
Mode of protection	L-PEN / (L+) - (L-) / (L-) - PE / (L+) - PE
Maximum continuous operating voltage $U_C$	75 V AC / 100 V DC
Impulse discharge current $I_{imp}$ (10/350) $\mu$ s	12.5 kA 12.5 kA
Nominal discharge current $I_n$ (8/20) $\mu$ s	12.5 kA
Max. discharge current $I_{max}$ (8/20) $\mu$ s	30 kA
Protection level $U_p$	$\leq 0.4$ kV
Response time $t_A$	$\leq 25$ ns
Short-circuit current rating $I_{SCCR}$	25 kA
Max. backup fuse with branch wiring	160 A AC (gG)

General data	
Dimensions W/H/D	17.5 mm / 77.1 mm / 89.2 mm
IEC connection data	Solid/stranded/AWG
UL connection data	AWG
Temperature range	-40 °C ... 80 °C
Test standards	EN 61643-11/A11
Remote indication contact	PDT contact
IEC connection data	Solid/stranded/AWG
UL connection data	AWG
Max. operating voltage	250 V AC / 125 V DC (200 mA DC)
Max. operating current	1.5 A / 1 A (30 V DC)

#### Ordering data

Description	Type	Order No.	Pcs./Pkt.
<b>VALVETRAB MS</b>			
with remote indication contact	VAL-MS-T1/T2 48/12.5/O-FM	2906282	12
without remote indication contact	VAL-MS-T1/T2 48/12.5/O	2906281	12

#### Accessories

Replacement plug		Order No.	
VALVETRAB, base element	L-N / L-PEN	2801242	10
		2905652	12
		2905650	12

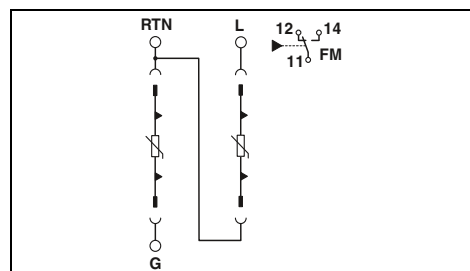

#### Technical data

Electrical data	
IEC test classification	I / II, T1 / T2
Nominal voltage $U_N$	60 V AC (TN-S) / -48 V DC
Mode of protection	L-N / N-PE / (L+) - (L-) / (L+) - PE
Maximum continuous operating voltage $U_C$	75 V AC / 100 V DC
Impulse discharge current $I_{imp}$ (10/350) $\mu$ s	12.5 kA
Nominal discharge current $I_n$ (8/20) $\mu$ s	12.5 kA
Max. discharge current $I_{max}$ (8/20) $\mu$ s	30 kA
Protection level $U_p$	$\leq 0.4$ kV
Response time $t_A$	$\leq 25$ ns
Short-circuit current rating $I_{SCCR}$	25 kA
Max. backup fuse with branch wiring	160 A AC (gG)

General data	
Dimensions W/H/D	70.6 mm / 40.6 mm / 98.1 mm
IEC connection data	- mm <sup>2</sup> / - mm <sup>2</sup> / 15 ... 2
UL connection data	10 ... 2
Temperature range	-40 °C ... 80 °C
Test standards	-
Remote indication contact	PDT contact
IEC connection data	- mm <sup>2</sup> / - mm <sup>2</sup> / 24 ... 20
UL connection data	-
Max. operating voltage	250 V AC / 125 V DC (200 mA DC)
Max. operating current	1.5 A / 1 A (30 V DC)

#### Ordering data

Description	Type	Order No.	Pcs./Pkt.
<b>VALVETRAB MS</b>			
with remote indication contact	VAL-MS-T1/T2 48/12.5/1+1/1U/FM	2909629	1

#### Accessories

Replacement plug		Order No.	
VALVETRAB, base element	L-N / L-PEN	2801242	10
		2909628	1

# Surge protection and interference suppression filters

## Surge protection for the power supply

### Type 1/2 combination protective device POWERTRAB PWT

- Series connection from the high-capacity varistor and gas-filled surge arrester
- Free of leakage current, suitable for use in the pre-meter area
- High TOV resistance for use in IT systems and in the event of repetitive current peaks, e.g., triggered by frequency inverters
- Satisfies the installation requirements for use in wind turbine generators according to CLC/TS 50539-22
- Encapsulated die-cast housing for direct assembly on mounting plates
- Suitable for use in harsh industrial environments
- High lightning impulse current of 35 kA per position
- Multi-stage status monitoring via remote indication contact
- Visual status indicator on the device

#### Notes:

If only one value is specified under mode of protection in the technical data, this value is valid for all modes of protection specified.



2-conductor system,  
L, PE/PEN



4-conductor system;  
L1, L2, L3, PE/PEN

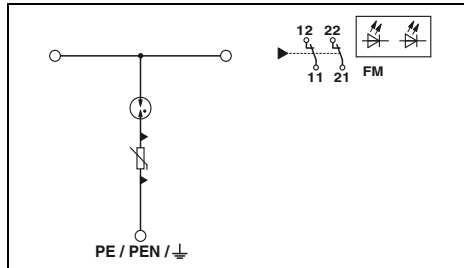

#### Technical data

I / II, T1 / T2  
690 V AC /  
554/960 V AC (TN-C) /  
690 V AC (IT)  
L-PE  
800 V AC  
35 kA  
35 kA  
100 kA  
≤ 2.2 kV  
≤ 4.5 kV  
≤ 100 ns  
50 kA  
400 A (gG; 2 x 50 mm<sup>2</sup>)

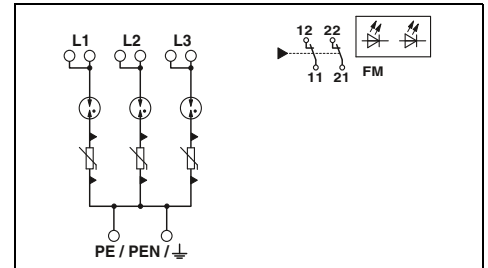

#### Technical data

I / II, T1 / T2  
690 V AC /  
554/960 V AC (TN-C) /  
690 V AC (IT)  
L-PE  
800 V AC  
35 kA  
35 kA  
100 kA  
≤ 2.2 kV  
≤ 4.5 kV  
≤ 100 ns  
50 kA  
400 A (gG; 2 x 50 mm<sup>2</sup>)

General data	
Dimensions W/H/D	56 mm / 191 mm / 280 mm
IEC connection data	Solid/stranded/AWG
UL connection data	AWG
Temperature range	-40 °C ... 80 °C
Test standards	IEC 61643-11 / EN 61643-11
Remote indication contact	2x N/C contacts, 1-pos.
IEC connection data	Solid/stranded/AWG
UL connection data	AWG
Max. operating voltage	30 V AC / 30 V DC
Max. operating current	1.5 A AC / 1.5 A DC

Dimensions W/H/D	176 mm / 191 mm / 280 mm
IEC connection data	16 ... 50 mm <sup>2</sup> / 16 ... 50 mm <sup>2</sup> / 6 ... 1/0
UL connection data	1/0 ... 6
Temperature range	-40 °C ... 80 °C
Test standards	IEC 61643-11 / EN 61643-11
Remote indication contact	2x N/C contacts, 1-pos.
IEC connection data	0.2 ... 2.5 mm <sup>2</sup> / 0.2 ... 2.5 mm <sup>2</sup> / 24 ... 12
UL connection data	24 ... 12
Max. operating voltage	30 V AC / 30 V DC
Max. operating current	1.5 A AC / 1.5 A DC

#### Ordering data

Description	Type	Order No.	Pcs./Pkt.
POWERTRAB	PWT 35-800AC-FM	2800419	1
POWERTRAB, incl. mounting set			

#### Ordering data

Description	Type	Order No.	Pcs./Pkt.
	PWT 100-800AC-FM	2800531	1

#### Accessories

Mounting set for connecting three lightning current arresters of type PWT 35-800AC-FM	PWT CCT-SET	2800532	1
Mounting set for connecting four lightning current arresters of type PWT 35-800AC-FM	PWT CCT-SET 4	2905613	1

#### Accessories

--	--	--	--

### Type 1/2 combination protective device VALVETRAB MB / VALVETRAB MS

- Double terminal block for safe and easy equipotential bonding connection
- Screw shafts with raised domes to ensure safe working
- Main connections with extended insertion funnels for increased resistance to creepage
- Optical, mechanical status indication for the individual arresters
- Visual display for checking the status directly on the device
- Pluggable signal connection for remote status signaling
- Compact design for space-saving installation

**Notes:**  
If only one value is specified under mode of protection in the technical data, this value is valid for all modes of protection specified.

new



One-piece lightning current and surge protection for PV applications up to 1500 V DC



Pluggable lightning current and surge protection for PV applications up to 1000 V DC

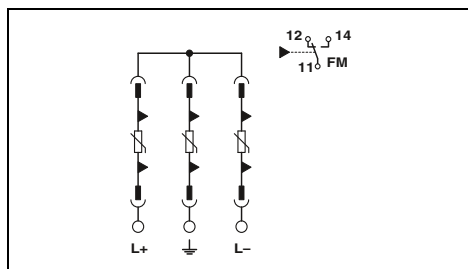
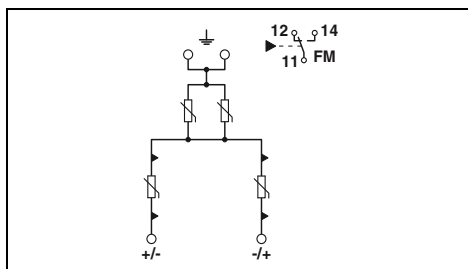

#### Technical data

Electrical data	... 600DC	... 1000DC	... 1500DC
IEC test classification	PV I / II, T1 / T2	PV I / II, T1 / T2	PV I / II, T1 / T2
Mode of protection	(L+) - (L-) / (L+) - PE / (L-) - PE	(L+) - (L-) / (L+) - PE / (L-) - PE	(L+) - (L-) / (L+) - PE / (L-) - PE
Maximum continuous operating voltage $U_{CPV}$	800 V DC	1000 V DC	1500 V DC
Impulse discharge current $I_{imp}$ (10/350) $\mu$ s	6.25 kA	6.25 kA	6.25 kA
Nominal discharge current $I_n$ (8/20) $\mu$ s	20 kA	20 kA	20 kA
Max. discharge current $I_{max}$ (8/20) $\mu$ s	40 kA	40 kA	40 kA
Protection level $U_p$	$\leq 2.9$ kV	$\leq 3.3$ kV	$\leq 4.5$ kV
Response time $t_A$	$\leq 25$ ns	$\leq 25$ ns	$\leq 25$ ns
Open circuit voltage $U_{OCSTC}$	$\leq 667$ V DC	$\leq 833$ V DC	$\leq 1250$ V DC
Short-circuit current rating $I_{SCPV}$	2000 A	2000 A	2000 A
General data			
Dimensions W/H/D		71.2 mm / 120 mm / 65.5 mm	
IEC connection data	Solid/stranded/AWG	- mm <sup>2</sup> / 2.5 ... 35 mm <sup>2</sup> / 14 ... 2	
Temperature range		-40 °C ... 80 °C	
Test standards		EN 50539-11	
Remote indication contact		PDT contact	
IEC connection data	Solid/stranded/AWG	0.14 ... 1.5 mm <sup>2</sup> / 0.14 ... 1.5 mm <sup>2</sup> / 28 ... 16	
Max. operating voltage		250 V AC / 5 V DC ... 30 V DC	
Max. operating current		1.5 A AC / 5 mA DC ... 1 A DC	

#### Ordering data

Description	Type	Order No.	Pcs./Pkt.
VALVETRAB ...PV	VAL-MB-T1/T2 600DC-PV/2+V-FM	2906292	1
	VAL-MB-T1/T2 1000DC-PV/2+V-FM	2905638	1
	VAL-MB-T1/T2 1500DC-PV/2+V-FM	2905640	1
VALVETRAB ...PV, without FM contact	VAL-MB-T1/T2 600DC-PV/2+V	2906293	1
	VAL-MB-T1/T2 1000DC-PV/2+V	2905639	1
	VAL-MB-T1/T2 1500DC-PV/2+V	2905641	1

#### Accessories

Replacement plug	
600 V DC	(L+)-PE & (L)-PE & (L+)-(L-)
1000 V DC	(L+)-PE & (L)-PE & (L+)-(L-)

#### Technical data

Electrical data	... 600DC	... 1000DC
IEC test classification	PV I / II, T1 / T2	PV I / II, T1 / T2
Mode of protection	(L+) - (L-) / (L+) - PE / (L-) - PE	(L+) - (L-) / (L+) - PE / (L-) - PE
Maximum continuous operating voltage $U_{CPV}$	720 V DC	1050 V DC
Impulse discharge current $I_{imp}$ (10/350) $\mu$ s	5 kA	5 kA
Nominal discharge current $I_n$ (8/20) $\mu$ s	15 kA	15 kA
Max. discharge current $I_{max}$ (8/20) $\mu$ s	40 kA	40 kA
Protection level $U_p$	$\leq 2.6$ kV	$\leq 3.5$ kV
Response time $t_A$	$\leq 25$ ns	$\leq 25$ ns
Open circuit voltage $U_{OCSTC}$	$\leq 600$ V DC	$\leq 875$ V DC
Short-circuit current rating $I_{SCPV}$	1000 A	1000 A
General data		
Dimensions W/H/D		53.4 mm / 99 mm / 65.5 mm
IEC connection data		1.5 ... 35 mm <sup>2</sup> / 1.5 ... 25 mm <sup>2</sup> / 15 ... 2
Temperature range		-40 °C ... 80 °C
Test standards		EN 50539-11
Remote indication contact		PDT contact
IEC connection data		0.14 ... 1.5 mm <sup>2</sup> / 0.14 ... 1.5 mm <sup>2</sup> / 28 ... 16
Max. operating voltage		250 V AC / 30 V DC
Max. operating current		1.5 A AC / 1 A DC

#### Ordering data

Description	Type	Order No.	Pcs./Pkt.
VALVETRAB ...PV	VAL-MS-T1/T2 600DC-PV/2+V-FM	2801164	1
	VAL-MS-T1/T2 1000DC-PV/2+V-FM	2801161	1
VALVETRAB ...PV, without FM contact	VAL-MS-T1/T2 600DC-PV/2+V	2801163	1
	VAL-MS-T1/T2 1000DC-PV/2+V	2801160	1

#### Accessories

Replacement plug	
600 V DC	(L+)-PE & (L)-PE & (L+)-(L-)
1000 V DC	(L+)-PE & (L)-PE & (L+)-(L-)

# Surge protection and interference suppression filters

## Surge protection for the power supply

### Type 1+2 protective device combination FLASHTRAB SEC T1+T2

- Directly coordinated combination of type 1 spark gap without line follow current and type 2 varistor arrester
- Particularly suitable for maximum protection of sensitive devices in harsh environments
- Pluggable
- High continuous voltage of 350 V AC for 230/400 V AC networks with high voltage fluctuations
- Low voltage protection level of 1.5 kV
- Optical, mechanical status indicator
- With floating remote indication contact
- Plugs can be checked with CHECKMASTER

**Notes:**  
If only one value is specified under mode of protection in the technical data, this value is valid for all modes of protection specified.



5-conductor system;  
L1, L2, L3, N, PE

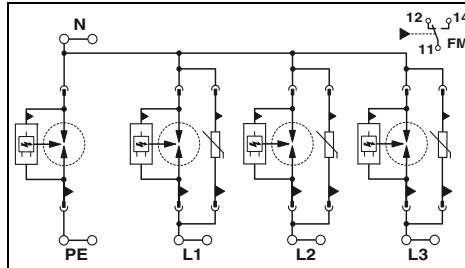

4-conductor system;  
L1, L2, L3, PEN

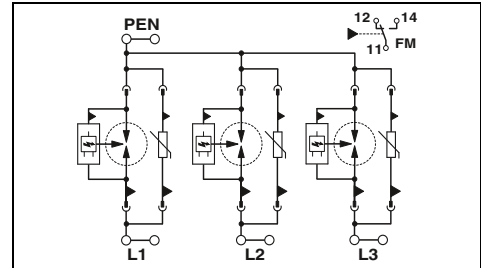

**Electrical data**  
IEC test classification  
Nominal voltage  $U_N$

**Mode of protection**  
Maximum continuous operating voltage  $U_C$   
Impulse discharge current  $I_{imp}$  (10/350)  $\mu$ s  
Nominal discharge current  $I_n$  (8/20)  $\mu$ s  
Protection level  $U_p$   
Follow current interrupt rating  $I_{fi}$   
Response time  $t_A$   
Short-circuit current rating  $I_{SCCR}$   
Max. backup fuse with branch wiring

#### Technical data

I + II, T1 + T2  
240/415 V AC (TN-S) /  
240/415 V AC (TT)  
L-N / L-PE / N-PE  
350 V AC  
25 kA / 25 kA / 100 kA  
25 kA / 25 kA / 100 kA  
 $\leq 1.5$  kV /  $\leq 2.2$  kV /  $\leq 1.5$  kV  
25 kA (264 V AC) / - / 100 A (350 V AC)  
 $\leq 25$  ns / - /  $\leq 100$  ns  
25 kA (264 V AC)  
315 A (gG)

**General data**  
Dimensions W/H/D  
IEC connection data  
UL connection data  
Temperature range  
Test standards  
Remote indication contact  
IEC connection data  
UL connection data  
Max. operating voltage  
Max. operating current

142.4 mm / 95.2 mm / 74.5 mm  
2.5 ... 35 mm<sup>2</sup> / 2.5 ... 35 mm<sup>2</sup> / 13 ... 2  
12 ... 2  
-40 °C ... 80 °C  
IEC 61643-11 / EN 61643-11  
PDT contact  
0.14 ... 1.5 mm<sup>2</sup> / 0.14 ... 1.5 mm<sup>2</sup> / 28 ... 16  
30 ... 14  
250 V AC / 125 V DC (200 mA DC)  
1 A AC / 1 A DC (30 V DC)

**Description**  
Type 1+2 protective device combination

#### Ordering data

Type	Order No.	Pcs./Pkt.
FLT-SEC-T1+T2-3S-350/25-FM	2905470	1

**Replacement plug**  
L-N / L-PEN  
L-N / L-PEN  
N-PE

#### Accessories

Accessories	Order No.	1
FLT-SEC-T1-350/25-P	2905471	1
VAL-SEC-T2-350-P	2905346	1
FLT-SEC-P-T1-N/PE-350/100-P	2905473	1

#### Technical data

I + II, T1 + T2  
240/415 V AC (TN-C)  
L-PEN  
350 V AC  
25 kA  
25 kA  
 $\leq 1.5$  kV  
25 kA (264 V AC)  
 $\leq 25$  ns  
25 kA (264 V AC)  
315 A (gG)

106.8 mm / 95.2 mm / 74.5 mm  
2.5 ... 35 mm<sup>2</sup> / 2.5 ... 35 mm<sup>2</sup> / 13 ... 2  
12 ... 2  
-40 °C ... 80 °C  
IEC 61643-11 / EN 61643-11  
PDT contact  
0.14 ... 1.5 mm<sup>2</sup> / 0.14 ... 1.5 mm<sup>2</sup> / 28 ... 16  
30 ... 14  
250 V AC / 125 V DC (200 mA DC)  
1 A AC / 1 A DC (30 V DC)

#### Ordering data

Type	Order No.	Pcs./Pkt.
FLT-SEC-T1+T2-3C-350/25-FM	2905469	1

#### Accessories

Accessories	Order No.	1
FLT-SEC-T1-350/25-P	2905471	1
VAL-SEC-T2-350-P	2905346	1



4-conductor system;  
L1, L2, N, PE



3-conductor system;  
L1, L2, PEN



3-conductor system;  
L, N, PE

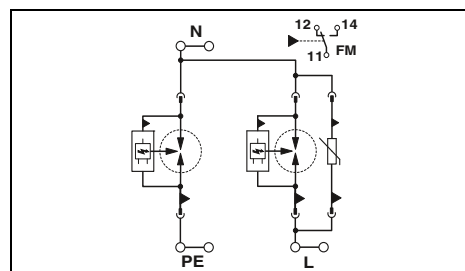
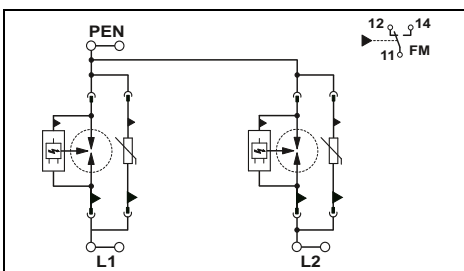
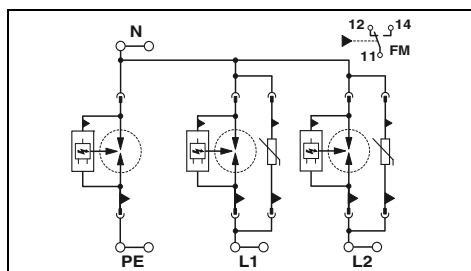

### Technical data

I + II, T1 + T2  
240/415 V AC (TN-S) /  
240/415 V AC (TT)  
L-N / L-PE / N-PE  
350 V AC  
25 kA / 25 kA / 100 kA  
25 kA / 25 kA / 100 kA  
≤ 1.5 kV / ≤ 2.2 kV / ≤ 1.5 kV  
25 kA (264 V AC) / - / 100 A (350 V AC)  
≤ 25 ns / - / ≤ 100 ns  
25 kA (264 V AC)  
315 A (gG)

### Technical data

I + II, T1 + T2  
240/415 V AC (TN-C)  
L-PEN  
350 V AC  
25 kA  
25 kA  
≤ 1.5 kV  
25 kA (264 V AC)  
≤ 25 ns  
25 kA (264 V AC)  
315 A (gG)

### Technical data

I + II, T1 + T2  
240 V AC (TN-S) /  
240 V AC (TT)  
L-N / L-PE / N-PE  
350 V AC  
25 kA / 25 kA / 100 kA  
25 kA / 25 kA / 100 kA  
≤ 1.5 kV / ≤ 2.2 kV / ≤ 1.5 kV  
25 kA (264 V AC) / - / 100 A (350 V AC)  
≤ 25 ns / - / ≤ 100 ns  
25 kA (264 V AC)  
315 A (gG)

106.8 mm / 95.2 mm / 74.5 mm  
2.5 ... 35 mm<sup>2</sup> / 2.5 ... 35 mm<sup>2</sup> / 13 ... 2  
12 ... 2  
-40 °C ... 80 °C  
IEC 61643-11 / EN 61643-11  
PDT contact  
0.14 ... 1.5 mm<sup>2</sup> / 0.14 ... 1.5 mm<sup>2</sup> / 28 ... 16  
30 ... 14  
250 V AC / 125 V DC (200 mA DC)  
1 A AC / 1 A DC (30 V DC)

71.2 mm / 95.2 mm / 74.5 mm  
2.5 ... 35 mm<sup>2</sup> / 2.5 ... 35 mm<sup>2</sup> / 13 ... 2  
12 ... 2  
-40 °C ... 80 °C  
IEC 61643-11 / EN 61643-11  
PDT contact  
0.14 ... 1.5 mm<sup>2</sup> / 0.14 ... 1.5 mm<sup>2</sup> / 28 ... 16  
30 ... 14  
250 V AC / 125 V DC (200 mA DC)  
1 A AC / 1 A DC (30 V DC)

71.2 mm / 95.2 mm / 74.5 mm  
2.5 ... 35 mm<sup>2</sup> / 2.5 ... 35 mm<sup>2</sup> / 13 ... 2  
12 ... 2  
-40 °C ... 80 °C  
IEC 61643-11 / EN 61643-11  
PDT contact  
0.14 ... 1.5 mm<sup>2</sup> / 0.14 ... 1.5 mm<sup>2</sup> / 28 ... 16  
30 ... 14  
250 V AC / 125 V DC (200 mA DC)  
1 A AC / 1 A DC (30 V DC)

### Ordering data

Type	Order No.	Pcs./Pkt.
FLT-SEC-T1+T2-2S-350/25-FM	2905468	1

### Ordering data

Type	Order No.	Pcs./Pkt.
FLT-SEC-T1+T2-2C-350/25-FM	2905467	1

### Ordering data

Type	Order No.	Pcs./Pkt.
FLT-SEC-T1+T2-1S-350/25-FM	2905466	1

### Accessories

FLT-SEC-T1-350/25-P	2905471	1
VAL-SEC-T2-350-P	2905346	1
FLT-SEC-P-T1-N/PE-350/100-P	2905473	1

### Accessories

FLT-SEC-T1-350/25-P	2905471	1
VAL-SEC-T2-350-P	2905346	1

### Accessories

FLT-SEC-T1-350/25-P	2905471	1
VAL-SEC-T2-350-P	2905346	1
FLT-SEC-P-T1-N/PE-350/100-P	2905473	1

# Surge protection and interference suppression filters

## Surge protection for the power supply

### Type 1+2 protective device combination FLASHTRAB SEC T1+T2

- Directly coordinated combination of type 1 spark gap without line follow current and type 2 varistor arrester
- Particularly suitable for maximum protection of sensitive devices in harsh environments
- Pluggable
- High continuous voltage of 350 V AC for 230/400 V AC networks with high voltage fluctuations
- Low voltage protection level of 1.5 kV
- Optical, mechanical status indicator
- With floating remote indication contact
- Plugs can be checked with CHECKMASTER

**Notes:**  
If only one value is specified under mode of protection in the technical data, this value is valid for all modes of protection specified.



2-conductor system;  
L, PEN

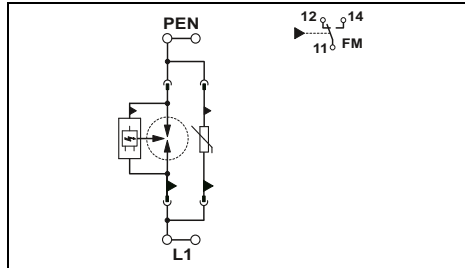

#### Technical data

I + II, T1 + T2  
240 V AC (TN-C) /  
240 V AC (TT)  
L-PEN  
350 V AC  
25 kA  
25 kA  
≤ 1.5 kV  
25 kA (264 V AC)  
≤ 25 ns  
25 kA (264 V AC)  
315 A (gG)



N-PE spark gap

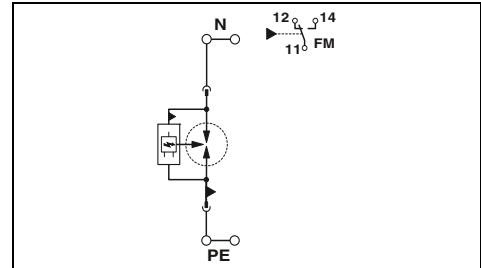

#### Technical data

I / II, T1 / T2  
240 V AC (TN - only N-PE) /  
240 V AC (TT - only N-PE)  
N-PE  
350 V AC  
100 kA  
100 kA  
≤ 1.5 kV  
100 A  
≤ 100 ns  
-

<b>Electrical data</b>	
IEC test classification	
Nominal voltage $U_N$	
<b>Mode of protection</b>	
Maximum continuous operating voltage $U_C$	
Impulse discharge current $I_{imp}$ (10/350) $\mu$ s	
Nominal discharge current $I_n$ (8/20) $\mu$ s	
Protection level $U_p$	
Follow current interrupt rating $I_{fi}$	
Response time $t_A$	
Short-circuit current rating $I_{SCCR}$	
Max. backup fuse with branch wiring	
<b>General data</b>	
Dimensions W/H/D	
IEC connection data	Solid/stranded/AWG
UL connection data	AWG
Temperature range	
Test standards	
<b>Remote indication contact</b>	
IEC connection data	Solid/stranded/AWG
UL connection data	AWG
Max. operating voltage	
Max. operating current	

Dimensions W/H/D	35.6 mm / 95.2 mm / 74.5 mm
IEC connection data	2.5 ... 35 mm <sup>2</sup> / 2.5 ... 35 mm <sup>2</sup> / 13 ... 2
UL connection data	12 ... 2
Temperature range	-40 °C ... 80 °C
Test standards	IEC 61643-11 / EN 61643-11
<b>Remote indication contact</b>	
IEC connection data	0.14 ... 1.5 mm <sup>2</sup> / 0.14 ... 1.5 mm <sup>2</sup> / 28 ... 16
UL connection data	30 ... 14
Max. operating voltage	250 V AC / 125 V DC (200 mA DC)
Max. operating current	1 A AC / 1 A DC (30 V DC)

Dimensions W/H/D	35.6 mm / 95.2 mm / 74.5 mm
IEC connection data	2.5 ... 35 mm <sup>2</sup> / 2.5 ... 35 mm <sup>2</sup> / 13 ... 2
UL connection data	12 ... 2
Temperature range	-40 °C ... 80 °C
Test standards	IEC 61643-11 / EN 61643-11
<b>Remote indication contact</b>	
IEC connection data	0.14 ... 1.5 mm <sup>2</sup> / 0.14 ... 1.5 mm <sup>2</sup> / 28 ... 16
UL connection data	30 ... 14
Max. operating voltage	250 V AC / 125 V DC (200 mA DC)
Max. operating current	1 A AC / 1 A DC (30 V DC)

<b>Ordering data</b>	
Description	
<b>Type 1+2 protective device combination</b>	

Type	Order No.	Pcs./Pkt.
FLT-SEC-T1+T2-1C-350/25-FM	2905465	1

Type	Order No.	Pcs./Pkt.
FLT-SEC-P-T1-N/PE-350/100-FM	2905472	1

<b>Accessories</b>	
Replacement plug	
L-N / L-PEN	
L-N / L-PEN	
N-PE	

Accessories	Order No.	Pcs./Pkt.
FLT-SEC-T1-350/25-P	2905471	1
VAL-SEC-T2-350-P	2905346	1

Accessories	Order No.	Pcs./Pkt.
FLT-SEC-P-T1-N/PE-350/100-P	2905473	1

### Type 2 surge protective device VALVETRAB SEC

- Varistor arrester with a low leakage current
- High-performance gas-filled surge arrester for N/PE protection
- Version with high nominal discharge current of 40 kA in the N-PE path for systems with increased safety requirements
- Extremely narrow design, just 12 mm per position, including for 400/690 V AC systems
- Pluggable
- Low voltage protection level of 1.5 kV for 230/400 V AC systems or 1.9 kV for 400/690 V AC systems
- Optical, mechanical status indicator
- With floating remote indication contact as an option
- Plugs can be checked with CHECKMASTER

**Notes:**  
If only one value is specified under mode of protection in the technical data, this value is valid for all modes of protection specified.



5-conductor system;  
L1, L2, L3, N, PE

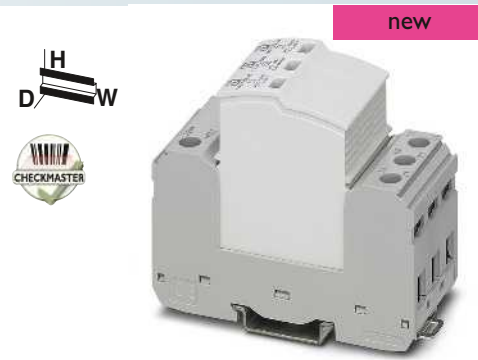

4-conductor system,  
L1, L2, L3, PE(N)

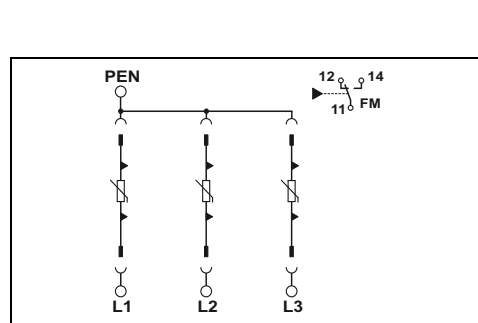
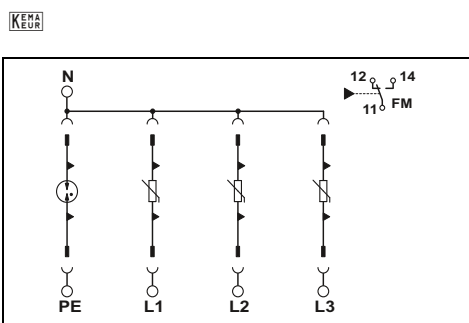

#### Electrical data

IEC test classification  
Nominal voltage  $U_N$   
  
Mode of protection  
Maximum continuous operating voltage  $U_c$   
Nominal discharge current  $I_n$  (8/20)  $\mu$ s  
Max. discharge current  $I_{max}$  (8/20)  $\mu$ s  
Protection level  $U_p$   
Response time  $t_A$   
Short-circuit current rating  $I_{SCCR}$   
  
Max. backup fuse with branch wiring

#### Technical data

II, T2  
240/415 V AC (TN-S) /  
240/415 V AC (TT)  
L-N / L-PE / N-PE  
350 V AC / 350 V AC / 264 V AC  
20 kA / 20 kA / 40 kA  
40 kA / 40 kA / 80 kA  
 $\leq 1.5$  kV /  $\leq 1.9$  kV /  $\leq 1.5$  kV  
 $\leq 25$  ns /  $\leq 100$  ns /  $\leq 100$  ns  
25 kA (in case of 315 A gG backup fuse) /  
50 kA (in case of 200 A gG backup fuse)  
315 A (gG)

#### Technical data

II, T2  
400/690 V AC (TN-C)  
  
L-PEN  
440 V AC  
20 kA  
40 kA  
 $\leq 1.9$  kV  
 $\leq 25$  ns  
25 kA (in case of 315 A gG backup fuse) /  
50 kA (in case of 200 A gG backup fuse)  
315 A (gG)

#### General data

Dimensions W/H/D  
IEC connection data  
Temperature range  
Test standards  
Remote indication contact  
IEC connection data  
Max. operating voltage  
Max. operating current

49.2 mm / 97.9 mm / 74.5 mm  
2.5 ... 25 mm<sup>2</sup> / 2.5 ... 16 mm<sup>2</sup> / 12 ... 4  
-40 °C ... 80 °C  
IEC 61643-11 / EN 61643-11  
PDT contact  
0.14 ... 1.5 mm<sup>2</sup> / 0.14 ... 1.5 mm<sup>2</sup> / 28 ... 16  
250 V AC / 125 V DC (200 mA DC)  
1 A AC / 1 A DC (30 V DC)

37.3 mm / 97.9 mm / 74.5 mm  
2.5 ... 25 mm<sup>2</sup> / 2.5 ... 16 mm<sup>2</sup> / 12 ... 4  
-40 °C ... 80 °C  
IEC 61643-11 / EN 61643-11  
PDT contact  
0.14 ... 1.5 mm<sup>2</sup> / 0.14 ... 1.5 mm<sup>2</sup> / 28 ... 16  
250 V AC / 125 V DC (200 mA DC)  
1 A AC / 1 A DC (30 V DC)

#### Description

**VALVETRAB SEC**  
with remote indication contact  
without remote indication contact

#### Ordering data

Type	Order No.	Pcs./Pkt.
VAL-SEC-T2-3S-350/40-FM	2909635	1
VAL-SEC-T2-3S-350/40	2909637	1

#### Ordering data

Type	Order No.	Pcs./Pkt.
VAL-SEC-T2-3C-440-FM	2909968	1

#### Replacement plug

L-N / L-PEN  
N-PE

#### Accessories

VAL-SEC-T2-350-P	2905346	1
VAL-SEC-T2-N/PE-264/40-P	2909636	1

#### Accessories

VAL-SEC-T2-440-P	2909969	1
------------------	---------	---

# Surge protection and interference suppression filters

## Surge protection for the power supply

### Type 2 surge protective device VALVETRAB SEC 350

- Varistor arrester with a low leakage current
- High-performance gas-filled surge arrester for N/PE protection
- Extremely narrow design, just 12 mm per position
- Pluggable
- High continuous voltage of 350 V AC for 230/400 V AC networks with high voltage fluctuations
- Low voltage protection level of 1.5 kV
- VF versions free of leakage current with series connection from the varistor and gas-filled surge arrester
- Optical, mechanical status indicator
- With floating remote indication contact as an option
- Plugs can be checked with CHECKMASTER

**Notes:**  
If only one value is specified under mode of protection in the technical data, this value is valid for all modes of protection specified.



5-conductor system;  
L1, L2, L3, N, PE

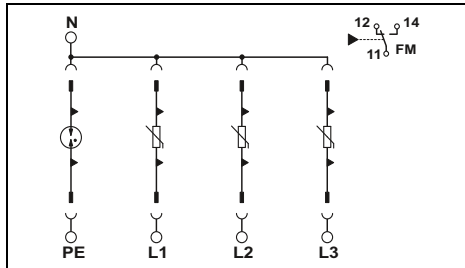

Technical data	
... 350	... 350VF
II, T2	II, T2
240/415 V AC (TN-S) / 240/415 V AC (TT)	240/415 V AC (TN-S) / 240/415 V AC (TT)
L-N / L-PE / N-PE	L-N / L-PE / N-PE
350 V AC / 350 V AC / 264 V AC	350 V AC / 350 V AC / 264 V AC
20 kA	10 kA / 10 kA / 20 kA
40 kA	20 kA / 20 kA / 40 kA
≤ 1.5 kV / ≤ 1.9 kV / ≤ 1.5 kV	≤ 1.5 kV / ≤ 2.3 kV / ≤ 1.5 kV
≤ 25 ns / ≤ 100 ns / ≤ 100 ns	≤ 100 ns
25 kA (in case of 315 A gG backup fuse) / 50 kA (in case of 200 A gG backup fuse)	50 kA
Max. backup fuse with branch wiring	315 A (gG)                      200 A (gG)
General data	
Dimensions W/H/D	49.2 mm / 97.9 mm / 74.5 mm
IEC connection data	2.5 ... 25 mm <sup>2</sup> / 2.5 ... 16 mm <sup>2</sup> / 12 ... 4
UL connection data	14 ... 2 (solid)
Temperature range	-40 °C ... 80 °C
Test standards	IEC 61643-11 / EN 61643-11
Remote indication contact	PDT contact
IEC connection data	0.14 ... 1.5 mm <sup>2</sup> / 0.14 ... 1.5 mm <sup>2</sup> / 28 ... 16
UL connection data	30 ... 14
Max. operating voltage	250 V AC / 125 V DC (200 mA DC)
Max. operating current	1 A AC / 1 A DC (30 V DC)

Ordering data			
Type	Order No.	Pcs./Pkt.	
VAL-SEC-T2-3S-350-FM	2905340	1	
VAL-SEC-T2-3S-350	2905345	1	
VAL-SEC-T2-3S-350VF-FM	2909590	1	

Accessories			
Type	Order No.	Pcs./Pkt.	
VAL-SEC-T2-350-P	2905346	1	
VAL-SEC-T2-N/PE-350-P	2905347	1	
VAL-SEC-T2-350VF-P	2909596	1	

Electrical data	
IEC test classification	
Nominal voltage U <sub>N</sub>	
Mode of protection	
Maximum continuous operating voltage U <sub>C</sub>	
Nominal discharge current I <sub>n</sub> (8/20) μs	
Max. discharge current I <sub>max</sub> (8/20) μs	
Protection level U <sub>p</sub>	
Response time tA	
Short-circuit current rating I <sub>SCCR</sub>	
General data	
Dimensions W/H/D	
IEC connection data	Solid/stranded/AWG
UL connection data	AWG
Temperature range	
Test standards	
Remote indication contact	
IEC connection data	Solid/stranded/AWG
UL connection data	AWG
Max. operating voltage	
Max. operating current	

Description	Type	Order No.	Pcs./Pkt.
VALVETRAB SEC			
with remote indication contact			
without remote indication contact			
VALVETRAB SEC...VF, free of leakage current			
with remote indication contact			

Replacement plug	Type	Order No.	Pcs./Pkt.
	L-N / L-PEN		
	N-PE		
Free of leakage current	L-N / L-PEN		



4-conductor system;  
L1, L2, L3, PEN

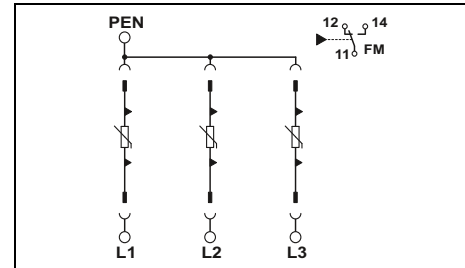

Technical data	
... 350	... 350VF
II, T2	II, T2
240/415 V AC (TN-C)	240/415 V AC (TN-C)
L-PEN	L-PEN
350 V AC	350 V AC
20 kA	10 kA
40 kA	20 kA
≤ 1.5 kV	≤ 1.5 kV
≤ 25 ns	≤ 100 ns
25 kA (in case of 315 A gG backup fuse) / 50 kA (in case of 200 A gG backup fuse)	50 kA
Max. backup fuse with branch wiring	315 A (gG)                      200 A (gG)
General data	
Dimensions W/H/D	37.3 mm / 97.9 mm / 74.5 mm
IEC connection data	2.5 ... 25 mm <sup>2</sup> / 2.5 ... 16 mm <sup>2</sup> / 12 ... 4
UL connection data	14 ... 2 (solid)
Temperature range	-40 °C ... 80 °C
Test standards	IEC 61643-11 / EN 61643-11
Remote indication contact	PDT contact
IEC connection data	0.14 ... 1.5 mm <sup>2</sup> / 0.14 ... 1.5 mm <sup>2</sup> / 28 ... 16
UL connection data	30 ... 14
Max. operating voltage	250 V AC / 125 V DC (200 mA DC)
Max. operating current	1 A AC / 1 A DC (30 V DC)

Ordering data			
Type	Order No.	Pcs./Pkt.	
VAL-SEC-T2-3C-350-FM	2905339	1	
VAL-SEC-T2-3C-350	2905344	1	
VAL-SEC-T2-3C-350VF-FM	2909591	1	

Accessories			
Type	Order No.	Pcs./Pkt.	
VAL-SEC-T2-350-P	2905346	1	
VAL-SEC-T2-350VF-P	2909596	1	

new



4-conductor system;  
L1, L2, N, PE



3-conductor system;  
L1, L2, PEN



3-conductor system; L, N, PE

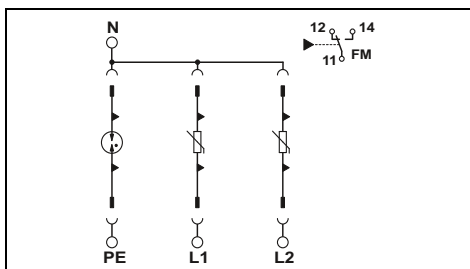

### Technical data

... 350  
II, T2  
240/415 V AC (TN-S) /  
240/415 V AC (TT)  
L-N / L-PE / N-PE  
350 V AC / 350 V AC / 264 V AC  
20 kA  
40 kA  
≤ 1.5 kV / ≤ 1.9 kV / ≤ 1.5 kV  
≤ 25 ns / ≤ 100 ns / ≤ 100 ns  
25 kA (in case of 315 A gG backup fuse) /  
50 kA (in case of 200 A gG backup fuse)

315 A (gG)

37.3 mm / 97.9 mm / 74.5 mm  
2.5 ... 25 mm<sup>2</sup> / 2.5 ... 16 mm<sup>2</sup> / 12 ... 4  
14 ... 2 (solid)  
-40 °C ... 80 °C  
IEC 61643-11 / EN 61643-11  
PDT contact  
0.14 ... 1.5 mm<sup>2</sup> / 0.14 ... 1.5 mm<sup>2</sup> / 28 ... 16  
30 ... 14  
250 V AC / 125 V DC (200 mA DC)  
1 A AC / 1 A DC (30 V DC)

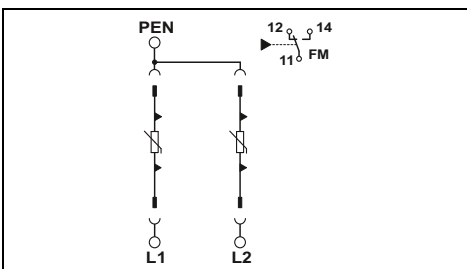

### Technical data

... 350  
II, T2  
240/415 V AC (TN-C)  
L-PEN  
350 V AC  
20 kA  
40 kA  
≤ 1.5 kV  
≤ 25 ns  
25 kA (in case of 315 A gG backup fuse) /  
50 kA (in case of 200 A gG backup fuse)

315 A (gG)

25.4 mm / 97.9 mm / 74.5 mm  
2.5 ... 25 mm<sup>2</sup> / 2.5 ... 16 mm<sup>2</sup> / 12 ... 4  
14 ... 2 (solid)  
-40 °C ... 80 °C  
IEC 61643-11 / EN 61643-11  
PDT contact  
0.14 ... 1.5 mm<sup>2</sup> / 0.14 ... 1.5 mm<sup>2</sup> / 28 ... 16  
30 ... 14  
250 V AC / 125 V DC (200 mA DC)  
1 A AC / 1 A DC (30 V DC)

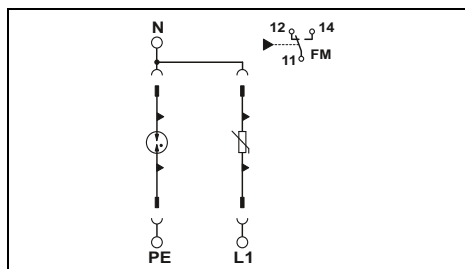

### Technical data

... 350	... 350VF
II, T2	II, T2
240 V AC (TN-S) / 240 V AC (TT)	240 V AC (TN-S) / 240 V AC (TT)
L-N / L-PE / N-PE	L-N / L-PE / N-PE
350 V AC / 350 V AC / 264 V AC	350 V AC / 350 V AC / 264 V AC
20 kA	10 kA / 10 kA / 20 kA
40 kA	20 kA / 20 kA / 40 kA
≤ 1.5 kV / ≤ 1.9 kV / ≤ 1.5 kV	≤ 1.5 kV / ≤ 2.3 kV / ≤ 1.5 kV
≤ 25 ns / ≤ 100 ns / ≤ 100 ns	≤ 100 ns
25 kA (in case of 315 A gG backup fuse) / 50 kA (in case of 200 A gG backup fuse)	50 kA
315 A (gG)	200 A (gG)

25.4 mm / 97.9 mm / 74.5 mm  
2.5 ... 25 mm<sup>2</sup> / 2.5 ... 16 mm<sup>2</sup> / 12 ... 4  
14 ... 2 (solid)  
-40 °C ... 80 °C  
IEC 61643-11 / EN 61643-11  
PDT contact  
0.14 ... 1.5 mm<sup>2</sup> / 0.14 ... 1.5 mm<sup>2</sup> / 28 ... 16  
30 ... 14  
250 V AC / 125 V DC (200 mA DC)  
1 A AC / 1 A DC (30 V DC)

### Ordering data

Type	Order No.	Pcs./Pkt.
VAL-SEC-T2-2S-350-FM	2905338	1
VAL-SEC-T2-2S-350	2905343	1

### Accessories

VAL-SEC-T2-350-P	2905346	1
VAL-SEC-T2-N/PE-350-P	2905347	1

### Ordering data

Type	Order No.	Pcs./Pkt.
VAL-SEC-T2-2C-350-FM	2905337	1
VAL-SEC-T2-2C-350	2905342	1

### Accessories

VAL-SEC-T2-350-P	2905346	1
------------------	---------	---

### Ordering data

Type	Order No.	Pcs./Pkt.
VAL-SEC-T2-1S-350-FM	2905333	1
VAL-SEC-T2-1S-350	2905341	1
VAL-SEC-T2-1S-350VF-FM	2909592	1

### Accessories

VAL-SEC-T2-350-P	2905346	1
VAL-SEC-T2-N/PE-350-P	2905347	1
VAL-SEC-T2-350VF-P	2909596	1

# Surge protection and interference suppression filters

## Surge protection for the power supply

### Type 2 surge protective device VALVETRAB SEC 175

- Varistor arrester with a low leakage current
- High-performance gas-filled surge arrester for N/PE protection
- Extremely narrow design, just 12 mm per position
- Pluggable
- High continuous voltage of 175 V AC for 120/208 V AC networks with high voltage fluctuations
- Low voltage protection level of 0.85 kV for the L-N mode of protection and 0.95 kV for the N-PE mode of protection
- Optical, mechanical status indicator
- Plugs can be checked with CHECKMASTER

**Notes:**  
If only one value is specified under mode of protection in the technical data, this value is valid for all modes of protection specified.



5-conductor system;  
L1, L2, L3, N, PE

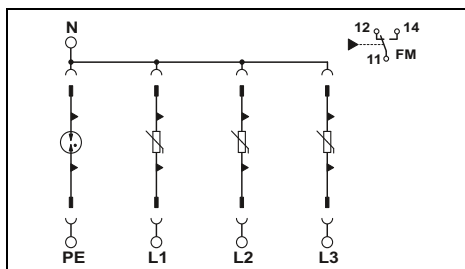

4-conductor system;  
L1, L2, L3, PEN

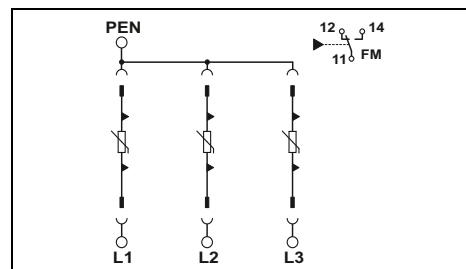

Electrical data	
IEC test classification	... 175
Nominal voltage $U_N$	II, T2 120/208 V AC (TN-S) / 120/208 V AC (TT)
Mode of protection	L-N / L-PE / N-PE
Maximum continuous operating voltage $U_C$	175 V AC / 175 V AC / 150 V AC
Nominal discharge current $I_n$ (8/20) $\mu$ s	20 kA
Max. discharge current $I_{max}$ (8/20) $\mu$ s	40 kA
Protection level $U_p$	$\leq 0.85$ kV / $\leq 1.3$ kV / $\leq 0.95$ kV
Response time $t_A$	$\leq 25$ ns / $\leq 100$ ns / $\leq 100$ ns
Short-circuit current rating $I_{SCCR}$	25 kA (in case of 315 A gG backup fuse) / 50 kA (in case of 200 A gG backup fuse)
Max. backup fuse with branch wiring	315 A (gG)
General data	
Dimensions W/H/D	49.2 mm / 97.9 mm / 74.5 mm
IEC connection data	2.5 ... 25 mm <sup>2</sup> / 2.5 ... 16 mm <sup>2</sup> / 12 ... 4
UL connection data	14 ... 2 (solid)
Temperature range	-40 °C ... 80 °C
Test standards	IEC 61643-11 / EN 61643-11
Remote indication contact	
IEC connection data	PDT contact
UL connection data	0.14 ... 1.5 mm <sup>2</sup> / 0.14 ... 1.5 mm <sup>2</sup> / 28 ... 16
Max. operating voltage	30 ... 14
Max. operating current	250 V AC / 125 V DC (200 mA DC) 1 A AC / 1 A DC (30 V DC)

Technical data		
... 175	II, T2	120/208 V AC (TN-S) / 120/208 V AC (TT)
L-N / L-PE / N-PE	175 V AC / 175 V AC / 150 V AC	20 kA
	40 kA	$\leq 0.85$ kV / $\leq 1.3$ kV / $\leq 0.95$ kV
	$\leq 25$ ns / $\leq 100$ ns / $\leq 100$ ns	25 kA (in case of 315 A gG backup fuse) / 50 kA (in case of 200 A gG backup fuse)
	315 A (gG)	
General data		
Dimensions W/H/D	49.2 mm / 97.9 mm / 74.5 mm	
IEC connection data	2.5 ... 25 mm <sup>2</sup> / 2.5 ... 16 mm <sup>2</sup> / 12 ... 4	
UL connection data	14 ... 2 (solid)	
Temperature range	-40 °C ... 80 °C	
Test standards	IEC 61643-11 / EN 61643-11	
Remote indication contact		
IEC connection data	PDT contact	
UL connection data	0.14 ... 1.5 mm <sup>2</sup> / 0.14 ... 1.5 mm <sup>2</sup> / 28 ... 16	
Max. operating voltage	30 ... 14	
Max. operating current	250 V AC / 125 V DC (200 mA DC) 1 A AC / 1 A DC (30 V DC)	

Technical data		
... 175	II, T2	120/208 V AC (TN-C)
L-PEN	175 V AC	20 kA
	40 kA	$\leq 0.85$ kV
	$\leq 25$ ns	25 kA (in case of 315 A gG backup fuse) / 50 kA (in case of 200 A gG backup fuse)
	315 A (gG)	
General data		
Dimensions W/H/D	37.3 mm / 97.9 mm / 74.5 mm	
IEC connection data	2.5 ... 25 mm <sup>2</sup> / 2.5 ... 16 mm <sup>2</sup> / 12 ... 4	
UL connection data	14 ... 2 (solid)	
Temperature range	-40 °C ... 80 °C	
Test standards	IEC 61643-11 / EN 61643-11	
Remote indication contact		
IEC connection data	PDT contact	
UL connection data	0.14 ... 1.5 mm <sup>2</sup> / 0.14 ... 1.5 mm <sup>2</sup> / 28 ... 16	
Max. operating voltage	30 ... 14	
Max. operating current	250 V AC / 125 V DC (200 mA DC) 1 A AC / 1 A DC (30 V DC)	

Ordering data	
Type	Order No. Pcs./Pkt.
VALVETRAB SEC with remote indication contact	VAL-SEC-T2-3S-175-FM 2905354 1

Ordering data		
Type	Order No.	Pcs./Pkt.
VAL-SEC-T2-3S-175-FM	2905354	1

Accessories	
Replacement plug	L-N / L-PEN N-PE
VAL-SEC-T2-175-P	2905355 1
VAL-SEC-T2-N/PE-175-P	2905356 1

Accessories		
Replacement plug	L-N / L-PEN N-PE	
VAL-SEC-T2-175-P	2905355	1
VAL-SEC-T2-N/PE-175-P	2905356	1

Ordering data	
Type	Order No. Pcs./Pkt.
VALVETRAB SEC with remote indication contact	VAL-SEC-T2-3C-175-FM 2905353 1

Accessories		
Replacement plug	L-N / L-PEN N-PE	
VAL-SEC-T2-175-P	2905355	1



4-conductor system;  
L1, L2, N, PE



3-conductor system;  
L1, L2, PEN



3-conductor system;  
L, N, PE

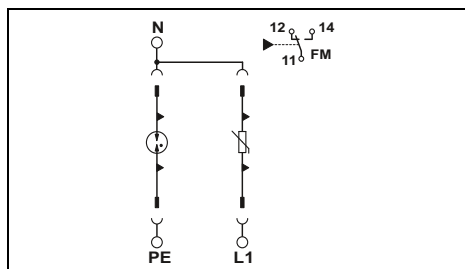
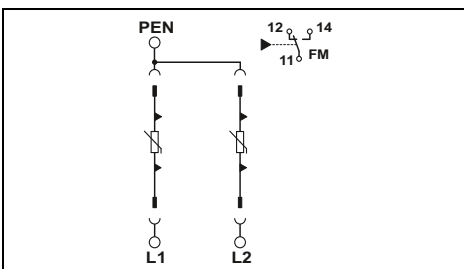
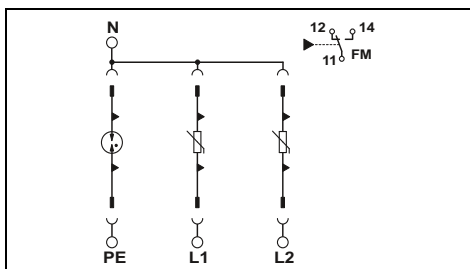

### Technical data

### Technical data

### Technical data

... 175  
II, T2  
120/208 V AC (TN-S) /  
120/208 V AC (TT)  
L-N / L-PE / N-PE  
175 V AC / 175 V AC / 150 V AC  
20 kA  
40 kA  
≤ 0.85 kV / ≤ 1.3 kV / ≤ 0.95 kV  
≤ 25 ns / ≤ 100 ns / ≤ 100 ns  
25 kA (in case of 315 A gG backup fuse) /  
50 kA (in case of 200 A gG backup fuse)  
315 A (gG)

... 175  
II, T2  
120/208 V AC (TN-C)  
L-PEN  
175 V AC  
20 kA  
40 kA  
≤ 0.85 kV  
≤ 25 ns  
25 kA (in case of 315 A gG backup fuse) /  
50 kA (in case of 200 A gG backup fuse)  
315 A (gG)

... 175  
II, T2  
120 V AC (TN-S) /  
120 V AC (TT)  
L-N / L-PE / N-PE  
175 V AC / 175 V AC / 150 V AC  
20 kA  
40 kA  
≤ 0.85 kV / ≤ 1.3 kV / ≤ 0.95 kV  
≤ 25 ns / - / ≤ 100 ns  
25 kA (in case of 315 A gG backup fuse) /  
50 kA (in case of 200 A gG backup fuse)  
315 A (gG)

37.3 mm / 97.9 mm / 74.5 mm  
2.5 ... 25 mm<sup>2</sup> / 2.5 ... 16 mm<sup>2</sup> / 12 ... 4  
14 ... 2 (solid)  
-40 °C ... 80 °C  
IEC 61643-11 / EN 61643-11  
PDT contact  
0.14 ... 1.5 mm<sup>2</sup> / 0.14 ... 1.5 mm<sup>2</sup> / 28 ... 16  
30 ... 14  
250 V AC / 125 V DC (200 mA DC)  
1 A AC / 1 A DC (30 V DC)

25.4 mm / 97.9 mm / 74.5 mm  
2.5 ... 25 mm<sup>2</sup> / 2.5 ... 16 mm<sup>2</sup> / 12 ... 4  
14 ... 2 (solid)  
-40 °C ... 80 °C  
IEC 61643-11 / EN 61643-11  
PDT contact  
0.14 ... 1.5 mm<sup>2</sup> / 0.14 ... 1.5 mm<sup>2</sup> / 28 ... 16  
30 ... 14  
250 V AC / 125 V DC (200 mA DC)  
1 A AC / 1 A DC (30 V DC)

25.4 mm / 97.9 mm / 74.5 mm  
2.5 ... 25 mm<sup>2</sup> / 2.5 ... 16 mm<sup>2</sup> / 12 ... 4  
14 ... 2 (solid)  
-40 °C ... 80 °C  
IEC 61643-11 / EN 61643-11  
PDT contact  
0.14 ... 1.5 mm<sup>2</sup> / 0.14 ... 1.5 mm<sup>2</sup> / 28 ... 16  
30 ... 14  
250 V AC / 125 V DC (200 mA DC)  
1 A AC / 1 A DC (30 V DC)

### Ordering data

### Ordering data

### Ordering data

Type	Order No.	Pcs./Pkt.
VAL-SEC-T2-2S-175-FM	2905351	1

Type	Order No.	Pcs./Pkt.
VAL-SEC-T2-2C-175-FM	2905350	1

Type	Order No.	Pcs./Pkt.
VAL-SEC-T2-1S-175-FM	2905348	1

### Accessories

### Accessories

### Accessories

VAL-SEC-T2-175-P	2905355	1
VAL-SEC-T2-N/PE-175-P	2905356	1

VAL-SEC-T2-175-P	2905355	1
------------------	---------	---

VAL-SEC-T2-175-P	2905355	1
VAL-SEC-T2-N/PE-175-P	2905356	1

# Surge protection and interference suppression filters

## Surge protection for the power supply

### Type 2 surge protective device VALVETRAB SEC DC

- Varistor arrester with a low leakage current
- Extremely narrow design, just 12 mm per position
- High continuous voltage for linear DC current sources with voltage fluctuations
- Pluggable
- Low protection level
- Optical, mechanical status indicator
- With floating remote indication contact
- Plugs can be checked with CHECKMASTER

#### Notes:

If only one value is specified under mode of protection in the technical data, this value is valid for all modes of protection specified.

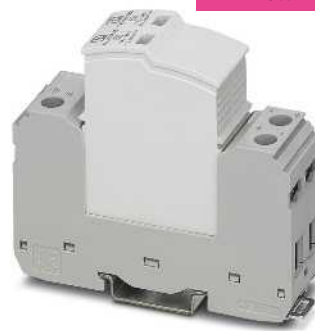

3-conductor system, DC+, DC-, PE  
for 48 V DC



3-conductor system, DC+, DC-, PE  
for 120 V DC

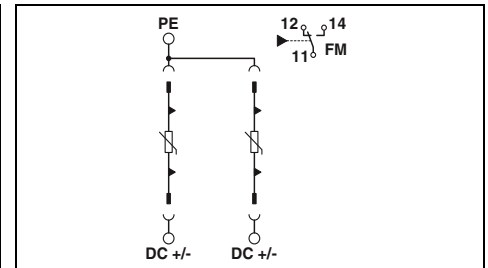
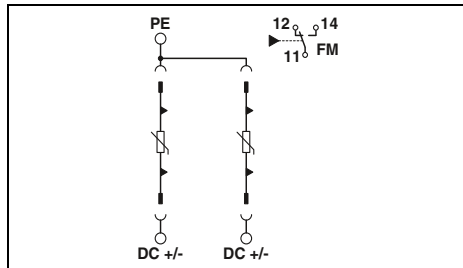

#### Technical data

Electrical data	
IEC test classification	II, T2
Nominal voltage $U_N$	48 V DC ... 60 V DC
Mode of protection	(DC+) - (DC-) / (DC+/DC-) - PE
Maximum continuous operating voltage $U_C$	75 V DC
Nominal discharge current $I_n$ (8/20) $\mu$ s	20 kA
Max. discharge current $I_{max}$ (8/20) $\mu$ s	40 kA
Protection level $U_p$	$\leq 0.9$ kV / $\leq 0.5$ kV
Response time $t_A$	$\leq 25$ ns
Short-circuit current rating $I_{SCCR}$	0.2 kA (without backup fuse) / 6 kA (for 20 A gG/B backup fuse)
Max. backup fuse with branch wiring	20 A (gG / B at $I_{SCCR} > 200$ A)

Technical data	
IEC test classification	II, T2
Nominal voltage $U_N$	100 V DC ... 120 V DC
Mode of protection	(DC+) - (DC-) / (DC+/DC-) - PE
Maximum continuous operating voltage $U_C$	150 V DC
Nominal discharge current $I_n$ (8/20) $\mu$ s	20 kA
Max. discharge current $I_{max}$ (8/20) $\mu$ s	40 kA
Protection level $U_p$	$\leq 1.8$ kV / $\leq 0.85$ kV
Response time $t_A$	$\leq 25$ ns
Short-circuit current rating $I_{SCCR}$	0.2 kA (without backup fuse) / 6 kA (for 20 A gG/B backup fuse)
Max. backup fuse with branch wiring	20 A (gG / B at $I_{SCCR} > 200$ A)

#### Technical data

General data	
Dimensions W/H/D	25.4 mm / 97.9 mm / 74.5 mm
IEC connection data	Solid/stranded/AWG
Temperature range	2.5 ... 25 mm <sup>2</sup> / 2.5 ... 16 mm <sup>2</sup> / 12 ... 4
Test standards	-40 °C ... 80 °C
Remote indication contact	IEC 61643-11 / EN 61643-11
IEC connection data	PDT contact
Max. operating voltage	0.14 ... 1.5 mm <sup>2</sup> / 0.14 ... 1.5 mm <sup>2</sup> / 28 ... 16
Max. operating current	250 V AC / 125 V DC (200 mA DC)

General data	
Dimensions W/H/D	25.4 mm / 97.9 mm / 74.5 mm
IEC connection data	Solid/stranded/AWG
Temperature range	2.5 ... 25 mm <sup>2</sup> / 2.5 ... 16 mm <sup>2</sup> / 12 ... 4
Test standards	-40 °C ... 80 °C
Remote indication contact	IEC 61643-11 / EN 61643-11
IEC connection data	PDT contact
Max. operating voltage	0.14 ... 1.5 mm <sup>2</sup> / 0.14 ... 1.5 mm <sup>2</sup> / 28 ... 16
Max. operating current	250 V AC / 125 V DC (200 mA DC)

General data	
Dimensions W/H/D	25.4 mm / 97.9 mm / 74.5 mm
IEC connection data	Solid/stranded/AWG
Temperature range	2.5 ... 25 mm <sup>2</sup> / 2.5 ... 16 mm <sup>2</sup> / 12 ... 4
Test standards	-40 °C ... 80 °C
Remote indication contact	IEC 61643-11 / EN 61643-11
IEC connection data	PDT contact
Max. operating voltage	0.14 ... 1.5 mm <sup>2</sup> / 0.14 ... 1.5 mm <sup>2</sup> / 28 ... 16
Max. operating current	250 V AC / 125 V DC (200 mA DC)

#### Ordering data

Description	
VALVETRAB SEC	

Type	Order No.	Pcs./Pkt.
VAL-SEC-T2-2+0-48DC-FM	2907865	1

#### Ordering data

Type	Order No.	Pcs./Pkt.
VAL-SEC-T2-2+0-120DC-FM	2907874	1

#### Accessories

Replacement plug	(DC+/DC-) - PE
------------------	----------------

Type	Order No.	Pcs./Pkt.
VAL-SEC-T2-48DC-P	2907877	1

#### Accessories

Type	Order No.	Pcs./Pkt.
VAL-SEC-T2-120DC-P	2907878	1

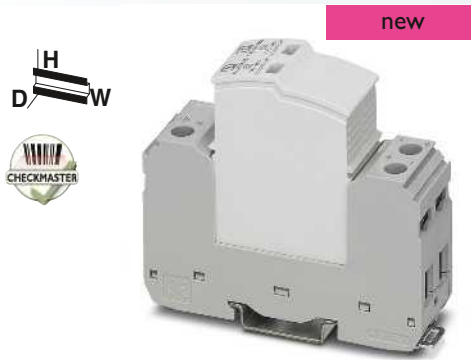

**3-conductor system, DC+, DC-, PE  
for 220 V DC**

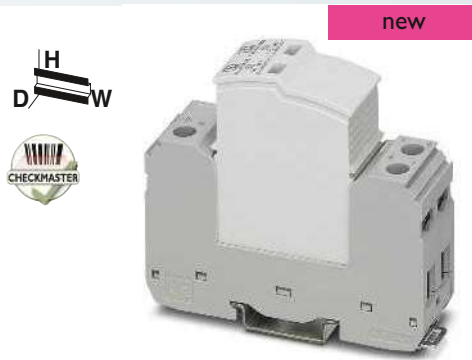

**3-conductor system, DC+, DC-, PE  
for 380 V DC**

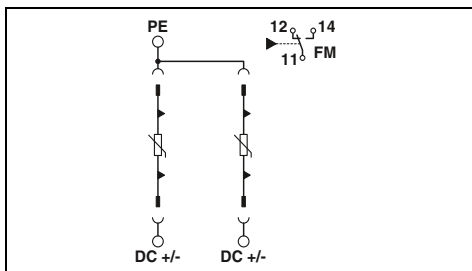
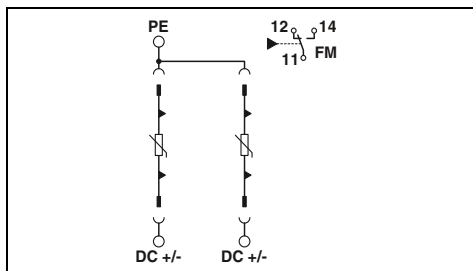

### Technical data

II, T2  
200 V DC ... 220 V DC  
(DC+) - (DC-) / (DC+/DC-) - PE  
250 V DC  
20 kA  
40 kA  
≤ 3 kV / ≤ 1.5 kV  
≤ 25 ns  
0.2 kA (without backup fuse) /  
6 kA (for 20 A gG/B backup fuse)  
20 A (gG / B at I<sub>SCCR</sub> > 200 A)

25.4 mm / 97.9 mm / 74.5 mm  
2.5 ... 25 mm<sup>2</sup> / 2.5 ... 16 mm<sup>2</sup> / 12 ... 4  
-40 °C ... 80 °C  
IEC 61643-11 / EN 61643-11  
PDT contact  
0.14 ... 1.5 mm<sup>2</sup> / 0.14 ... 1.5 mm<sup>2</sup> / 28 ... 16  
250 V AC / 125 V DC (200 mA DC)  
1 A AC / 1 A DC (30 V DC)

### Ordering data

Type	Order No.	Pcs./Pkt.
VAL-SEC-T2-2+0-220DC-FM	2907875	1

### Accessories

VAL-SEC-T2-220DC-P	2907879	1
--------------------	---------	---

### Technical data

II, T2  
350 V DC ... 400 V DC  
(DC+) - (DC-) / (DC+/DC-) - PE  
450 V DC  
20 kA  
40 kA  
≤ 3 kV / ≤ 1.5 kV  
≤ 25 ns  
0.1 kA (without backup fuse) /  
6 kA (for 20 A gG/B backup fuse)  
20 A (gG / B at I<sub>SCCR</sub> > 200 A)

25.4 mm / 97.9 mm / 74.5 mm  
2.5 ... 25 mm<sup>2</sup> / 2.5 ... 16 mm<sup>2</sup> / 12 ... 4  
-40 °C ... 80 °C  
IEC 61643-11 / EN 61643-11  
PDT contact  
0.14 ... 1.5 mm<sup>2</sup> / 0.14 ... 1.5 mm<sup>2</sup> / 28 ... 16  
250 V AC / 125 V DC (200 mA DC)  
1 A AC / 1 A DC (30 V DC)

### Ordering data

Type	Order No.	Pcs./Pkt.
VAL-SEC-T2-2+0-380DC-FM	2907876	1

### Accessories

VAL-SEC-T2-380DC-P	2907880	1
--------------------	---------	---

# Surge protection and interference suppression filters

## Surge protection for the power supply

### Type 2 surge protective device VALVETRAB MS 230 / 320

- Multi-channel type 2 arrester
- Consistently pluggable type 2 surge protective device
- Disconnect device on each individual connector
- Optical, mechanical status indication for the individual arresters
- With or without floating remote indication contact
- Mechanical coding of all slots
- Plugs can be checked with CHECKMASTER



5-conductor system; L1, L2, L3, N, PE,  
supply line supply from below



5-conductor system; L1, L2, L3, N, PE,  
supply line supply from above

**Notes:**  
If only one value is specified under mode of protection in the technical data, this value is valid for all modes of protection specified.

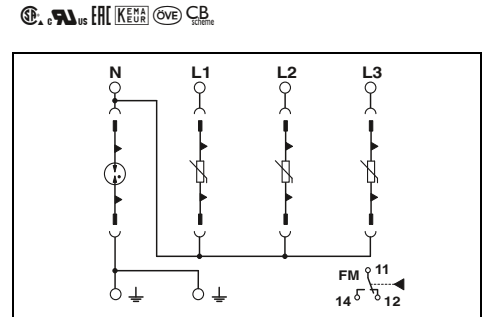
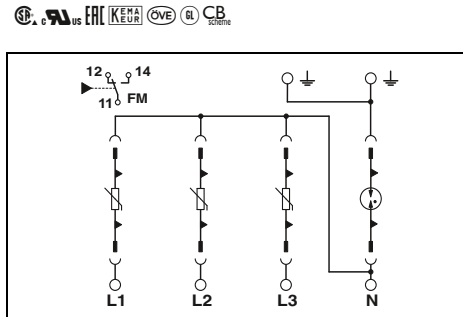

Electrical data	
IEC test classification	II, T2
Nominal voltage $U_N$	240/415 V AC (TN-S) / 240/415 V AC (TT)
Mode of protection	L-N / L-PE / N-PE
Maximum continuous operating voltage $U_C$	275 V AC / 275 V AC / 260 V AC
Nominal discharge current $I_n$ (8/20) $\mu$ s	20 kA
Max. discharge current $I_{max}$ (8/20) $\mu$ s	40 kA
Protection level $U_p$	$\leq 1.35$ kV / $\leq 1.6$ kV / $\leq 1.5$ kV
Follow current interrupt rating $I_{fi}$	- / - / 100 A
Response time $t_A$	$\leq 25$ ns / $\leq 100$ ns / $\leq 100$ ns
Short-circuit current rating $I_{SCCR}$	25 kA
Max. backup fuse with branch wiring	125 A (gG)

Technical data	
VAL-MS 230	VAL-MS 320
II, T2	II, T2
240/415 V AC (TN-S) / 240/415 V AC (TT)	240/415 V AC (TN-S) / 240/415 V AC (TT)
L-N / L-PE / N-PE	L-N / L-PE / N-PE
275 V AC / 275 V AC / 260 V AC	335 V AC / 335 V AC / 260 V AC
20 kA	20 kA
40 kA	40 kA
$\leq 1.35$ kV / $\leq 1.6$ kV / $\leq 1.5$ kV	$\leq 1.6$ kV / $\leq 1.9$ kV / $\leq 1.5$ kV
- / - / 100 A	- / - / 100 A
$\leq 25$ ns / $\leq 100$ ns / $\leq 100$ ns	$\leq 25$ ns / $\leq 100$ ns / $\leq 100$ ns
25 kA	25 kA
125 A (gG)	125 A (gG)

Technical data	
VAL-MS 320	VAL-MS 320
II, T2	II, T2
240/415 V AC (TN-S) / 240/415 V AC (TT)	240/415 V AC (TN-S) / 240/415 V AC (TT)
L-N / L-PE / N-PE	L-N / L-PE / N-PE
335 V AC / 335 V AC / 260 V AC	335 V AC / 335 V AC / 260 V AC
20 kA	20 kA
40 kA	40 kA
$\leq 1.6$ kV / $\leq 1.9$ kV / $\leq 1.5$ kV	$\leq 1.6$ kV / $\leq 1.9$ kV / $\leq 1.5$ kV
- / - / 100 A	- / - / 100 A
$\leq 25$ ns / $\leq 100$ ns / $\leq 100$ ns	$\leq 25$ ns / $\leq 100$ ns / $\leq 100$ ns
25 kA	25 kA
125 A (gG)	125 A (gG)

General data	
Dimensions W/H/D	71 mm / 99 mm / 65.5 mm
IEC connection data	1.5 ... 35 mm <sup>2</sup> / 1.5 ... 25 mm <sup>2</sup> / 15 ... 2
UL connection data	10 ... 2 AWG
Temperature range	-40 °C ... 80 °C
Test standards	IEC 61643-11 / EN 61643-11
Remote indication contact	PDT contact
IEC connection data	0.14 ... 1.5 mm <sup>2</sup> / 0.14 ... 1.5 mm <sup>2</sup> / 28 ... 16
UL connection data	30 ... 14 AWG
Max. operating voltage	250 V AC / 30 V DC
Max. operating current	750 mA AC / 1 A DC

Ordering data			
Type	Order No.	Pcs./Pkt.	
VAL-MS 230/3+1	2838209	1	
VAL-MS 230/3+1 FM	2838199	1	
VAL-MS 320/3+1	2859178	1	
VAL-MS 320/3+1/FM	2859181	1	

Ordering data			
Type	Order No.	Pcs./Pkt.	
VAL-MS 320/3+1/FM-UD	2856689	1	

Replacement plug	
1L-N/PE	VAL-MS 230 ST
1L-N/PE	VAL-MS 320 ST
N-PE	F-MS 12 ST

Accessories			
VAL-MS 230 ST	2798844	10	
VAL-MS 320 ST	2838843	10	
F-MS 12 ST	2817990	10	

Accessories			
VAL-MS 320-UD ST	2858315	10	
F-MS 12 ST	2817990	10	



**4-conductor system;  
L1, L2, L3, PEN**



**3-conductor system;  
L, N, PE**

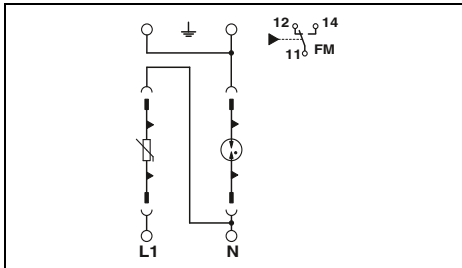
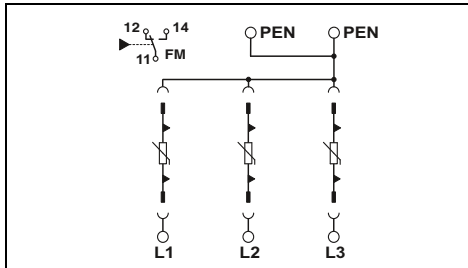

### Technical data

VAL-MS 320  
II, T2  
240/415 V AC (TN-C)  
  
L-PEN  
335 V AC  
20 kA  
40 kA  
≤ 1.5 kV  
-  
≤ 25 ns  
25 kA  
125 A (gG)

### Technical data

VAL-MS 230	VAL-MS 320
II, T2	II, T2
240/415 V AC (TN-S) / 240/415 V AC (TT)	240/415 V AC (TN-S) / 240/415 V AC (TT)
L-N / L-PE / N-PE	L-N / L-PE / N-PE
275 V AC / - / 260 V AC	335 V AC / - / 260 V AC
20 kA	20 kA
40 kA	40 kA
≤ 1.35 kV / ≤ 1.6 kV / ≤ 1.5 kV	≤ 1.5 kV / ≤ 1.8 kV / ≤ 1.5 kV
- / - / 100 A	- / - / 100 A
≤ 25 ns / ≤ 100 ns / ≤ 100 ns	≤ 25 ns / ≤ 100 ns / ≤ 100 ns
25 kA	25 kA
125 A (gG)	125 A (gG)

53.4 mm / 99 mm / 65.5 mm  
1.5 ... 35 mm<sup>2</sup> / 1.5 ... 25 mm<sup>2</sup> / 15 ... 2

-40 °C ... 80 °C  
IEC 61643-11 / EN 61643-11

PDT contact  
0.14 ... 1.5 mm<sup>2</sup> / 0.14 ... 1.5 mm<sup>2</sup> / 28 ... 16  
30 ... 14

250 V AC / 30 V DC  
1.5 A AC / 1 A DC

35.6 mm / 97 mm / 65.5 mm  
1.5 ... 35 mm<sup>2</sup> / 1.5 ... 25 mm<sup>2</sup> / 15 ... 2

-40 °C ... 80 °C  
IEC 61643-11 / EN 61643-11

PDT contact  
0.14 ... 1.5 mm<sup>2</sup> / 0.14 ... 1.5 mm<sup>2</sup> / 28 ... 16  
30 ... 14

250 V AC / 30 V DC  
1.5 A AC / 1 A DC

### Ordering data

Type	Order No.	Pcs./Pkt.
VAL-MS 320/3+0	2920230	1
VAL-MS 320/3+0-FM	2920243	1

### Ordering data

Type	Order No.	Pcs./Pkt.
VAL-MS 230/1+1	2804429	1
VAL-MS 230/1+1-FM	2804432	1
VAL-MS 320/1+1	2804380	1
VAL-MS 320/1+1-FM	2804393	1

### Accessories

VAL-MS 320 ST	2838843	10
---------------	---------	----

### Accessories

VAL-MS 230 ST	2798844	10
VAL-MS 320 ST	2838843	10
F-MS 12 ST	2817990	10

# Surge protection and interference suppression filters

## Surge protection for the power supply

### Type 2 surge protective device VALVETRAB MS 350

- DIN-rail-mountable protective devices
- Comprising base element and plug
- Free of leakage current
- Thermal disconnect device for each individual connector
- Optical, mechanical status indication for the individual arresters
- With or without floating remote indication contact
- Mechanical coding of all slots
- Plugs can be checked with CHECKMASTER



5-conductor system; L1, L2, L3, N, PE  
Free of leakage current



2-conductor system; L, N, PEN  
Free of leakage current

#### Notes:

If only one value is specified under mode of protection in the technical data, this value is valid for all modes of protection specified.

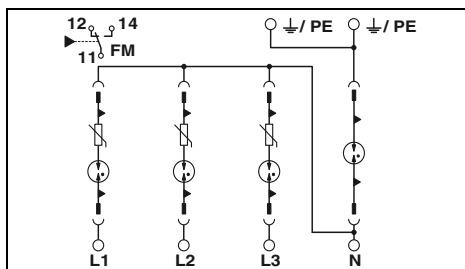

#### Technical data

II, T2  
240/415 V AC (TN-S) /  
240/415 V AC (TT)  
  
L-N / L-PE / N-PE  
350 V AC / 350 V AC / 260 V AC  
10 kA / 10 kA / 20 kA  
20 kA / 20 kA / 40 kA  
 $\leq 1.5 \text{ kV} / \leq 2 \text{ kV} / \leq 1.5 \text{ kV}$   
- / - / 100 A  
 $\leq 100 \text{ ns}$   
25 kA  
125 A (gG)

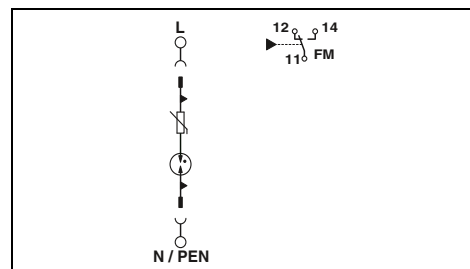

#### Technical data

II, T2  
240/415 V AC (TN) /  
240/415 V AC (TT) /  
230 V AC (IT)  
L-N / L-PE / L-PEN  
350 V AC  
10 kA  
20 kA  
 $\leq 1.5 \text{ kV}$   
- / - / -  
 $\leq 100 \text{ ns}$   
25 kA  
125 A (gG)

General data	
Dimensions W/H/D	71 mm / 99 mm / 65.5 mm
IEC connection data	Solid/stranded/AWG 1.5 ... 35 mm <sup>2</sup> / 1.5 ... 25 mm <sup>2</sup> / 15 ... 2
UL connection data	AWG 10 ... 2
Temperature range	-40 °C ... 80 °C
Test standards	IEC 61643-11 / EN 61643-11
Remote indication contact	
IEC connection data	Solid/stranded/AWG 0.14 ... 1.5 mm <sup>2</sup> / 0.14 ... 1.5 mm <sup>2</sup> / 28 ... 16
UL connection data	AWG 30 ... 14
Max. operating voltage	250 V AC / 30 V DC
Max. operating current	750 mA AC / 1 A DC

#### Ordering data

Type	Order No.	Pcs./Pkt.
VAL-MS 350VF/3+1-FM	2858632	1
VAL-MS 350 VF/3+1	2858755	1

#### Accessories

VAL-MS 350 VF ST	2856595	10
F-MS 12 ST	2817990	10

Description	
<b>VALVETRAB MS</b>	
with remote indication contact	
without remote indication contact	

Replacement plug	1L-N/PE N-PE
------------------	-----------------

General data	
Dimensions W/H/D	17.6 mm / 97 mm / 65.5 mm
IEC connection data	Solid/stranded/AWG 1.5 ... 35 mm <sup>2</sup> / 1.5 ... 25 mm <sup>2</sup> / 15 ... 2
UL connection data	AWG 10 ... 2
Temperature range	-40 °C ... 80 °C
Test standards	IEC 61643-11 / EN 61643-11
Remote indication contact	
IEC connection data	Solid/stranded/AWG 0.14 ... 1.5 mm <sup>2</sup> / 0.14 ... 1.5 mm <sup>2</sup> / 28 ... 16
UL connection data	AWG 30 ... 14
Max. operating voltage	250 V AC / 30 V DC
Max. operating current	1 A AC / 1 A DC

#### Ordering data

Type	Order No.	Pcs./Pkt.
VAL-MS 350 VF/FM	2856579	1
VAL-MS 350VF	2856582	1

#### Accessories

VAL-MS 350 VF ST	2856595	10
------------------	---------	----

### Type 2 surge protective device VALVETRAB MS

- Universal pluggability
- Also suitable for industry solutions, e.g., in the rail and telecommunications sectors
- Thermal disconnect device for each individual connector
- Optical, mechanical status indication for the individual arresters
- With or without floating remote indication contact
- Mechanical coding of all slots
- Plugs can be checked with CHECKMASTER

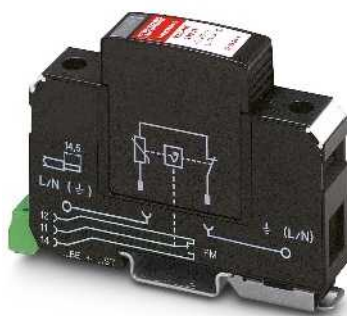

2-conductor system;  
L, N, PEN

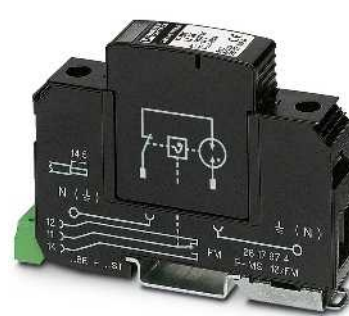

N-PE spark gap

**Notes:**

If only one value is specified under mode of protection in the technical data, this value is valid for all modes of protection specified.

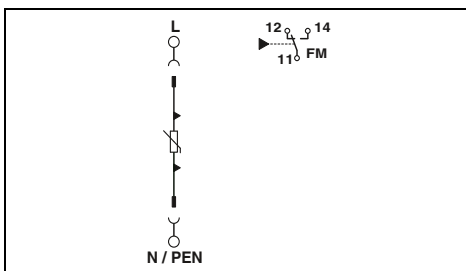

**Technical data**

Electrical data  
IEC test classification  
Nominal voltage  $U_N$

II, T2  
60 V AC (TN)

Mode of protection  
Maximum continuous operating voltage  $U_C$   
Nominal discharge current  $I_n$  (8/20)  $\mu$ s  
Max. discharge current  $I_{max}$  (8/20)  $\mu$ s  
Protection level  $U_p$   
Follow current interrupt rating  $I_{fi}$   
Response time  $t_A$   
Short-circuit current rating  $I_{SCCR}$   
Max. backup fuse with branch wiring

L-PEN  
75 V AC / 100 V DC  
15 kA  
40 kA  
 $\leq 0.55$  kV  
-  
 $\leq 25$  ns  
25 kA  
125 A AC (gG)

General data  
Dimensions W/H/D  
IEC connection data  
UL connection data  
Temperature range  
Test standards  
Remote indication contact  
IEC connection data  
UL connection data  
Max. operating voltage  
Max. operating current

17.6 mm / 97 mm / 65.5 mm  
1.5 ... 35 mm<sup>2</sup> / 1.5 ... 25 mm<sup>2</sup> / 15 ... 2  
10 ... 2  
-40 °C ... 80 °C  
IEC 61643-11 / EN 61643-11  
PDT contact  
0.14 ... 1.5 mm<sup>2</sup> / 0.14 ... 1.5 mm<sup>2</sup> / 28 ... 16  
30 ... 14  
250 V AC / 30 V DC  
1 A AC / 1 A DC

**Ordering data**

Description	Type	Order No.	Pcs./Pkt.
VALVETRAB MS			
with remote indication contact	VAL-MS 60/FM	2868033	1
without remote indication contact	VAL-MS 60	2868020	1

**Accessories**

Replacement plug	Type	Order No.	Pcs./Pkt.
1L-N/PE	VAL-MS 60 ST	2807573	10

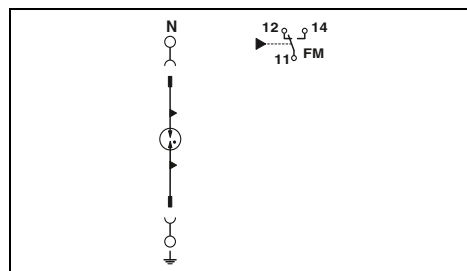

**Technical data**

II, T2  
240/415 V AC (TN - only N-PE) /  
240/415 V AC (TT - only N-PE)

N-PE  
260 V AC  
20 kA  
40 kA  
 $\leq 1.5$  kV  
100 A (260 V)  
 $\leq 100$  ns  
-

17.6 mm / 97 mm / 65.5 mm  
1.5 ... 35 mm<sup>2</sup> / 1.5 ... 25 mm<sup>2</sup> / 15 ... 2  
10 ... 2  
-40 °C ... 80 °C  
IEC 61643-11 / EN 61643-11  
PDT contact  
0.14 ... 1.5 mm<sup>2</sup> / 0.14 ... 1.5 mm<sup>2</sup> / 28 ... 16  
30 ... 14  
250 V AC / 30 V DC  
1 A AC / 1 A DC

**Ordering data**

Type	Order No.	Pcs./Pkt.
F-MS 12/FM	2817974	1
F-MS 12	2817987	1

**Accessories**

Type	Order No.	Pcs./Pkt.
F-MS 12 ST	2817990	10

# Surge protection and interference suppression filters

## Surge protection for the power supply

### Type 2 surge protective device VALVETRAB MS

- For power supplies with higher supply voltages
- Universal pluggability
- Thermal disconnect device for each individual connector
- Optical, mechanical status indication for the individual arresters
- With or without floating remote indication contact
- Mechanical coding of all slots
- Plugs can be checked with CHECKMASTER



Free of leakage current, for nominal voltages up to 690 V AC, e.g., rotor protection for wind turbine generators



4-conductor system; L1, L2, L3, PEN (554/960 V TN-C system)

#### Notes:

If only one value is specified under mode of protection in the technical data, this value is valid for all modes of protection specified.

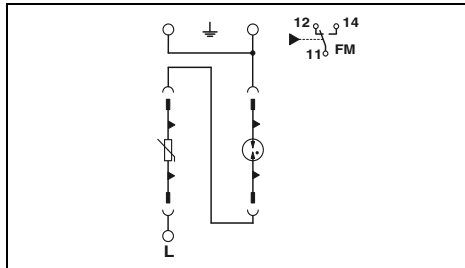

#### Technical data

II, T2  
400/690 V AC (TN-C) /  
690 V AC (IT)  
L-PE / L-PEN  
800 V AC  
15 kA  
30 kA  
≤ 5 kV  
≤ 100 ns  
25 kA  
100 A (gG)

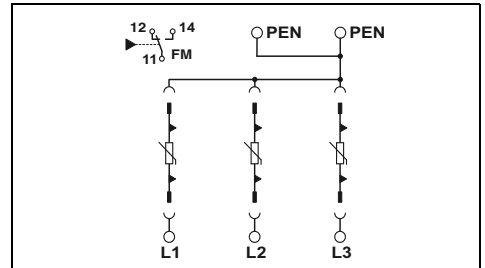

#### Technical data

II, T2  
554/960 V AC (TN-C) /  
690 V AC (IT)  
L-PE / L-PEN  
760 V AC  
15 kA  
30 kA  
≤ 2.9 kV  
≤ 25 ns  
25 kA  
100 A (gG)

Electrical data	
IEC test classification	
Nominal voltage $U_N$	
Mode of protection	
Maximum continuous operating voltage $U_C$	
Nominal discharge current $I_n$ (8/20) $\mu$ s	
Max. discharge current $I_{max}$ (8/20) $\mu$ s	
Protection level $U_p$	
Response time $t_A$	
Short-circuit current rating $I_{SCCR}$	
Max. backup fuse with branch wiring	
General data	
Dimensions W/H/D	
IEC connection data	Solid/stranded/AWG
UL connection data	AWG
Temperature range	
Test standards	
Remote indication contact	
IEC connection data	Solid/stranded/AWG
UL connection data	AWG
Max. operating voltage	
Max. operating current	

#### Ordering data

Type	Order No.	Pcs./Pkt.
VAL-MS 800/30 VF/FM	2805402	1

#### Accessories

Accessories	Order No.	Pcs./Pkt.
VAL-MS 750/30-ST	2920256	10
F-MS 2200/30 ST	2805392	10

#### Ordering data

Type	Order No.	Pcs./Pkt.
VAL-MS 750/30/3+0-FM	2920272	1
VAL-MS 750/30/3+0	2920269	1

#### Accessories

Accessories	Order No.	Pcs./Pkt.
VAL-MS 750/30-ST	2920256	10

Description
VALVETRAB MS, for mounting on NS 35 with remote indication contact
without remote indication contact

Replacement plug	1L-N/PE N-PE
------------------	-----------------



# Surge protection and interference suppression filters

## Surge protection for the power supply

### Type 2 surge protective device VALVETRAB MS

- Custom surge protection configuration
- Optical, mechanical status indicator of the plug
- Disconnect device in the plug
- Base element coding the first time a plug is inserted
- Plugs can be checked with CHECKMASTER



For 24 and 48 V DC



For 120/208 V grounded wye and 120 V split-phase systems

**Notes:**  
 Choose the plug based on technical data.  
 Choose the base element corresponding to the required circuit and remote signaling function:  
 - TN-C: X+0 - circuit  
 - TN-S, TT: X+1 - circuit  
 - IT: Y+0 - circuit  
 - X = Number of phases  
 - Y = Number of phases + if required, neutral conductor  
 The number of plugs required corresponds to the number before the "+" in the circuit data, e.g., 3 plugs in a 3+1 circuit  
 When using a "+1" circuit, the F-MS 12 plug must be used between N and PE. See page 63.

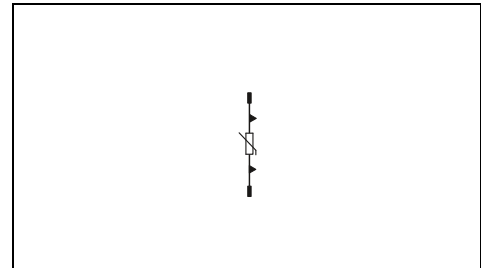
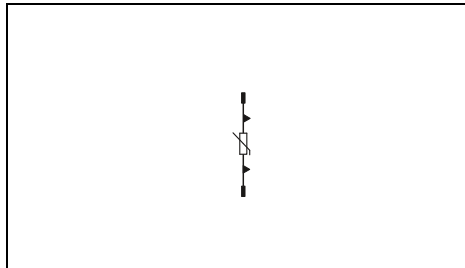

#### Technical data

Electrical data	
IEC test classification	II, T2
Nominal voltage $U_N$ (IEC)	60 V AC (TN)
Nominal voltage $U_N$ (UL)	60 V AC
Maximum continuous operating voltage $U_C$	75 V AC / 100 V DC
Nominal discharge current $I_n$ (8/20) $\mu$ s	15 kA
Max. discharge current $I_{max}$ (8/20) $\mu$ s	40 kA
Protection level $U_p$	$\leq 0.55$ kV
General data	
Dimensions W/H/D	17.5 mm / 52.4 mm / 55.3 mm
Temperature range	-40 °C ... 80 °C
Test standards	IEC 61643-11 / EN 61643-11

#### Technical data

Electrical data	
IEC test classification	II, T2
Nominal voltage $U_N$ (IEC)	120/208 V AC (TN)
Nominal voltage $U_N$ (UL)	120 V AC
Maximum continuous operating voltage $U_C$	150 V AC
Nominal discharge current $I_n$ (8/20) $\mu$ s	20 kA
Max. discharge current $I_{max}$ (8/20) $\mu$ s	40 kA
Protection level $U_p$	$\leq 0.9$ kV
General data	
Dimensions W/H/D	17.5 mm / 52.4 mm / 55.3 mm
Temperature range	-40 °C ... 80 °C
Test standards	IEC 61643-11 / EN 61643-11

#### Ordering data

Description	
VALVETRAB surge protection plug	

Type	Order No.	Pcs./Pkt.
VAL-MS 60 ST	2807573	10

#### Ordering data

Type	Order No.	Pcs./Pkt.
VAL-MS 120 ST	2807586	10

#### Accessories

Base element, with RI contact	
orthogonal	1+0
	1+0
	1+1
	2+0
orthogonal	2+0
	3+0
	3+1
	4+0
Base element, without RI contact	
orthogonal	1+0
	1+0
	1+1
	2+0
	3+0
	3+1

Accessories	Order No.	Pcs./Pkt.
VAL-MS BE/FM	2817738	10
VAL-MS-T1/T2 BE/O-FM	2905652	12
VAL-MS/2+0-BE/FM	2805321	1
VAL-MS BE/2+0/1 U/FM	2907037	1
VAL-MS BE	2817741	10
VAL-MS-T1/T2 BE/O	2905650	12
VAL-MS/2+0-BE	2804584	1

#### Accessories

Accessories	Order No.	Pcs./Pkt.
VAL-MS BE/FM	2817738	10
VAL-MS-T1/T2 BE/O-FM	2905652	12
VAL-MS/1+1-BE/FM	2920531	1
VAL-MS/3+1-BE/FM	2838898	1
VAL-MS BE	2817741	10
VAL-MS-T1/T2 BE/O	2905650	12
VAL-MS/1+1-BE	2920528	1
VAL-MS/3+1-BE	2838885	1



For 240/415 V TN and TT systems, as well as high-leg delta systems



For 240/415 V TN and TT systems, marking rotated 180°



For 240/415 V TN and TT systems with significantly higher voltage fluctuations

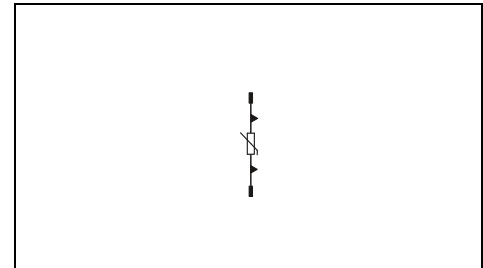
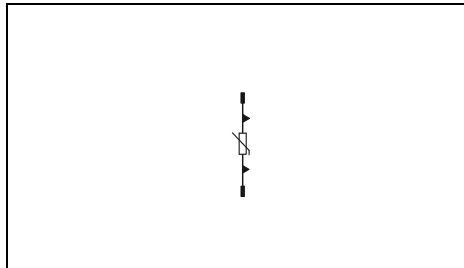
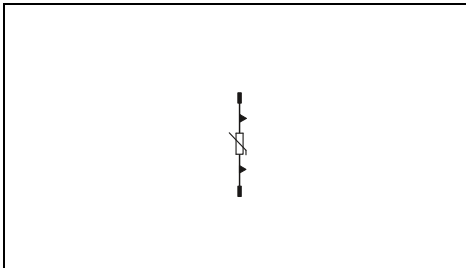

### Technical data

II, T2  
240/415 V AC (TN) /  
240/415 V AC (TT)

230 V AC  
275 V AC  
20 kA  
40 kA  
≤ 1.35 kV

17.5 mm / 52.4 mm / 55.3 mm  
-40 °C ... 80 °C  
IEC 61643-11 / EN 61643-11

### Technical data

II, T2  
240/415 V AC (TN) /  
240/415 V AC (TT)

230 V AC  
275 V AC  
20 kA  
40 kA  
≤ 1.35 kV

17.5 mm / 52.4 mm / 55.3 mm  
-40 °C ... 80 °C  
IEC 61643-11 / EN 61643-11

### Technical data

II, T2  
240/415 V AC (TN) /  
240/415 V AC (TT) /  
230 V AC (IT)

230 V AC  
385 V AC  
20 kA  
40 kA  
≤ 1.8 kV

17.5 mm / 52.4 mm / 55.3 mm  
-40 °C ... 80 °C  
IEC 61643-11 / EN 61643-11

### Ordering data

Type	Order No.	Pcs./Pkt.
VAL-MS 230 ST	2798844	10

### Ordering data

Type	Order No.	Pcs./Pkt.
VAL-MS 230-UD-ST	2858962	1

### Ordering data

Type	Order No.	Pcs./Pkt.
VAL-MS 230 IT ST	2807599	10

### Accessories

VAL-MS BE/FM	2817738	10
VAL-MS-T1/T2 BE/O-FM	2905652	12
VAL-MS/1+1-BE/FM	2920531	1
VAL-MS/2+0-BE/FM	2805321	1
VAL-MS BE/2+0/1 U/FM	2907037	1
VAL-MS/3+0-BE/FM	2881803	1
VAL-MS/3+1-BE/FM	2838898	1
VAL-MS/4+0-BE/FM RN.	2906484	1
VAL-MS BE	2817741	10
VAL-MS-T1/T2 BE/O	2905650	12
VAL-MS/1+1-BE	2920528	1
VAL-MS/2+0-BE	2804584	1
VAL-MS/3+0-BE	2881816	1
VAL-MS/3+1-BE	2838885	1

### Accessories

VAL-MS BE/FM	2817738	10
VAL-MS/3+1-BE/FM-UD	2858674	1
VAL-MS BE	2817741	10

### Accessories

VAL-MS BE/FM	2817738	10
VAL-MS-T1/T2 BE/O-FM	2905652	12
VAL-MS/1+1-BE/FM	2920531	1
VAL-MS/2+0-BE/FM	2805321	1
VAL-MS BE/2+0/1 U/FM	2907037	1
VAL-MS/3+0-BE/FM	2881803	1
VAL-MS/3+1-BE/FM	2838898	1
VAL-MS/4+0-BE/FM RN.	2906484	1
VAL-MS BE	2817741	10
VAL-MS-T1/T2 BE/O	2905650	12
VAL-MS/1+1-BE	2920528	1
VAL-MS/2+0-BE	2804584	1
VAL-MS/3+0-BE	2881816	1
VAL-MS/3+1-BE	2838885	1

# Surge protection and interference suppression filters

## Surge protection for the power supply

### Type 2 surge protective device VALVETRAB MS

- Custom surge protection configuration
- Optical, mechanical status indicator of the plug
- Disconnect device in the plug
- Base element coding the first time a plug is inserted
- Plugs can be checked with CHECKMASTER



For IT systems with a voltage of 230 V phase-phase



For 240/415 V TN and TT systems with higher voltage fluctuations

**Notes:**  
Choose the plug based on technical data.  
Choose the base element corresponding to the required circuit and remote signaling function:  
- TN-C: X+0 - circuit  
- TN-S, TT: X+1 - circuit  
- IT: Y+0 - circuit  
- X = Number of phases  
- Y = Number of phases + if required, neutral conductor  
The number of plugs required corresponds to the number before the "+" in the circuit data, e.g., 3 plugs in a 3+1 circuit  
When using a "+1" circuit, the F-MS 12 plug must be used between N and PE. See page 63.

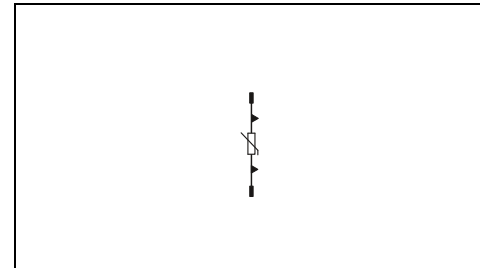
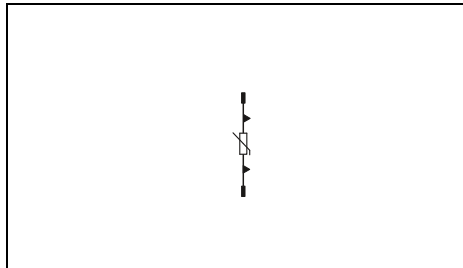

#### Technical data

Electrical data	
IEC test classification	II, T2
Nominal voltage $U_N$ (IEC)	240/415 V AC (TN) / 240/415 V AC (TT) / 230 V AC (IT)
Nominal voltage $U_N$ (UL)	230 V AC
Maximum continuous operating voltage $U_C$	385 V AC
Nominal discharge current $I_n$ (8/20) $\mu$ s	20 kA
Max. discharge current $I_{max}$ (8/20) $\mu$ s	40 kA
Protection level $U_p$	$\leq 1.8$ kV
General data	
Dimensions W/H/D	17.5 mm / 52.4 mm / 55.3 mm
Temperature range	-40 °C ... 80 °C
Test standards	IEC 61643-11 / EN 61643-11

#### Technical data

Electrical data	
IEC test classification	II, T2
Nominal voltage $U_N$ (IEC)	240/415 V AC (TN) / 240/415 V AC (TT)
Nominal voltage $U_N$ (UL)	320 V AC
Maximum continuous operating voltage $U_C$	335 V AC
Nominal discharge current $I_n$ (8/20) $\mu$ s	20 kA
Max. discharge current $I_{max}$ (8/20) $\mu$ s	40 kA
Protection level $U_p$	$\leq 1.5$ kV
General data	
Dimensions W/H/D	17.5 mm / 52.4 mm / 55.3 mm
Temperature range	-40 °C ... 80 °C
Test standards	IEC 61643-11 / EN 61643-11

#### Ordering data

Description	
VALVETRAB surge protection plug	

Type	Order No.	Pcs./Pkt.
VAL-MS 230 IT ST	2807599	10

#### Ordering data

Type	Order No.	Pcs./Pkt.
VAL-MS 320 ST	2838843	10

#### Accessories

<b>Base element, with RI contact</b>		
orthogonal	1+0	VAL-MS BE/FM
	1+0	VAL-MS-T1/T2 BE/O-FM
	1+1	
	2+0	VAL-MS/2+0-BE/FM
orthogonal	2+0	VAL-MS BE/2+0/1U/FM
	3+0	VAL-MS/3+0-BE/FM
	3+1	
	4+0	VAL-MS/4+0-BE/FM RN.
<b>Base element, without RI contact</b>		
orthogonal	1+0	VAL-MS BE
	1+0	VAL-MS-T1/T2 BE/O
	1+1	
	2+0	VAL-MS/2+0-BE
	3+0	VAL-MS/3+0-BE
	3+1	

Type	Order No.	Pcs./Pkt.
VAL-MS BE/FM	2817738	10
VAL-MS-T1/T2 BE/O-FM	2905652	12
VAL-MS/2+0-BE/FM	2805321	1
VAL-MS BE/2+0/1U/FM	2907037	1
VAL-MS/3+0-BE/FM	2881803	1
VAL-MS/4+0-BE/FM RN.	2906484	1
VAL-MS BE	2817741	10
VAL-MS-T1/T2 BE/O	2905650	12
VAL-MS/2+0-BE	2804584	1
VAL-MS/3+0-BE	2881816	1

#### Accessories

Type	Order No.	Pcs./Pkt.
VAL-MS BE/FM	2817738	10
VAL-MS-T1/T2 BE/O-FM	2905652	12
VAL-MS/1+1-BE/FM	2920531	1
VAL-MS/2+0-BE/FM	2805321	1
VAL-MS BE/2+0/1U/FM	2907037	1
VAL-MS/3+0-BE/FM	2881803	1
VAL-MS/3+1-BE/FM	2838898	1
VAL-MS/4+0-BE/FM RN.	2906484	1
VAL-MS BE	2817741	10
VAL-MS-T1/T2 BE/O	2905650	12
VAL-MS/1+1-BE	2920528	1
VAL-MS/2+0-BE	2804584	1
VAL-MS/3+0-BE	2881816	1
VAL-MS/3+1-BE	2838885	1



For 240/415 V TN and TT systems with higher voltage fluctuations, marking rotated 180°



For 240/415 V TN and TT systems with significantly higher voltage fluctuations



For 400/690 V TN systems, 400 V IT systems, 500 V IT systems, with higher voltage fluctuations

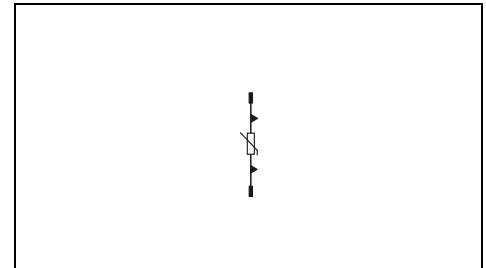
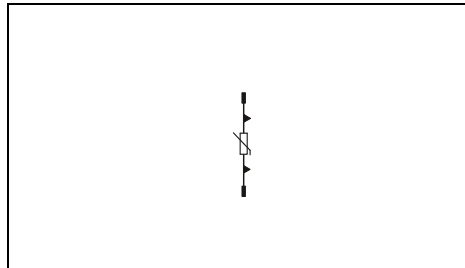
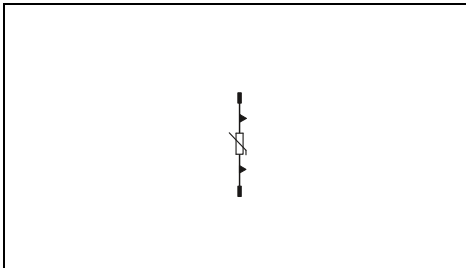

### Technical data

II, T2  
240/415 V AC (TN) /  
240/415 V AC (TT)

320 V AC  
335 V AC  
20 kA  
40 kA  
≤ 1.5 kV

17.5 mm / 52.4 mm / 55.3 mm  
-40 °C ... 80 °C  
IEC 61643-11 / EN 61643-11

### Technical data

II, T2  
240/415 V AC (TN) /  
240/415 V AC (TT) /  
230 V AC (IT)

400 V AC  
440 V AC  
20 kA  
40 kA  
≤ 2.2 kV

17.5 mm / 52.4 mm / 55.3 mm  
-40 °C ... 80 °C  
IEC 61643-11 / EN 61643-11

### Technical data

II, T2  
400/690 V AC (TN) /  
500 V AC (IT)

500 V AC  
600 V AC  
15 kA  
30 kA  
≤ 2.7 kV

17.5 mm / 52.4 mm / 55.3 mm  
-40 °C ... 80 °C  
IEC 61643-11 / EN 61643-11

### Ordering data

Type	Order No.	Pcs./Pkt.
VAL-MS 320-UD ST	2858315	10

### Ordering data

Type	Order No.	Pcs./Pkt.
VAL-MS 400 ST	2816399	10

### Ordering data

Type	Order No.	Pcs./Pkt.
VAL-MS 500 ST	2807609	10

### Accessories

Accessories	Order No.	Pcs./Pkt.
VAL-MS BE/FM	2817738	10
VAL-MS/3+1-BE/FM-UD	2858674	1
VAL-MS BE	2817741	10

### Accessories

Accessories	Order No.	Pcs./Pkt.
VAL-MS BE/FM	2817738	10
VAL-MS-T1/T2 BE/O-FM	2905652	12
VAL-MS/2+0-BE/FM	2805321	1
VAL-MS/2+0/1U/FM	2907037	1
VAL-MS/3+0-BE/FM	2881803	1
VAL-MS/4+0-BE/FM RN.	2906484	1
VAL-MS BE	2817741	10
VAL-MS-T1/T2 BE/O	2905650	12
VAL-MS/2+0-BE	2804584	1
VAL-MS/3+0-BE	2881816	1

### Accessories

Accessories	Order No.	Pcs./Pkt.
VAL-MS BE/FM	2817738	10
VAL-MS-T1/T2 BE/O-FM	2905652	12
VAL-MS/3+0-BE/FM	2881803	1
VAL-MS/4+0-BE/FM RN.	2906484	1
VAL-MS BE	2817741	10
VAL-MS-T1/T2 BE/O	2905650	12
VAL-MS/3+0-BE	2881816	1

# Surge protection and interference suppression filters

## Surge protection for the power supply

### Type 2 surge protective device VALVETRAB MS

- Custom surge protection configuration
- Optical, mechanical status indicator of the plug
- Disconnect device in the plug
- Base element coding the first time a plug is inserted
- Plugs can be checked with CHECKMASTER

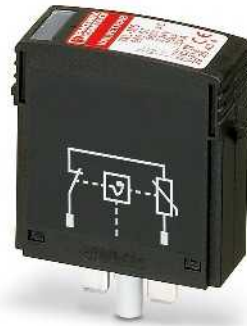

For 400/690 V TN systems, 400 V IT systems, 500 V IT systems, 480 V delta systems

For 24 V DC, 48 V DC with isolation monitoring, free of leakage current

**Notes:**  
Choose the plug based on technical data.  
Choose the base element corresponding to the required circuit and remote signaling function:  
- TN-C: X+0 - circuit  
- TN-S, TT: X+1 - circuit  
- IT: Y+0 - circuit  
- X = Number of phases  
- Y = Number of phases + if required, neutral conductor  
The number of plugs required corresponds to the number before the "+" in the circuit data, e.g., 3 plugs in a 3+1 circuit  
When using a "+1" circuit, the F-MS 12 plug must be used between N and PE. See page 63.

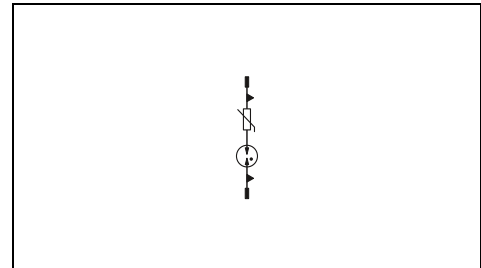
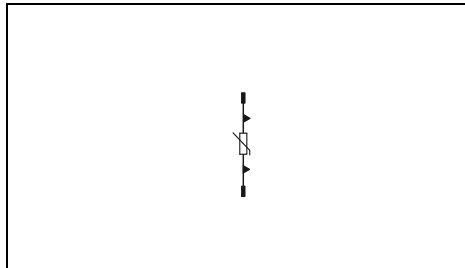

#### Technical data

Electrical data	
IEC test classification	II, T2
Nominal voltage $U_N$ (IEC)	400/690 V AC (TN) / 500 V AC (IT)
Nominal voltage $U_N$ (UL)	400 V AC
Maximum continuous operating voltage $U_C$	580 V AC
Nominal discharge current $I_n$ (8/20) $\mu$ s	15 kA
Max. discharge current $I_{max}$ (8/20) $\mu$ s	30 kA
Protection level $U_p$	$\leq 2.5$ kV
General data	
Dimensions W/H/D	17.5 mm / 52.4 mm / 55.3 mm
Temperature range	-40 °C ... 80 °C
Test standards	IEC 61643-11 / EN 61643-11

#### Technical data

Electrical data	
IEC test classification	II, T2
Nominal voltage $U_N$ (IEC)	5 V AC ... 48 V AC
Nominal voltage $U_N$ (UL)	48 V AC
Maximum continuous operating voltage $U_C$	75 V AC / 100 V DC
Nominal discharge current $I_n$ (8/20) $\mu$ s	10 kA
Max. discharge current $I_{max}$ (8/20) $\mu$ s	20 kA
Protection level $U_p$	$\leq 1.4$ kV
General data	
Dimensions W/H/D	17.5 mm / 52.4 mm / 55.3 mm
Temperature range	-40 °C ... 80 °C
Test standards	IEC 61643-11 / EN 61643-11

#### Ordering data

Description	
VALVETRAB surge protection plug	

Type	Order No.	Pcs./Pkt.
VAL-MS 580-ST	2920434	10

#### Ordering data

Type	Order No.	Pcs./Pkt.
VAL-MS 75 VF ST	2805318	10

#### Accessories

<b>Base element, with RI contact</b>			
orthogonal	1+0	VAL-MS BE/FM	2817738
	1+0	VAL-MS-T1/T2 BE/O-FM	2905652
	1+1		
	2+0		
orthogonal	2+0		
	3+0	VAL-MS/3+0-BE/FM	2881803
	3+1		
	4+0	VAL-MS/4+0-BE/FM RN.	2906484
<b>Base element, without RI contact</b>			
orthogonal	1+0	VAL-MS BE	2817741
	1+0	VAL-MS-T1/T2 BE/O	2905650
	1+1		
	2+0		
	3+0	VAL-MS/3+0-BE	2881816
	3+1		

Type	Order No.	Pcs./Pkt.
VAL-MS BE/FM	2817738	10
VAL-MS-T1/T2 BE/O-FM	2905652	12
VAL-MS/3+0-BE/FM	2881803	1
VAL-MS/4+0-BE/FM RN.	2906484	1
VAL-MS BE	2817741	10
VAL-MS-T1/T2 BE/O	2905650	12
VAL-MS/3+0-BE	2881816	1

#### Accessories

Type	Order No.	Pcs./Pkt.
VAL-MS BE/FM	2817738	10
VAL-MS-T1/T2 BE/O-FM	2905652	12
VAL-MS/1+1-BE/FM	2920531	1
VAL-MS/2+0-BE/FM	2805321	1
VAL-MS BE/2+0/1U/FM	2907037	1
VAL-MS BE	2817741	10
VAL-MS-T1/T2 BE/O	2905650	12
VAL-MS/1+1-BE	2920528	1
VAL-MS/2+0-BE	2804584	1



For 240/415 V TN and TT systems with significantly higher voltage fluctuations, free of leakage current



For 240/415 V TN and TT systems on a spark gap basis, can only be used for N-PE



For 240/415 V TN and TT systems on a spark gap basis, can only be used for N-PE, marking rotated 180°

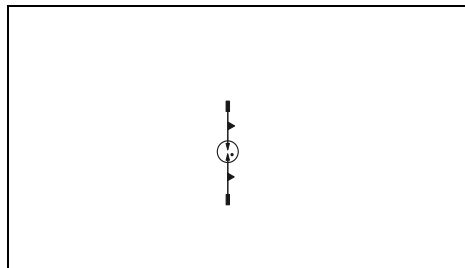
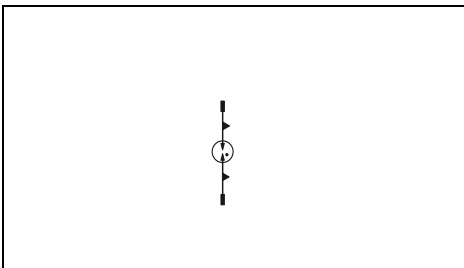
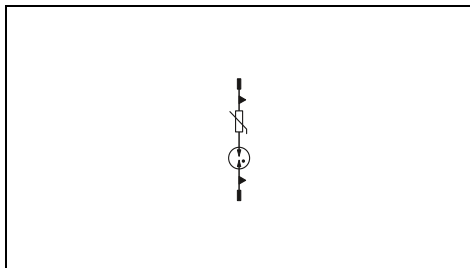

### Technical data

II, T2  
240/415 V AC (TN) /  
240/415 V AC (TT) /  
230 V AC (IT)  
350 V AC  
350 V AC  
10 kA  
20 kA  
≤ 1.5 kV

17.5 mm / 52.4 mm / 55.3 mm  
-40 °C ... 80 °C  
IEC 61643-11 / EN 61643-11

### Technical data

II, T2  
240/415 V AC (TN - only N-PE) /  
240/415 V AC (TT - only N-PE)  
  
- V AC  
260 V AC  
20 kA  
40 kA  
≤ 1.5 kV

17.5 mm / 52.4 mm / 55.3 mm  
-40 °C ... 80 °C  
IEC 61643-11 / EN 61643-11

### Technical data

II, T2  
240/415 V AC (TN - only N-PE) /  
240/415 V AC (TT - only N-PE)  
  
- V AC  
260 V AC  
20 kA  
40 kA  
≤ 1.5 kV

17.5 mm / 52.4 mm / 55.3 mm  
-40 °C ... 80 °C  
IEC 61643-11 / EN 61643-11

### Ordering data

Type	Order No.	Pcs./Pkt.
VAL-MS 350 VF ST	2856595	10

### Accessories

VAL-MS BE/FM	2817738	10
VAL-MS-T1/T2 BE/O-FM	2905652	12
VAL-MS/1+1-BE/FM	2920531	1
VAL-MS/2+0-BE/FM	2805321	1
VAL-MS BE/2+0/1U/FM	2907037	1
VAL-MS/3+0-BE/FM	2881803	1
VAL-MS/3+1-BE/FM	2838898	1
VAL-MS/4+0-BE/FM RN.	2906484	1
VAL-MS BE	2817741	10
VAL-MS-T1/T2 BE/O	2905650	12
VAL-MS/1+1-BE	2920528	1
VAL-MS/2+0-BE	2804584	1
VAL-MS/3+0-BE	2881816	1
VAL-MS/3+1-BE	2838885	1

### Ordering data

Type	Order No.	Pcs./Pkt.
F-MS 12 ST	2817990	10

### Accessories

VAL-MS BE/FM	2817738	10
VAL-MS-T1/T2 BE/O-FM	2905652	12
VAL-MS/1+1-BE/FM	2920531	1
VAL-MS/3+1-BE/FM	2838898	1
VAL-MS BE	2817741	10
VAL-MS-T1/T2 BE/O	2905650	12
VAL-MS/1+1-BE	2920528	1
VAL-MS/3+1-BE	2838885	1

### Ordering data

Type	Order No.	Pcs./Pkt.
F-MS 12-UD ST	2858328	10

### Accessories

VAL-MS BE/FM	2817738	10
VAL-MS/3+1-BE/FM-UD	2858674	1
VAL-MS BE	2817741	10

# Surge protection and interference suppression filters

## Surge protection for the power supply

### Type 2 surge protective device VALVETRAB MB

new

- Double terminal block for safe and easy equipotential bonding connection
- Screw shafts with raised domes to ensure safe working
- Main connections with extended insertion funnels for increased resistance to creepage
- Optical, mechanical status indication for the individual arresters
- Visual display for checking the status directly on the device
- Pluggable signal connection for remote status signaling
- Compact design for space-saving installation



One-piece surge protection for PV applications up to 1500 V DC

KEBA

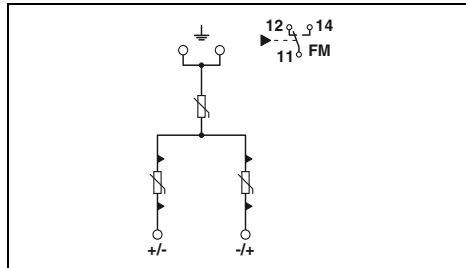

#### Technical data

Electrical data	
IEC test classification	PV II, T2
Mode of protection	(L+) - (L-) / (L+) - PE / (L-) - PE
Maximum continuous operating voltage $U_{CPV}$	1500 V DC
Nominal discharge current $I_n$ (8/20) $\mu$ s	20 kA
Max. discharge current $I_{max}$ (8/20) $\mu$ s	40 kA
Protection level $U_p$	$\leq 4.5$ kV
Response time $t_A$	$\leq 25$ ns
Open circuit voltage $U_{OCSTC}$	$\leq 1250$ V DC
Short-circuit current rating $I_{SCPV}$	2000 A
General data	
Dimensions W/H/D	71.2 mm / 120 mm / 65.5 mm
IEC connection data	Solid/stranded/AWG
Temperature range	- mm <sup>2</sup> / 2.5 ... 35 mm <sup>2</sup> / 14 ... 2
Test standards	-40 °C ... 80 °C
Remote indication contact	EN 50539-11
IEC connection data	PDT contact
Max. operating voltage	0.14 ... 1.5 mm <sup>2</sup> / 0.14 ... 1.5 mm <sup>2</sup> / 28 ... 16
Max. operating current	250 V AC / 5 V DC ... 30 V DC
	1.5 A AC / 5 mA DC ... 1 A DC

#### Ordering data

Description	Type	Order No.	Pcs./Pkt.
<b>VALVETRAB MB...PV</b>			
with remote indication contact	VAL-MB-T2 1500DC-PV/2+V-FM	2905646	1
without remote indication contact	VAL-MB-T2 1500DC-PV/2+V	2905647	1

### Type 2 surge protective device VALVETRAB MS

- Consistently pluggable type 2 surge protective device
- For insulated and single-sided grounded PV applications
- Reliable contact, thanks to integrated rotating latch
- Optical, mechanical status indication for the individual arresters
- With or without floating remote indication contact
- Mechanical coding of all slots
- Plugs can be checked with CHECKMASTER



Pluggable surge protection,  
for PV applications up to  
1000 V DC, 1 MPP tracker



Pluggable surge protection,  
for PV applications up to 1000 V DC,  
3 MPP trackers

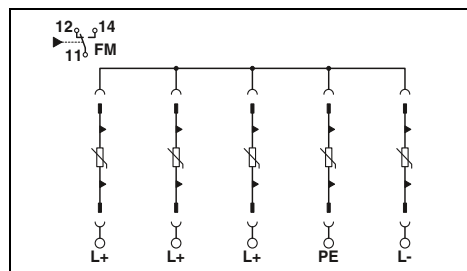
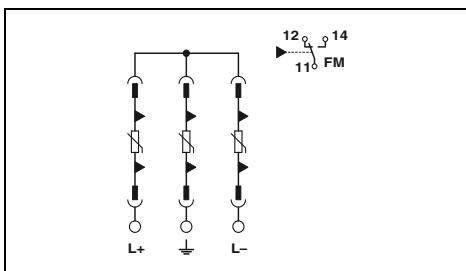

Electrical data	
IEC test classification	PV II, T2
Mode of protection	(L+) - (L-) / (L+) - PE / (L-) - PE
Maximum continuous operating voltage $U_{CPV}$	1170 V DC
Max. discharge current $I_{max}$ (8/20) $\mu$ s	40 kA
Protection level $U_p$	$\leq 3.7$ kV
Response time $t_A$	$\leq 25$ ns
Open circuit voltage $U_{OCSTC}$	$\leq 970$ V DC
Short-circuit current rating $I_{SCPV}$	1000 A
General data	
Dimensions W/H/D	53.4 mm / 99 mm / 65.5 mm
IEC connection data	Solid/stranded/AWG
UL connection data	AWG
Temperature range	-40 °C ... 80 °C
Test standards	EN 50539-11
Remote indication contact	PDT contact
IEC connection data	0.14 ... 1.5 mm <sup>2</sup> / 0.14 ... 1.5 mm <sup>2</sup> / 28 ... 16
UL connection data	30 ... 14
Max. operating voltage	250 V AC / 30 V DC
Max. operating current	1.5 A AC / 1 A DC

Technical data		
... 1000DC	... 600DC	... 1000DC
PV II, T2	PV II, T2	PV II, T2
(L+) - (L-) / (L+) - PE / (L-) - PE	(L+) - (L-) / (L+) - PE / (L-) - PE	(L+) - (L-) / (L+) - PE / (L-) - PE
1170 V DC	800 V DC	1170 V DC
40 kA	40 kA	40 kA
$\leq 3.7$ kV	$\leq 2.7$ kV	$\leq 3.8$ kV
$\leq 25$ ns	$\leq 25$ ns	$\leq 25$ ns
$\leq 970$ V DC	$\leq 670$ V DC	$\leq 970$ V DC
1000 A	1000 A	1000 A
General data		
Dimensions W/H/D	53.4 mm / 99 mm / 65.5 mm	89 mm / 98.57 mm / 64.7 mm
IEC connection data	1.5 ... 35 mm <sup>2</sup> / 1.5 ... 25 mm <sup>2</sup> / 15 ... 2	1.5 ... 35 mm <sup>2</sup> / 1.5 ... 25 mm <sup>2</sup> / 15 ... 2
UL connection data	10 ... 2	10 ... 2
Temperature range	-40 °C ... 80 °C	-40 °C ... 85 °C
Test standards	EN 50539-11	EN 50539-11
Remote indication contact	PDT contact	PDT contact
IEC connection data	0.14 ... 1.5 mm <sup>2</sup> / 0.14 ... 1.5 mm <sup>2</sup> / 28 ... 16	0.14 ... 1.5 mm <sup>2</sup> / 0.14 ... 1.5 mm <sup>2</sup> / 28 ... 16
UL connection data	30 ... 14	30 ... 14
Max. operating voltage	250 V AC / 30 V DC	125 V AC / 30 V DC
Max. operating current	1.5 A AC / 1 A DC	3 A AC / 3 A DC

Technical data		
... 1000DC	... 600DC	... 1000DC
PV II, T2	PV II, T2	PV II, T2
(L+) - (L-) / (L+) - PE / (L-) - PE	(L+) - (L-) / (L+) - PE / (L-) - PE	(L+) - (L-) / (L+) - PE / (L-) - PE
1170 V DC	800 V DC	1170 V DC
40 kA	40 kA	40 kA
$\leq 3.7$ kV	$\leq 2.7$ kV	$\leq 3.8$ kV
$\leq 25$ ns	$\leq 25$ ns	$\leq 25$ ns
$\leq 970$ V DC	$\leq 670$ V DC	$\leq 970$ V DC
1000 A	1000 A	1000 A
General data		
Dimensions W/H/D	53.4 mm / 99 mm / 65.5 mm	89 mm / 98.57 mm / 64.7 mm
IEC connection data	1.5 ... 35 mm <sup>2</sup> / 1.5 ... 25 mm <sup>2</sup> / 15 ... 2	1.5 ... 35 mm <sup>2</sup> / 1.5 ... 25 mm <sup>2</sup> / 15 ... 2
UL connection data	10 ... 2	10 ... 2
Temperature range	-40 °C ... 80 °C	-40 °C ... 85 °C
Test standards	EN 50539-11	EN 50539-11
Remote indication contact	PDT contact	PDT contact
IEC connection data	0.14 ... 1.5 mm <sup>2</sup> / 0.14 ... 1.5 mm <sup>2</sup> / 28 ... 16	0.14 ... 1.5 mm <sup>2</sup> / 0.14 ... 1.5 mm <sup>2</sup> / 28 ... 16
UL connection data	30 ... 14	30 ... 14
Max. operating voltage	250 V AC / 30 V DC	125 V AC / 30 V DC
Max. operating current	1.5 A AC / 1 A DC	3 A AC / 3 A DC

Description	
<b>VALVETRAB MS...PV</b>	
with remote indication contact	
without remote indication contact	
with remote indication contact	
without remote indication contact	

Ordering data			
Type	Order No.	Pcs./Pkt.	
VAL-MS 1000DC-PV/2+V-FM	2800627	1	
VAL-MS 1000DC-PV/2+V	2800628	1	
VAL-MS 600DC-PV/2+V-FM	2800641	1	
VAL-MS 600DC-PV/2+V	2800642	1	

Ordering data			
Type	Order No.	Pcs./Pkt.	
VAL-MS-CN 1000DC-PV/4+V-FM	2907820	1	

Replacement plug	
1000 V DC	
600 V DC	

Accessories			
VAL-MS 1000DC-PV-ST	2800624	1	
VAL-MS 600DC-PV-ST	2800623	1	

Accessories			
VAL-MS 4+V/BE/FM	2908725	1	

# Surge protection and interference suppression filters

## Surge protection for the power supply

### Type 2 surge protective device VALVETRAB combi MCB

- Combinations of type 2 arresters with integrated arrester backup fuse
- Overload of the surge protection results in all-pos. disconnection from the mains
- Signaling to monitoring systems via remote indication contact in the event of an error
- Surge-proof arrester backup fuse tailored to type 2 arresters
- Consistently pluggable type 2 surge protective device
- Disconnect device on each individual connector
- Optical, mechanical status indication for all protective plugs
- Plugs can be checked with CHECKMASTER

**Notes:**  
If only one value is specified under mode of protection in the technical data, this value is valid for all modes of protection specified.



5-conductor system; L1, L2, L3, N, PE  
With integrated backup fuse

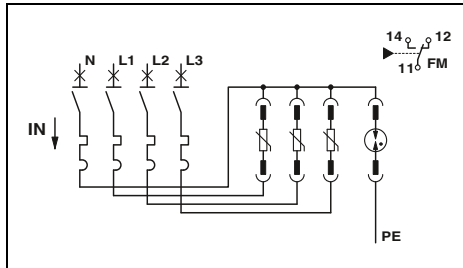

Technical data	
... 3S-350	... 1S-350
II, T2	II, T2
240/415 V AC (TN-S) / 240/415 V AC (TT)	240 V AC (TN-S) / 240 V AC (TT)
L-N / L-PE / N-PE	L-N / L-PE / N-PE
350 V AC / 350 V AC / 264 V AC	350 V AC / 350 V AC / 264 V AC
20 kA	20 kA
30 kA	30 kA
≤ 2.5 kV / - / ≤ 1.7 kV	≤ 2.5 kV / - / ≤ 1.7 kV
- / - / 100 A	- / - / 100 A
≤ 25 ns / ≤ 100 ns / ≤ 100 ns	≤ 25 ns / ≤ 100 ns / ≤ 100 ns
25 kA	25 kA

Ordering data		
Type	Order No.	Pcs./Pkt.
VAL-CP-MCB-3S-350/40/FM	2882750	1
VAL-CP-MCB-1S-350/40/FM	2882763	1

Accessories		
Type	Order No.	Pcs./Pkt.
VAL-CP-350-ST-GY	2882718	10
VAL-CP-N/PE-350-ST-GY	2882734	10



4-conductor system; L1, L2, L3, PEN  
With integrated backup fuse

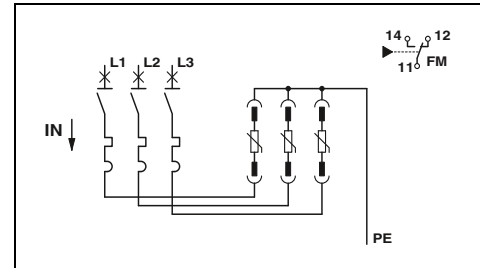

Technical data	
... 3C-350	... 1C-350
II, T2	II, T2
240/415 V AC (TN-C)	240 V AC (TN-S) / 240 V AC (TT)
L-PEN	L-N / L-PE / N-PE
350 V AC	350 V AC / 350 V AC / 264 V AC
20 kA	20 kA
30 kA	30 kA
≤ 2.5 kV	≤ 2.5 kV / - / ≤ 1.7 kV
-	- / - / 100 A
≤ 25 ns	≤ 25 ns / ≤ 100 ns / ≤ 100 ns
25 kA	25 kA

Ordering data		
Type	Order No.	Pcs./Pkt.
VAL-CP-MCB-3C-350/40/FM	2882776	1

Accessories		
Type	Order No.	Pcs./Pkt.
VAL-CP-350-ST-GY	2882718	10

Electrical data	
IEC test classification	
Nominal voltage $U_N$	
Mode of protection	
Maximum continuous operating voltage $U_C$	
Nominal discharge current $I_n$ (8/20) $\mu$ s	
Max. discharge current $I_{max}$ (8/20) $\mu$ s	
Protection level $U_p$	
Follow current interrupt rating $I_{fi}$	
Response time $t_A$	
Short-circuit current rating $I_{SCCR}$	
General data	
Dimensions W/H/D	
IEC connection data	Solid/stranded/AWG
Temperature range	
Test standards	
Remote indication contact	
IEC connection data	Solid/stranded/AWG
Max. operating voltage	
Max. operating current	

Description	
VALVETRAB compact, with an arrester backup fuse	
3-phase	
1-phase	

Replacement plug	L-N / L-PEN N-PE
------------------	---------------------

### Type 2 surge protective device VALVETRAB combi RCD

- Combination of type 2 surge protective device and RCD residual current circuit breaker
- Personal protection and surge protection in one device
- Consistently pluggable type 2 surge protective device
- Disconnect device on each individual connector
- Optical, mechanical status indication for all protective plugs
- Residual current circuit breaker is not triggered by magnetic influences caused by discharge currents in the type 2 arrester
- Plugs can be checked with CHECKMASTER

**Notes:**  
If only one value is specified under mode of protection in the technical data, this value is valid for all modes of protection specified.



**5-conductor system; L1, L2, L3, N, PE  
With selective RCD residual current circuit breaker, 300 mA**

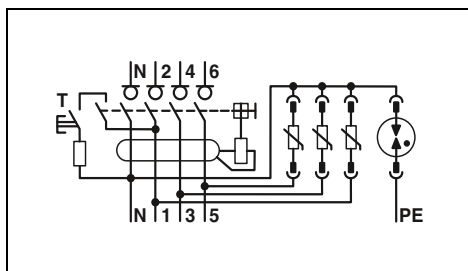

#### Technical data

II, T2  
240/415 V AC (TN-S) /  
240/415 V AC (TT)  
L-N / L-PE / N-PE  
350 V AC / - / 264 V AC  
20 kA  
30 kA  
≤ 2 kV / - / ≤ 2 kV  
- / - / 100 A (264 V AC)  
≤ 25 ns / - / ≤ 100 ns  
10 kA  
63 A AC (MCB)

**Electrical data**  
IEC test classification  
Nominal voltage  $U_N$

**Mode of protection**  
Maximum continuous operating voltage  $U_C$   
Nominal discharge current  $I_n$  (8/20)  $\mu$ s  
Max. discharge current  $I_{max}$  (8/20)  $\mu$ s  
Protection level  $U_p$   
Follow current interrupt rating  $I_{fi}$   
Response time  $t_A$   
Short-circuit current rating  $I_{SCCR}$   
Max. backup fuse with branch wiring

**General data**  
Dimensions W/H/D  
IEC connection data  
Temperature range  
Test standards

**RCD data**  
Tripping characteristic  
Nominal load current  $I_L$   
Rated residual operating current  $I_{\Delta n}$   
Rated making and breaking capacity  $I_m$   
Rated residual making and breaking capacity  $I_{\Delta m}$   
Rated impulse withstand voltage  $U_{imp}$   
Rated conditional short-circuit current  $I_{nc}$   
Tripping time for  $I_{\Delta n}$   
Tripping time for  $5xI_{\Delta n}$   
Switching cycles, max.  
Utilization category

**Description**  
VALVETRAB compact with RCD

**Replacement plug**  
L-N / L-PEN  
N-PE



**5-conductor system; L1, L2, L3, N, PE  
With selective RCD residual current circuit breaker, 30 mA**

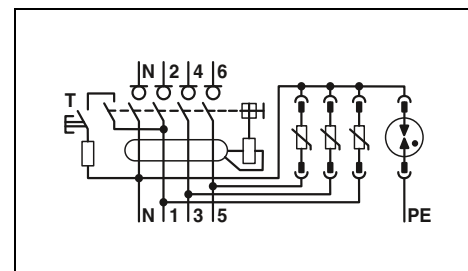

#### Technical data

II, T2  
240/415 V AC (TN-S) /  
240/415 V AC (TT)  
L-N / L-PE / N-PE  
350 V AC / - / 264 V AC  
20 kA  
30 kA  
≤ 2 kV / - / ≤ 2 kV  
- / - / 100 A (264 V AC)  
≤ 25 ns / - / ≤ 100 ns  
10 kA  
63 A (MCB)

**General data**  
Dimensions W/H/D  
IEC connection data  
Temperature range  
Test standards

**RCD data**  
Tripping characteristic  
Nominal load current  $I_L$   
Rated residual operating current  $I_{\Delta n}$   
Rated making and breaking capacity  $I_m$   
Rated residual making and breaking capacity  $I_{\Delta m}$   
Rated impulse withstand voltage  $U_{imp}$   
Rated conditional short-circuit current  $I_{nc}$   
Tripping time for  $I_{\Delta n}$   
Tripping time for  $5xI_{\Delta n}$   
Switching cycles, max.  
Utilization category

**Description**  
VALVETRAB compact with RCD

**Replacement plug**  
L-N / L-PEN  
N-PE

Ordering data			
Type	Order No.	Pcs./Pkt.	
VAL-CP-RCD-3S/40/0.3/SEL	2880001	1	

Accessories			
Type	Order No.	Pcs./Pkt.	
VAL-CP-350-ST-GY	2882718	10	
VAL-CP-N/PE-350-ST-GY	2882734	10	

Ordering data			
Type	Order No.	Pcs./Pkt.	
VAL-CP-RCD-3S/40/0.03	2882802	1	

Accessories			
Type	Order No.	Pcs./Pkt.	
VAL-CP-350-ST-GY	2882718	10	
VAL-CP-N/PE-350-ST-GY	2882734	10	

# Surge protection and interference suppression filters

## Surge protection for the power supply

### Type 2 surge protective device VALVETRAB combi MCB

- Combinations of type 2 arresters with integrated arrester backup fuse
- For 60 mm system technology
- Tool-free mounting on 5 and 10 mm busbars
- Signaling to monitoring systems via remote indication contact in the event of an error
- Surge-proof arrester backup fuse tailored to type 2 arresters
- Consistently pluggable type 2 surge protective device
- Disconnect device on each individual connector
- Optical, mechanical status indication for all protective plugs
- Plugs can be checked with CHECKMASTER

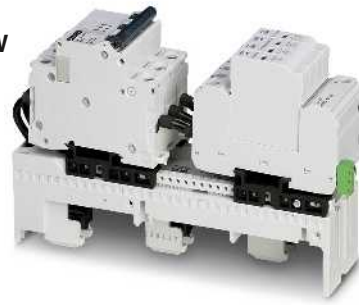

5-conductor system; L1, L2, L3, N, PE  
For 60 mm system technology

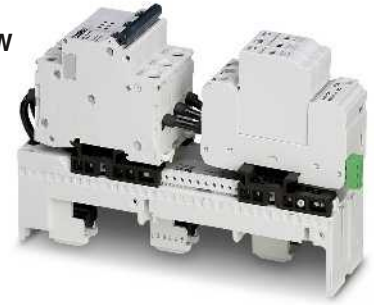

4-conductor system; L1, L2, L3, PEN  
For 60 mm system technology

**Notes:**  
If only one value is specified under mode of protection in the technical data, this value is valid for all modes of protection specified.

ERC

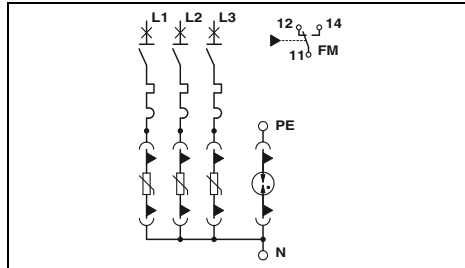

ERC

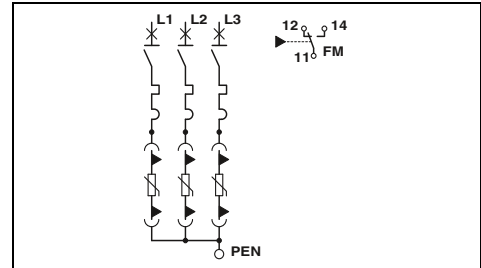

Electrical data	
IEC test classification	
Nominal voltage $U_N$	
Mode of protection	
Maximum continuous operating voltage $U_C$	
Nominal discharge current $I_n$ (8/20) $\mu$ s	
Max. discharge current $I_{max}$ (8/20) $\mu$ s	
Protection level $U_p$	
Response time $t_A$	
Short-circuit current rating $I_{SCCR}$	
General data	
Dimensions W/H/D	
IEC connection data	Solid/stranded/AWG
Temperature range	
Test standards	
Remote indication contact	
IEC connection data	Solid/stranded/AWG
Max. operating voltage	
Max. operating current	

Technical data		
II, T2		
240/415 V AC (TN-S) / 240/415 V AC (TT)		
L-N / L-PE / N-PE		
350 V AC / 350 V AC / 264 V AC		
20 kA		
25 kA / 25 kA / 40 kA		
$\leq 2.5$ kV / - / $\leq 1.5$ kV		
$\leq 25$ ns / $\leq 100$ ns / $\leq 100$ ns		
25 kA		
54 mm / 220 mm / 134 mm		
2.5 ... 25 mm <sup>2</sup> / 2.5 ... 16 mm <sup>2</sup> / 12 ... 4		
-25 °C ... 55 °C		
IEC 61643-11 / EN 61643-11		
PDT contact		
0.14 ... 1.5 mm <sup>2</sup> / 0.14 ... 1.5 mm <sup>2</sup> / 28 ... 16		
250 V AC / 125 V DC (200 mA DC)		
1 A AC / 1 A DC (30 V DC)		

Technical data		
II, T2		
240/415 V AC (TN-C) / 240/415 V AC (TT)		
L-PEN		
350 V AC		
20 kA		
25 kA		
$\leq 2.5$ kV		
$\leq 25$ ns		
25 kA		
54 mm / 220 mm / 134 mm		
2.5 ... 25 mm <sup>2</sup> / 2.5 ... 16 mm <sup>2</sup> / 12 ... 4		
-25 °C ... 55 °C		
IEC 61643-11 / EN 61643-11		
PDT contact		
0.14 ... 1.5 mm <sup>2</sup> / 0.14 ... 1.5 mm <sup>2</sup> / 28 ... 16		
250 V AC / 125 V DC (200 mA DC)		
1 A AC / 1 A DC (30 V DC)		

Description	
VALVETRAB compact	

Ordering data		
Type	Order No.	Pcs./Pkt.
VAL-CP-MOSO 60-3S-FM	2804403	1

Ordering data		
Type	Order No.	Pcs./Pkt.
VAL-CP-MOSO 60-3C-FM	2804416	1

Replacement plug	
L-N / L-PEN	
N-PE	

Accessories		
VAL-CP-350-ST-GY	2882718	10
VAL-CP-N/PE-350-ST-GY	2882734	10

Accessories		
VAL-CP-350-ST-GY	2882718	10

### Type 2 surge protective device for LED applications

- Universal use for street, tunnel or object lighting
- Flexible installation
- Fixed via integrated elongated holes
- Compact design
- Optical, mechanical status indicator
- Connection in branch or through wiring
- Double or reinforced insulation

**Notes:**  
If only one value is specified under mode of protection in the technical data, this value is valid for all modes of protection specified.



For insulation class I



For insulation class II

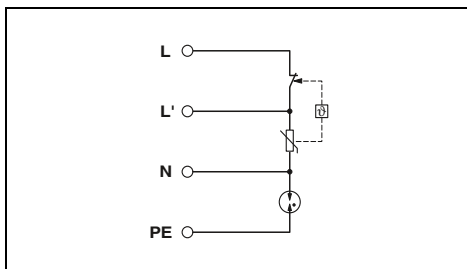

#### Technical data

Electrical data	
IEC test classification	II / III, T2 / T3
Nominal voltage $U_N$	100 V AC ... 277 V AC (TN-S) / 100 V AC ... 277 V AC (TT)
Mode of protection	L-N / L-PE / N-PE
Maximum continuous operating voltage $U_c$	320 V AC / 305 V AC / 305 V AC
Combination wave $U_{OC}$	10 kV
Nominal discharge current $I_n$ (8/20) $\mu$ s	5 kA / 5 kA / 10 kA
Max. discharge current $I_{max}$ (8/20) $\mu$ s	10 kA / 10 kA / 20 kA
Protection level $U_p$	$\leq 1.3$ kV / $\leq 1.5$ kV / $\leq 1.4$ kV
Response time $t_A$	$\leq 25$ ns / - / $\leq 100$ ns
Max. backup fuse with branch wiring	16 A (MCB B/C)
General data	
Dimensions W/H/D	36.5 mm / 56 mm / 34 mm
IEC connection data	Solid/stranded/AWG
Temperature range	0.2 ... 4 mm <sup>2</sup> / 0.2 ... 2.5 mm <sup>2</sup> / -40 °C ... 80 °C
Test standards	IEC 61643-11 / EN 61643-11

Description	<b>BlockTRAB</b> , for universal mounting
-------------	---

Ordering data		
Type	Order No.	Pcs./Pkt.
BLT2-1S-320-UT	2906101	10

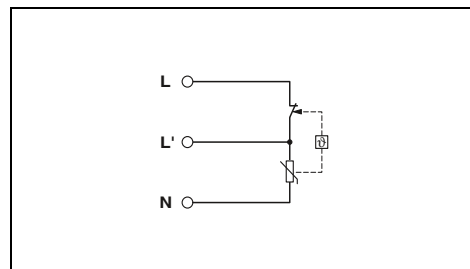

#### Technical data

Electrical data	
IEC test classification	II / III, T2 / T3
Nominal voltage $U_N$	100 V AC ... 277 V AC
Mode of protection	L-N
Maximum continuous operating voltage $U_c$	320 V AC
Combination wave $U_{OC}$	10 kV
Nominal discharge current $I_n$ (8/20) $\mu$ s	5 kA
Max. discharge current $I_{max}$ (8/20) $\mu$ s	10 kA
Protection level $U_p$	$\leq 1.3$ kV
Response time $t_A$	$\leq 25$ ns
Max. backup fuse with branch wiring	16 A (MCB B/C)
General data	
Dimensions W/H/D	36.5 mm / 56 mm / 34 mm
IEC connection data	Solid/stranded/AWG
Temperature range	0.2 ... 4 mm <sup>2</sup> / 0.2 ... 2.5 mm <sup>2</sup> / -40 °C ... 80 °C
Test standards	IEC 61643-11 / EN 61643-11

Ordering data		
Type	Order No.	Pcs./Pkt.
BLT2-320-UT	2906100	10

# Surge protection and interference suppression filters

## Surge protection for the power supply

### Type 2 surge protective device For PCB mounting

- Powerful type 2 surge protection
- Can be soldered directly onto the printed-circuit board
- Very small footprint
- Low height matching standard PCB components
- Optionally available with remote indication contact or visual status indicator
- Safe mechanical disconnection in the event of an overload

new

new



3-conductor system; L, N, PE  
with visual status indicator



3-conductor system; L, N, PE  
with remote indication contact

**Notes:**  
If only one value is specified under mode of protection in the technical data, this value is valid for all modes of protection specified.

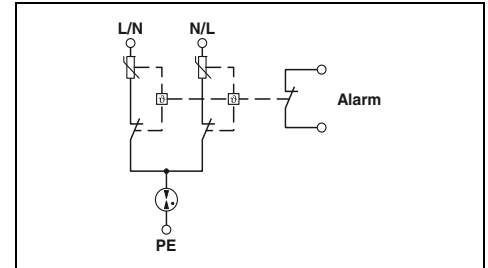
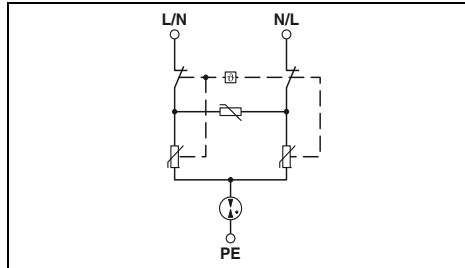

Electrical data	
IEC test classification	II, T2
Nominal voltage $U_N$	230 V AC (TN) / 230 V AC (TT)
Mode of protection	L-N / L-PE / N-PE
Maximum continuous operating voltage $U_C$	350 V AC
Nominal discharge current $I_n$ (8/20) $\mu$ s	5 kA
Protection level $U_p$	$\leq 1.5$ kV
Response time $t_A$	$\leq 25$ ns / $\leq 100$ ns / $\leq 100$ ns
Short-circuit current rating $I_{SCCR}$	1 kA
Max. backup fuse with branch wiring	16 A (MCB C)
General data	
Dimensions W/H/D	24 mm / 15.7 mm / 25.3 mm
Conductive path width	$\geq 12$ mm (2 OZ) / $\geq 8$ mm (3 OZ)
Temperature range	-40 °C ... 70 °C
Test standards	IEC 61643-11
Remote indication contact	
Max. operating voltage	- / -
Max. operating current	- / -

Technical data		
Type	Order No.	Pcs./Pkt.
PRT-1S-350/5S	2908551	1

Technical data	
IEC test classification	II, T2
Nominal voltage $U_N$	230 V AC (TN) / 230 V AC (TT)
Mode of protection	L-N / L-PE / N-PE
Maximum continuous operating voltage $U_C$	350 V AC
Nominal discharge current $I_n$ (8/20) $\mu$ s	20 kA
Protection level $U_p$	$\leq 2.5$ kV / $\leq 1.8$ kV / $\leq 1.8$ kV
Response time $t_A$	$\leq 25$ ns / $\leq 100$ ns / $\leq 100$ ns
Short-circuit current rating $I_{SCCR}$	1 kA
Max. backup fuse with branch wiring	63 A (MCB C)
General data	
Dimensions W/H/D	38.4 mm / 41 mm / 22.4 mm
Conductive path width	$\geq 28$ mm (2 OZ) / $\geq 19$ mm (3 OZ)
Temperature range	-40 °C ... 85 °C
Test standards	IEC 61643-11 / EN 61643-11
Remote indication contact	
Max. operating voltage	250 V AC / 30 V DC
Max. operating current	1 A AC / 1 A DC

Description	
<b>PRINTRAB</b>	

Ordering data		
Type	Order No.	Pcs./Pkt.
PRT-1S-350/5S	2908551	1

Ordering data		
Type	Order No.	Pcs./Pkt.
PRT-1S-350/20/R	2905977	1

### Type 3 device protection PLUGTRAB SEC

- Varistor-based device protection
- For single and three-phase power supply units
- Pluggable
- Through wiring
- Can be used without separate backup fuse thanks to integrated overcurrent protection
- Optical status indicator via LED
- With floating remote indication contact
- Plugs can be checked with CHECKMASTER

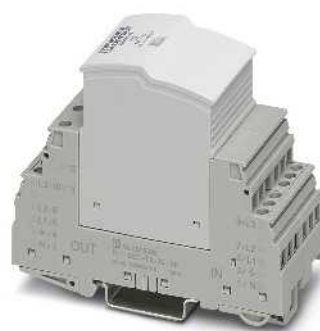

5-conductor system;  
L1, L2, L3, N, PE



3-conductor system;  
L, N, PE

**Notes:**  
If only one value is specified under mode of protection in the technical data, this value is valid for all modes of protection specified.

ERC

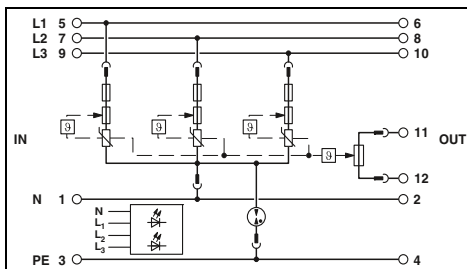

Ex: e

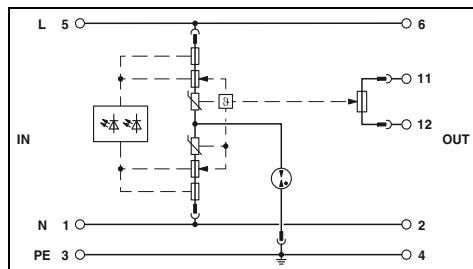

#### Technical data

Electrical data	... 230
IEC test classification	III / T3
Nominal voltage $U_N$	230 V AC
Mode of protection	L-N / L-PE / N-PE
Maximum continuous operating voltage $U_c$	AC/DC 264 V AC / -
Rated load current $I_L$	26 A (30 °C)
Nominal discharge current $I_n$ (8/20) $\mu$ s	3 kA
Combined surge $U_{OC}$	6 kV
Protection level $U_p$	L-N / L(N)-PE $\leq 1.4$ kV / $\leq 1.5$ kV
Response time $t_A$	L-N / L(N)-PE $\leq 25$ ns / $\leq 100$ ns
Short-circuit current rating $I_{SCCR}$	1.5 kA AC
Max. backup fuse with branch wiring	not required
General data	
Dimensions W/H/D	35.4 mm / 90 mm / 74.5 mm
IEC connection data	Solid/stranded/AWG 0.2...4 mm <sup>2</sup> / 0.2...2.5 mm <sup>2</sup> / 24 ... 12
Temperature range	-40 °C ... 70 °C
Test standards	IEC 61643-11 / EN 61643-11
Remote indication contact	N/C contact
IEC connection data	0.2...4 mm <sup>2</sup> / 0.2...2.5 mm <sup>2</sup> / 24 ... 12
Max. operating voltage	250 V AC / 125 V DC
Max. operating current	3 A AC / 1 A DC (30 V DC)

#### Technical data

	... 24	... 60	... 120	... 230
IEC test classification	III / T3	III / T3	III / T3	III / T3
Nominal voltage $U_N$	24 V AC	60 V AC	120 V AC	230 V AC
Mode of protection	L-N / L-PE / N-PE / (L+) - (L-) / (L+/-) - PE	L-N / L-PE / N-PE / (L+) - (L-) / (L+/-) - PE	L-N / L-PE / N-PE / (L+) - (L-) / (L+/-) - PE	L-N / L-PE / N-PE / (L+) - (L-) / (L+/-) - PE
Maximum continuous operating voltage $U_c$	34 V AC / 34 V DC	100 V AC / 80 V DC	150 V AC / 150 V DC	264 V AC / 230 V DC
Rated load current $I_L$	26 A (30 °C)	26 A (30 °C)	26 A (30 °C)	26 A (30 °C)
Nominal discharge current $I_n$ (8/20) $\mu$ s	1 kA	2 kA	3 kA	3 kA
Combined surge $U_{OC}$	2 kV	4 kV	6 kV	6 kV
Protection level $U_p$	$\leq 0.25$ kV / $\leq 0.65$ kV	$\leq 0.48$ kV / $\leq 0.9$ kV	$\leq 0.85$ kV / $\leq 0.95$ kV	$\leq 1.35$ kV / $\leq 1.5$ kV
Response time $t_A$	$\leq 25$ ns / $\leq 100$ ns	$\leq 25$ ns / $\leq 100$ ns	$\leq 25$ ns / $\leq 100$ ns	$\leq 25$ ns / $\leq 100$ ns
Short-circuit current rating $I_{SCCR}$	1.5 kA AC / 1 kA DC	1.5 kA AC / 1 kA DC	1.5 kA AC / 0.25 kA DC	1.5 kA AC / 0.25 kA DC
Max. backup fuse with branch wiring	not required			
General data				
Dimensions W/H/D	17.7 mm / 90 mm / 74.5 mm			
IEC connection data	0.2...4 mm <sup>2</sup> / 0.2...2.5 mm <sup>2</sup> / 24 ... 12			
Temperature range	-40 °C ... 80 °C			
Test standards	IEC 61643-11 / EN 61643-11			
Remote indication contact	N/C contact			
IEC connection data	0.2...4 mm <sup>2</sup> / 0.2...2.5 mm <sup>2</sup> / 24 ... 12			
Max. operating voltage	250 V AC / 125 V DC			
Max. operating current	3 A AC / 1 A DC (30 V DC)			

#### Ordering data

Description	Voltage $U_N$	Type	Order No.	Pcs./Pkt.
MAINS-PLUGTRAB, consisting of a plug and base element	24 V AC 60 V AC 120 V AC 230 V AC	PLT-SEC-T3-3S-230-FM	2905230	1

#### Ordering data

Type	Order No.	Pcs./Pkt.
PLT-SEC-T3-24-FM	2905223	1
PLT-SEC-T3-60-FM	2905225	1
PLT-SEC-T3-120-FM	2905228	1
PLT-SEC-T3-230-FM	2905229	1

#### Accessories

Replacement plug	Voltage $U_N$	Type	Order No.	Pcs./Pkt.
PLUGTRAB base element, for mounting on NS 35	24 V AC 60 V AC 120 V AC 230 V AC	PLT-SEC-T3-3S-230-P	2905236	1

#### Accessories

Type	Order No.	Pcs./Pkt.
PLT-SEC-T3-24-P	2905232	1
PLT-SEC-T3-60-P	2905233	1
PLT-SEC-T3-120-P	2905234	1
PLT-SEC-T3-230-P	2905235	1
PLT-SEC-T3-BE	2905557	1

# Surge protection and interference suppression filters

## Surge protection for the power supply

### Type 3 device protection PLUGTRAB

- For 48 V DC or 230 V IT power supply equipment
- Pluggable
- Through wiring
- Optical status indicator via LED
- Tool-free connector replacement
- With floating remote indication contact
- Plugs can be checked with CHECKMASTER



For 48 V DC power supplies



For 230 V AC power supplies,  
3-conductor system, L1, L2, PE (IT systems)

**Notes:**  
If only one value is specified under mode of protection in the technical data, this value is valid for all modes of protection specified.

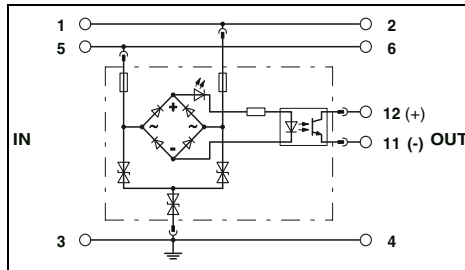

#### Technical data

Electrical data		
IEC test classification		III / T3
Nominal voltage $U_N$		- / 48 V DC
Mode of protection		L-N / L-PE / N-PE / (L+) - (L-) / (L+/L-) - PE
Maximum continuous operating voltage $U_C$	AC/DC	- / 60 V DC
Maximum continuous operating voltage $U_C$	L-N / L-PE	- / -
Rated load current $I_L$		26 A (30 °C)
Nominal discharge current $I_n$ (8/20) $\mu$ s		500 A
Combined surge $U_{OC}$		1 kV (2 $\Omega$ ) / 6 kV (12 $\Omega$ )
Protection level $U_p$		$\leq$ 120 V
Protection level $U_p$	L-N / L(N)-PE	- / -
Response time $t_A$	L-N / L(N)-PE	$\leq$ 1 ns / $\leq$ 1 ns
Backup fuse max. in acc. with IEC		-
General data		
Dimensions W/H/D		17.7 mm / 90 mm / 65.5 mm
IEC connection data	Solid/stranded/AWG	0.2...4 mm <sup>2</sup> / 0.2...2.5 mm <sup>2</sup> / 24 ... 12
Temperature range		-40 °C ... 80 °C
Test standards		EN 61643-11 / IEC 61643-11

#### Ordering data

Description	Type	Order No.	Pcs./Pkt.
<b>MAINS-PLUGTRAB</b> , consisting of a plug and base element	PT 2+1-S-48DC/FM	2817958	10

#### Accessories

Replacement plug	Type	Order No.	Pcs./Pkt.
<b>PLUGTRAB base element</b> , for mounting on NS 35	PT 2+1-S-48DC-ST	2839648	10
	PT-BE/FM	2839282	10

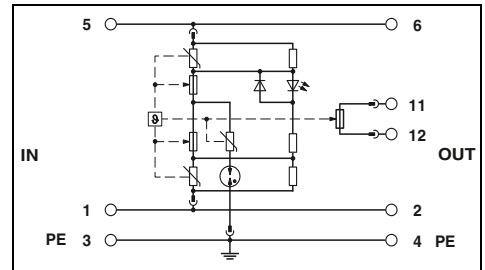

#### Technical data

Electrical data		
IEC test classification		III / T3
Nominal voltage $U_N$		230 V AC
Mode of protection		L-L / L-PE
Maximum continuous operating voltage $U_C$		- / -
Maximum continuous operating voltage $U_C$	275 V AC / 440 V AC	- / -
Rated load current $I_L$		16 A (60 °C)
Nominal discharge current $I_n$ (8/20) $\mu$ s		3 kA
Combined surge $U_{OC}$		6 kV
Protection level $U_p$		-
Protection level $U_p$		$\leq$ 1.2 kV / $\leq$ 1.5 kV
Response time $t_A$		$\leq$ 25 ns / $\leq$ 100 ns
Backup fuse max. in acc. with IEC		16 A (MCB-B)
General data		
Dimensions W/H/D		17.7 mm / 90 mm / 65.5 mm
IEC connection data		0.2...4 mm <sup>2</sup> / 0.2...2.5 mm <sup>2</sup> / 24 ... 12
Temperature range		-40 °C ... 70 °C
Test standards		IEC 61643-11 / EN 61643-11

#### Ordering data

Description	Type	Order No.	Pcs./Pkt.
<b>MAINS-PLUGTRAB</b> , consisting of a plug and base element	PLT-T3-IT-230-FM	2906450	1

#### Accessories

Replacement plug	Type	Order No.	Pcs./Pkt.
<b>PLUGTRAB base element</b> , for mounting on NS 35	PLT-T3-IT-230-P	2906451	1
	PT-BE/FM	2839282	10

### Type 3 device protection BLOCKTRAB

**BT-1S-230AC/...** serves as device protection in deep installation boxes (in acc. with DIN 49073), cable ducts, underfloor systems and terminal devices.

- With double spring-cage terminal blocks for tool-free conductor connection
- Side latches for easy fixing
- Optical/acoustic signaling of disconnection



For universal mounting,  
optical signaling



For universal mounting,  
acoustic signaling

**Notes:**

If only one value is specified under mode of protection in the technical data, this value is valid for all modes of protection specified.

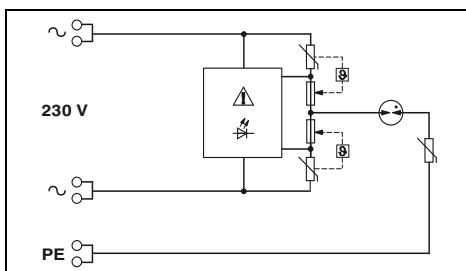

**Technical data**

Electrical data	
IEC test classification	III / T3
Nominal voltage $U_N$	230 V AC
Mode of protection	L-N / L-PE / N-PE
Maximum continuous operating voltage $U_C$	L-N / L-PE 275 V AC / 440 V AC
Rated load current $I_L$	16 A (30 °C)
Nominal discharge current $I_n$ (8/20) $\mu$ s	3 kA
Combined surge $U_{oc}$	6 kV
Protection level $U_p$	L-N / L(N)-PE $\leq 1.3$ kV / $\leq 1.5$ kV
Response time $t_A$	L-N / L(N)-PE $\leq 25$ ns / $\leq 100$ ns
Backup fuse max. in acc. with IEC	16 A (MCB-B)
General data	
Dimensions W/H/D	22.5 mm / 43 mm / 27.4 mm
IEC connection data	Solid/stranded/AWG 0.2...2.5 mm <sup>2</sup> / 0.2...2.5 mm <sup>2</sup> / 24 ... 14
Temperature range	-30 °C ... 75 °C
Test standards	IEC 61643-11 / EN 61643-11

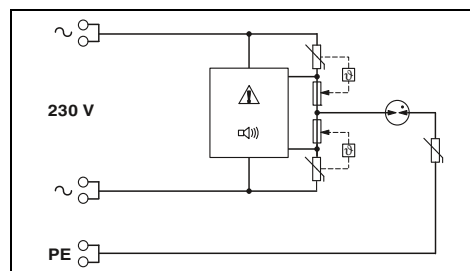

**Technical data**

Electrical data	
IEC test classification	III / T3
Nominal voltage $U_N$	230 V AC
Mode of protection	L-N / L-PE / N-PE
Maximum continuous operating voltage $U_C$	L-N / L-PE 275 V AC / 440 V AC
Rated load current $I_L$	16 A (30 °C)
Nominal discharge current $I_n$ (8/20) $\mu$ s	3 kA
Combined surge $U_{oc}$	6 kV
Protection level $U_p$	L-N / L(N)-PE $\leq 1.3$ kV / $\leq 1.5$ kV
Response time $t_A$	L-N / L(N)-PE $\leq 25$ ns / $\leq 100$ ns
Backup fuse max. in acc. with IEC	16 A (MCB-B)
General data	
Dimensions W/H/D	22.5 mm / 43 mm / 26.2 mm
IEC connection data	Solid/stranded/AWG 0.2...2.5 mm <sup>2</sup> / 0.2...2.5 mm <sup>2</sup> / 24 ... 14
Temperature range	-30 °C ... 75 °C
Test standards	IEC 61643-11 / EN 61643-11

**Ordering data**

Description	Voltage $U_N$	Ordering data		
		Type	Order No.	Pcs./Pkt.
<b>BLOCKTRAB</b> , for universal mounting	230 V AC	<b>BT-1S-230AC/O</b>	<b>2800625</b>	1

**Ordering data**

Description	Voltage $U_N$	Ordering data		
		Type	Order No.	Pcs./Pkt.
<b>BLOCKTRAB</b> , for universal mounting	230 V AC	<b>BT-1S-230AC/A</b>	<b>2803409</b>	10

# Surge protection and interference suppression filters

## Surge protection for the power supply

### Type 3 device protection MAINTRAB

- Attachment plug in black or white
- For individual terminal devices
- With increased touch-proof protection
- Optical signaling of the surge voltage function via LED
- For protecting the power supply and signal lines
- Including required accessories
- Country-specific versions available



Attachment plug



For telecommunications systems with TAE connection

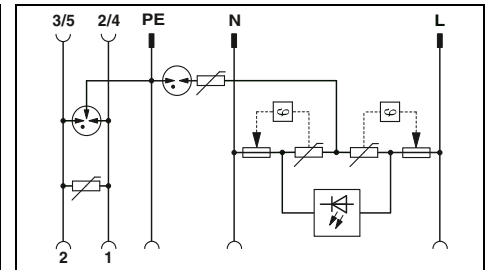
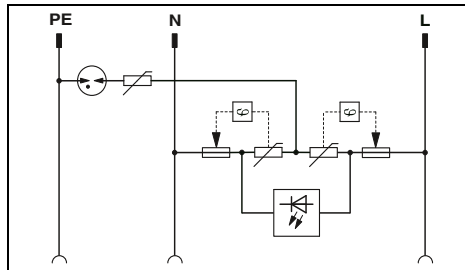

#### Technical data

Electrical data	
IEC test classification/EN type	III / T3
Nominal voltage $U_N$	230 V AC
Maximum continuous operating voltage $U_C$	L-N / L-PE without reference direction 275 V AC / 360 V AC
Combined surge $U_{OC}$	4 kV
Nominal load current $I_L$	16 A (30 °C)
Rated current	-
Nominal discharge current $I_n$ (8/20) $\mu$ s	without reference direction 3 kA (> 5x)
Protection level $U_p$	Core-Core / Core-Ground / Core-Shield L-N / N-PE / L-PE $\leq 1.2$ kV / $\leq 1.5$ kV / $\leq 1.5$ kV Core-Core / Core-Ground / Core-Shield - / - / -
Response time $t_d$	L-N / L-PE $\leq 25$ ns / $\leq 100$ ns Core-Ground / Core-Shield / Shield-Ground - / - / -
Cut-off frequency fg (3 dB)	In a 100 $\Omega$ system Core-Core - In a 75 $\Omega$ system Core-Shield -
General data	
Dimensions W/H/D	56 mm / 76 mm / 78 mm
Temperature range	-25 °C ... 75 °C
Test standards	IEC 61643-11 / EN 61643-11

#### Technical data

Mains protection	Data protection
III / T3	C1
230 V AC	
275 V AC / 360 V AC	200 V DC
4 kV	-
16 A (30 °C)	150 mA (25 °C)
-	1 kA / 2.5 kA / -
3 kA (> 5x)	-
-	$\leq 460$ V (C2 - 1 kA) / $\leq 900$ V (C2 - 2 kA) / -
$\leq 1.2$ kV / $\leq 1.5$ kV / $\leq 1.5$ kV	-
-	$\leq 25$ ns / $\leq 100$ ns
$\leq 25$ ns / $\leq 100$ ns	-
-	$\leq 25$ ns / $\leq 100$ ns / -
-	typ. 4 MHz
-	-
Dimensions W/H/D	
63 mm / 103 mm / 78 mm	
-25 °C ... 75 °C	
IEC 61643-11 / EN 61643-11 / EN 61643-21 /	

#### Ordering data

Description	can be used in the following:
<b>MAINTRAB</b> , attachment plug with signal lamp for plugging into a socket, for device protection	
black	D, A, NL, E, S, FIN, TR
white	D, A, NL, E, S, FIN, TR
black	D
white	D
black	NL, E, I, S, FIN, TR
white	NL, E, I, S, FIN, TR
black	B, F, CZ, SVK, PL
black	CH

Type	Order No.	Pcs./Pkt.
MNT-1 D	2882200	1
MNT-1 D/WH	2882213	1
MNT-NET B/F	2882226	1
MNT-1 CH II	2882255	1

#### Ordering data

Type	Order No.	Pcs./Pkt.
MNT-TAE D	2882381	1
MNT-TAE D/WH	2882394	1



For telecommunications systems with RJ12 connection



For network and TV antennas/cables and SAT systems, with F connector and IEC adapter

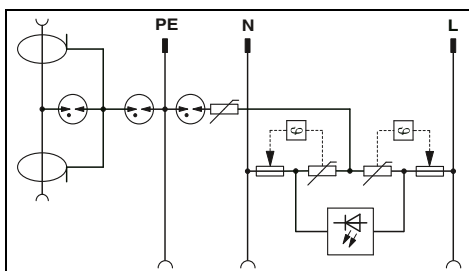
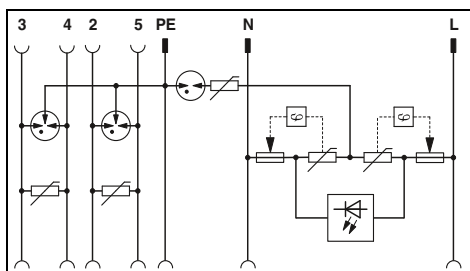

**Technical data**

**Technical data**

Mains protection	Data protection
III / T3 230 V AC	C1
275 V AC / 360 V AC	200 V DC
-	-
4 kV	-
16 A (30 °C)	150 mA (25 °C)
-	-
3 kA (> 5x)	-
-	1 kA / 2.5 kA / -
≤ 1.2 kV / ≤ 1.5 kV / ≤ 1.5 kV	-
-	≤ 460 V (C2 - 1 kA) / ≤ 900 V (C2 - 2 kA) / -
≤ 25 ns / ≤ 100 ns	-
-	≤ 25 ns / ≤ 100 ns / -
-	typ. 4 MHz
-	-

Mains protection	Data protection
III / T3 230 V AC	C2
275 V AC / 360 V AC	24 V DC
-	-
4 kV	-
16 A (30 °C)	1.5 A (25 °C)
-	-
3 kA (> 5x)	-
-	- / 2.5 kA / 2.5 kA
≤ 1.2 kV / ≤ 1.5 kV / ≤ 1.5 kV	-
-	- / - / ≤ 700 V (C2 - 2 kA)
≤ 25 ns / ≤ 100 ns	-
-	- / - / ≤ 100 ns
-	-
-	typ. 2.5 GHz

63 mm / 103 mm / 78 mm  
-25 °C ... 75 °C  
IEC 61643-11 / EN 61643-11 / EN 61643-21 /

63 mm / 107 mm / 78 mm  
-25 °C ... 75 °C  
IEC 61643-11 / EN 61643-11 / EN 61643-21 /

**Ordering data**

**Ordering data**

Type	Order No.	Pcs./Pkt.
MNT-TELE E	2882417	1
MNT-TELE S/WH	2880901	1
MNT-TEL B/F	2882404	1

Type	Order No.	Pcs./Pkt.
MNT-TV-SAT D	2882284	1
MNT-TV-SAT D/WH	2882297	1
MNT-TV-SAT B/F	2882307	1

# Surge protection and interference suppression filters

## Surge protection for the power supply

### Set solution for building installation

- Surge protection set for powerful basic protection
- Coordinated protective devices
- VAL-MS-T1/T2 lightning current arrester for installation in the distribution
- Three device protection adapters (type 3) for protecting the power supply
- Two of these are equipped with additional signal line protection (TV/SAT or TAE)
- Cables and adapters are supplied as standard



Set solution with surge protection for TAE and TV-SAT

ERIC

Description
<b>Building set</b> , consisting of: 1 x VAL-MS-T1/T2 (surge protective device), 1 x MNT-1D (device protection adapter), 1 x MNT-TV-SAT D (device and TV-SAT protective adapter), 1 x MNT-TAE D (device and TAE protective adapter), 2 x adapter F to TV (IEC) connector 1 x KBL TV-SAT/150, 1 x KBL TV/150, 1 x KBL TAE/150 (connecting cable)

Ordering data		
Type	Order No.	Pcs./Pkt.
GEB-SET-T1/T2 TAE/TV-SAT	2801022	1

### Feed-through terminal block and equipotential bonding strip

#### Feed-through terminal block

- For wiring mixed combinations of lightning current arresters and surge protective devices

#### Equipotential bonding strip

- For main equipotential bonding according to DIN VDE 0100
- As well as for lightning protection equipotential bonding in acc. with DIN EN 62305



Feed-through terminal block



Equipotential bonding strip

Technical data		
----------------	--	--

Technical data		
----------------	--	--

Electrical data	
Maximum continuous operating voltage $U_c$	500 V AC
Nominal current $I_N$	-
Impulse discharge curr. $I_{imp}$ (10/350) $\mu$ s	-
Peak value	100 kA
General data	
Dimensions W/H/D	17.7 mm / 89.8 mm / 65.5 mm
Connection data solid/stranded/AWG	0.5...35 mm <sup>2</sup> / - mm <sup>2</sup> / 20 ... 2
Temperature range	-40 °C ... 85 °C
Inflammability class in acc. with UL 94	V-0
Test standards	IEC 60947-7-1 / DIN EN 61643-11 / IEC 61643-1

Ordering data		
---------------	--	--

Ordering data		
---------------	--	--

Description		
<b>Feed-through terminal block</b> with biconnect connecting terminal blocks as wiring aid for lightning current arrester and surge protective device applications.		
<b>Equipotential bonding strip</b>		

Type	Order No.	Pcs./Pkt.
DK-BIC-35	2749880	1

Type	Order No.	Pcs./Pkt.
PAS-1	2765615	1

### Wiring bridges and marking materials

#### Marking material

- For clear and logical identification
- Can be marked with CMS computer marking system or by hand using B-STIFT

#### Wiring bridges

- 1-phase with various numbers of positions

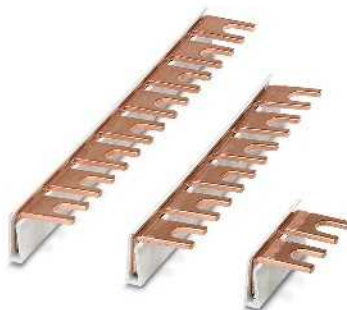

Wiring bridges



Marking label for the SEC product range

Ordering data		
---------------	--	--

Ordering data		
---------------	--	--

Description		
<b>Wiring bridge</b> , for wiring applications with lightning current arresters and surge protective devices; these can be found on the website under the corresponding items		
2-pos.	MPB 18/1- 2	2809209
3-pos.	MPB 18/1- 3	2809212
4-pos.	MPB 18/1- 4	2809225
5-pos.	MPB 18/1- 5	2817864
6-pos.	MPB 18/1- 6	2748564
8-pos.	MPB 18/1- 8	2748577
9-pos.	MPB 18/1- 9	2748580
12-pos.	MPB 18/1-12	2748593
57-pos.	MPB 18/1-57	2809238
<b>Wiring bridge</b> , 35 mm <sup>2</sup>		
6-pos.	MPB 18/1-6/35	2908705
8-pos.	MPB 18/1-8/35	2908704
<b>Continuous roll</b> , width: 20 mm		
Color: white	EML (20XE)R	0803452
Color: yellow	EML (20XE)R YE	0803453

Type	Order No.	Pcs./Pkt.
MPB 18/1- 2	2809209	10
MPB 18/1- 3	2809212	10
MPB 18/1- 4	2809225	10
MPB 18/1- 5	2817864	10
MPB 18/1- 6	2748564	10
MPB 18/1- 8	2748577	10
MPB 18/1- 9	2748580	10
MPB 18/1-12	2748593	10
MPB 18/1-57	2809238	1
MPB 18/1-6/35	2908705	10
MPB 18/1-8/35	2908704	10

Type	Order No.	Pcs./Pkt.
EML (20XE)R	0803452	1
EML (20XE)R YE	0803453	1

- Isolating spark gap for indirect equipotential bonding
- Protection of insulating flanges in pipelines
- Can be used in Ex protection Zone 1
- Accessories for lightning current absorbing connection



Spark gap

Ex:

Electrical data	
Lightning protection class	H
Lightning surge current $I_{imp}$ (10/350) $\mu$ s	100 kA
Nominal discharge current $I_n$ (8/20) $\mu$ s	100 kA
Rated power-frequency withstand voltage $U_{wAC}$	$\leq 250$ V AC
Rated DC withstand voltage $U_{wDC}$	$\leq 354$ V DC
Rated impulse sparkover voltage $U_{t,imp}$	$\leq 1.25$ kV
General data	
Dimensions: length/housing diameter	+2 mm / 45.50 mm
Temperature range	-20 °C ... 60 °C
Test standards	IEC 62561-3 / EN 62561-3
Approvals	
EC-type examination certificate according to ATEX	DEKRA 14ATEX0050 X
ATEX	II 2 G Ex d IIC T6 Gb
	II 2 D Ex tb IIIC T80 °C Db IP 66/67
IECEX	Ex d IIC T6 Gb
	Ex tb IIIC T80 °C Db IP66/67

Technical data		
Lightning protection class		
Lightning surge current $I_{imp}$ (10/350) $\mu$ s		
Nominal discharge current $I_n$ (8/20) $\mu$ s		
Rated power-frequency withstand voltage $U_{wAC}$		
Rated DC withstand voltage $U_{wDC}$		
Rated impulse sparkover voltage $U_{t,imp}$		
Dimensions: length/housing diameter		
Temperature range		
Test standards		
Approvals		
EC-type examination certificate according to ATEX		
ATEX		
IECEX		

Description	Drill hole diameter
Isolating spark gap for the hazardous area	
Fixing bracket	
	11 mm
	14 mm
	18 mm
	22 mm
	26 mm
	30 mm
	33 mm
	36 mm
	39 mm
	42 mm
	48 mm
	56 mm
	62 mm
Mounting rail	
	11 mm
	14 mm
	18 mm
	22 mm
	26 mm
	30 mm
	33 mm
	36 mm
	39 mm
	42 mm
Connecting cable, conductor cross section: 25 mm <sup>2</sup> , conductor designation: H01 N2-D	
	Cable length: 100 mm
	Cable length: 200 mm
	Cable length: 300 mm

Ordering data		
Type	Order No.	Pcs./Pkt.
FLT-ISG-100-EX	2905579	1



Fixing bracket



Mounting rail



Connecting cable

Ordering data			Ordering data			Ordering data		
Type	Order No.	Pcs./Pkt.	Type	Order No.	Pcs./Pkt.	Type	Order No.	Pcs./Pkt.
FLT-ISG-BR-11	2905580	1						
FLT-ISG-BR-14	2905581	1						
FLT-ISG-BR-18	2905582	1						
FLT-ISG-BR-22	2905583	1						
FLT-ISG-BR-26	2905757	1						
FLT-ISG-BR-30	2905758	1						
FLT-ISG-BR-33	2905759	1						
FLT-ISG-BR-36	2905760	1						
FLT-ISG-BR-39	2905761	1						
FLT-ISG-BR-42	2905762	1						
FLT-ISG-BR-48	2905763	1						
FLT-ISG-BR-56	2905764	1						
FLT-ISG-BR-62	2905765	1						
			FLT-ISG-PL-11	2905584	1			
			FLT-ISG-PL-14	2905586	1			
			FLT-ISG-PL-18	2905587	1			
			FLT-ISG-PL-22	2905588	1			
			FLT-ISG-PL-26	2905745	1			
			FLT-ISG-PL-30	2905746	1			
			FLT-ISG-PL-33	2905747	1			
			FLT-ISG-PL-36	2905754	1			
			FLT-ISG-PL-39	2905755	1			
			FLT-ISG-PL-42	2905756	1			
						FLT-ISG-CA-100	2905589	1
						FLT-ISG-CA-200	2905590	1
						FLT-ISG-CA-300	2905591	1



### Surge protection in thin layers – TERMITRAB complete

Starting from an overall width of 3.5 mm, the TERMITRAB complete product range is a tailored product range for almost all applications in measurement and control technology. Depending on the type of signal to be protected, with TERMITRAB complete you will find an ideally suited circuit version in the portfolio.

### Signaling and disconnection

The mechanical status indicator functions without additional auxiliary energy and displays the disconnection of a protective element in the event of an overload. This means you are constantly informed of the status and can replace the overloaded protective device.

### Remote signaling

Thanks to the remote signaling modules that are available as an option, you can decide whether and when you require this feature. To monitor retrospectively, you can easily align remote signaling modules to protective devices that are already installed. If a protective element is disconnected in the event of an overload, the disconnect device closes the monitoring channel and group remote signaling is triggered. The overloaded device is detected on site by the status indicator – and that is purely mechanically, without auxiliary energy.

### Universal use

The areas of application for TERMITRAB complete are so diverse that they can be used in any industry. Thanks to the narrow overall width, starting at 3.5 mm, the product range is ideal for process technology, as very often a high packing density is required in the distribution cabinets. They protect up to 572 signals on one meter, which means that your systems can be made smaller. The various approvals permit use in onshore and offshore systems, e.g., for petrochemicals or wind power. The tailored TERMITRAB complete portfolio offers you the widest range of features, and therefore an optimum product selection for your applications. This means you can reliably protect your signals against surge voltages – from the field to the controller.

### Quick wiring

TERMITRAB complete is available with conventional screw connection and innovative Push-in connection technology. It guarantees quick and easy installation in the control cabinet. At the same time, the Push-in connection technology enables mechanical wiring of the surge protective devices, within the scope of tomorrow's intelligent automation solutions.

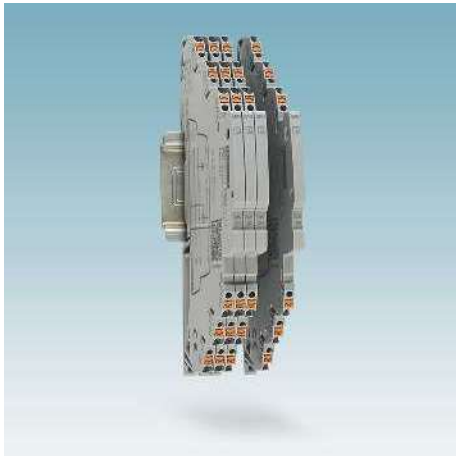

### The narrowest surge protection

Starting from an overall width of 3.5 mm, TERMITRAB complete is the world's first surge protection solution for measurement and control technology.

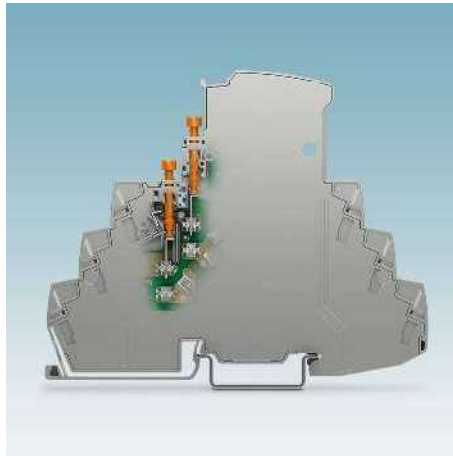

### Innovative knife disconnection

The integrated knife disconnection enables the signal path to be broken up, e.g., to carry out isolation measurements. An open signal path is easy to detect from the projecting function screws. The screws are equipped with overwind protection.



### Optional visual remote signaling

Up to 40 protective devices are visually monitored with the optional remote signaling modules. Add further protective devices easily to the monitoring system without additional wiring effort.



### Plug in, remove, and test

For repeated tests, remove the connectors of multi-piece protective devices without impedance. The signals are not interrupted and the controllers do not immediately detect an impedance change in the measuring circuit. Testing and documentation takes place in the CHECKMASTER 2. If a replacement is required, the affected connector is simply replaced without accessing the installation.

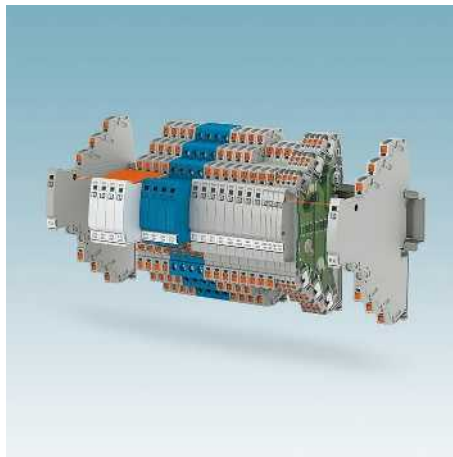

### Tailored portfolio

The portfolio ranges from single-stage, one-piece protective devices to multi-stage pluggable versions. A range of voltage and circuit versions that are optimized for different applications and various connection technologies complete the product range.



### Versatile

Certain applications require special tests and approvals. TERMITRAB complete meets the requirements of Underwriters Laboratories (UL). Furthermore, versions with ATEX, IEC Ex, and GL approvals are available.



### Intelligent and systematic surge protection – PLUGTRAB PT-IQ

The PLUGTRAB PT-IQ product range is the first to offer predictive function monitoring for surge protective devices in the context of measurement and control technology. Boasting a whole range of additional features, the new surge protection system is a real highlight from Phoenix Contact.

### Always know what is happening – predictive monitoring

The individual components of the protective devices are permanently monitored. When the performance limit has been reached as a result of frequent surge voltages, this is indicated by the yellow status symbol. The arrester continues to function and your system is still protected. However, replacement of the protective plug is recommended. This ensures you are informed even earlier and can replace your surge protection before the protective plug is overloaded (red signal). Furthermore, if you use the remote signaling option, you can check how well your system is being protected – at any time and from any location.

### Permanent and error-free installation

The PLUGTRAB PT-IQ minimizes the amount of wiring required. This is made possible by the DIN rail connector (TBUS), which is easily clipped onto the DIN rail. A controller handles the distribution of the power supply and implements remote signaling of all connected surge protective devices via the TBUS. All you have to do then is install the surge protective devices on the TBUS – and you're done! The plug and base element are coded to avoid installation errors during replacement.

### Limitless extension

The controller monitors all arresters which are connected to the controller via the TBUS. You can bridge the TBUS across DIN rails to monitor even more protective devices. After 28 protective devices, an additional controller must be installed to supply voltage. Remote signaling can be performed from any controller in the system.

### Other surge protective devices

PLUGTRAB PT are pluggable protective devices without remote signaling, also with circuit versions for intrinsically safe signal circuits.

The multi-level terminal blocks in the TERMITRAB or LINETRAB product ranges have an overall width of just 6.2 mm yet are able to offer protection for up to four signal wires.

As they are installed directly on measuring sensors, the SURGETRAB screw connection modules are able to provide reliable protection against transients even in Ex i and Ex d applications.

The products in the COMTRAB modular range have been designed specifically for use in marshalling distributors.

**i** Your web code: #0144



### Group message

- Green: protective device OK
- Yellow: performance limit reached, replacement recommended
- Red: protective device overloaded, replace



### Multi-stage remote signaling

Connect the remote signaling to the controller that acts as a supply and remote module (one-off connection operation). The status is output according to the priority as red, yellow or green. This ensures you always know what is happening and can always keep an eye on your system's protection.

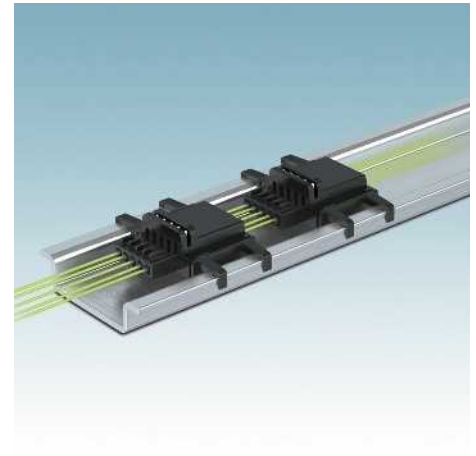

### TBUS DIN rail connector

The DIN rail connector (TBUS) supplies voltage to the protection modules and forwards the status of each individual arrester to the controller. You benefit from the reduced wiring costs and can implement surge protection quickly without errors.



### For Ex Zone 2

With the PLUGTRAB PT-IQ protective devices, it is possible for the first time to install protective devices with multi-stage monitoring and remote signaling directly in Ex Zone 2. The intrinsically safe protective circuits can be led up to Ex Zone 0.







### Special systems

Implement protection in the field directly at the measuring sensor with SURGETRAB screw connection modules.

### Selection guide

Explanation of the IEC categories		
LPZ zone	Test category for SPD corresponds to IEC 61643-21	Test class for SPD corresponds to IEC 61643-11
0/1	D1	I
1/2	C2	II
2/3	C1	III











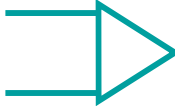























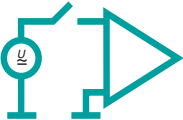

















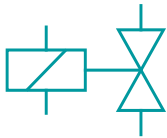

	DIN rail mounting
	Push-in connection
	Screw connection
	Cables
1)	Also available with screw connection technology



Data for fault analysis according to IEC 61508 is available on the Internet.



**Note**  
Products bearing this stamp (plug elements) can be tested with the CHECKMASTER.

Application	Installation properties
 Current loops 0(4) mA ... 20 mA	  1)   1) 
	   
	  1)   1) 
	   
Analog signal 0 V ... 10 V	  1)   1) 
	 9 Resistance-dependent measurement e.g., with Pt 100
 Digital input/ digital output	Common reference conductor: isolated from ground   1)   1) 
	Common reference conductor: directly grounded   1)   1) 
	Common reference conductor: isolated from ground   1)   1) 
	Common reference conductor: directly grounded   1)   1) 
 Digital output > 600 mA	Common reference conductor: isolated from ground   1)   1) 
	Common reference conductor: directly grounded   1)   1) 

	Overall width in mm	IEC category	Status display	Pluggable	Knife dis-connection	IQ function monitoring	Protected wires	Surge protective device (SPD)	Order No.	Page
	3.5	D1/C2/C1					2	TTC-3-1X2-24DC-PT	2907325	95
	6.2	D1/C2/C1	✓	✓	✓		2	TTC-6P-1X2-M-24DC-PT-I	2906750	92
	17.5	D1/C2/C1	✓	✓		✓	3	PT-IQ-1X2-24DC-PT	2801255	96
	> 17.5	D1/C2/C1					2	S-PT-1X2-24DC	2880668	101
	6.2	D1/C2/C1	✓	✓	✓		2	TTC-6P-1X2-M-EX-24DC-UT-I	2906824	128
	17.5	D1/C2/C1	✓	✓		✓	4	PT-IQ-2X2-EX-24DC-UT	2801513	129
	> 17.5	D1/C2/C1					2	S-PT-EX(I)-24DC	2880671	130
	3.5	D1/C2/C1					3	TTC-3-2X1-24DC-PT	2907326	109
	6.2	D1/C2/C1	✓	✓	✓		3	TTC-6P-2X1-M-24DC-PT-I	2906753	104
	17.5	D1/C2/C1	✓	✓		✓	3	PT-IQ-2X1-24DC-PT	2801247	110
	> 17.5	D1/C2/C1					4	S-PT-4-EX-24DC	2800036	118
	6.2	D1/C2/C1	✓	✓	✓		3	TTC-6P-2X1-M-EX-24DC-UT-I	2906825	133
	> 17.5	D1/C2/C1					4	S-PT-4-EX-24DC	2800036	118
	3.5	D1/C2/C1					2	TTC-3-1X2-24DC-PT	2907325	95
	6.2	D1/C2/C1	✓	✓			2	TTC-6P-1X2-12DC-PT-I	2908193	92
	17.5	D1/C2/C1	✓	✓		✓	2	PT-IQ-1X2-12DC-PT	2801253	96
	> 17.5	D1/C2/C1					2	S-PT-1X2-24DC	2880668	101
	6.2	D1/C2/C1	✓	✓	✓		2	TTC-6P-2-HC-M-24DC-PT-I	2906755	106
	> 17.5	D1/C2/C1					2	S-PT-EX-24DC	2800034	130
	6.2	D1/C2/C1	✓	✓	✓		3	TTC-6P-2X1-F-M-24DC-PT-I	2906794	105
	17.5	D1/C2/C1	✓	✓		✓	5	PT-IQ-4X1+F-24DC-PT	2801272	111
	> 17.5	D1/C2/C1					5	S-PT-4-EX-24DC	2800036	118
	3.5	D1/C2/C1					3	TTC-3-2X1-24DC-PT	2907326	109
	6.2	D1/C2/C1	✓	✓	✓		3	TTC-6P-2X1-M-24DC-PT-I	2906753	104
	17.5	D1/C2/C1	✓	✓		✓	5	PT-IQ-4X1-24DC-PT	2801271	111
	> 17.5	D1/C2/C1					5	S-PT-4-EX-24DC	2800036	118
	6.2	D1/C2/C1	✓	✓	✓		3	TTC-6P-2-HC-M-24DC-PT-I	2906755	106
	17.5	D1/C2/C1	✓	✓		✓	5	PT-IQ-4X1+F-24DC-PT	2801272	111
	> 17.5	D1/C2/C1					2	S-PT-EX-24DC	2800034	130
	17.5	D1/C2/C1	✓	✓		✓	5	PT-IQ-4X1-24DC-PT	2801271	111

# Surge protection and interference suppression filters

## Surge protection for MCR technology

### Protection of a 0(4) ... 20 mA current loop

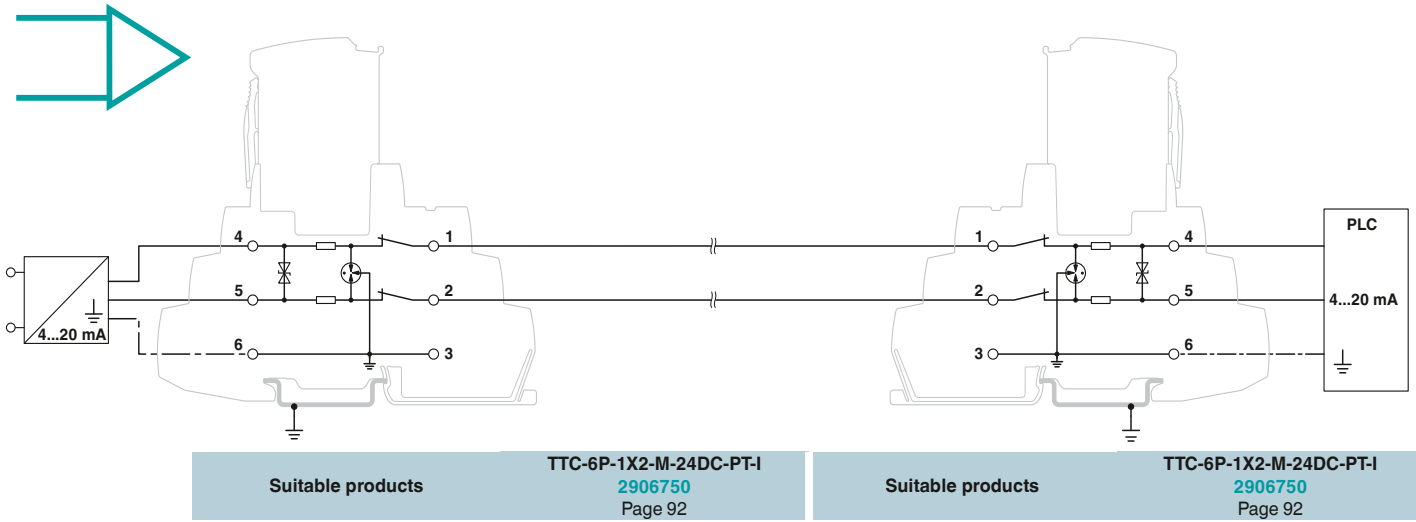

### Protection of a 0(4) ... 20 mA current loop, intrinsically safe circuits

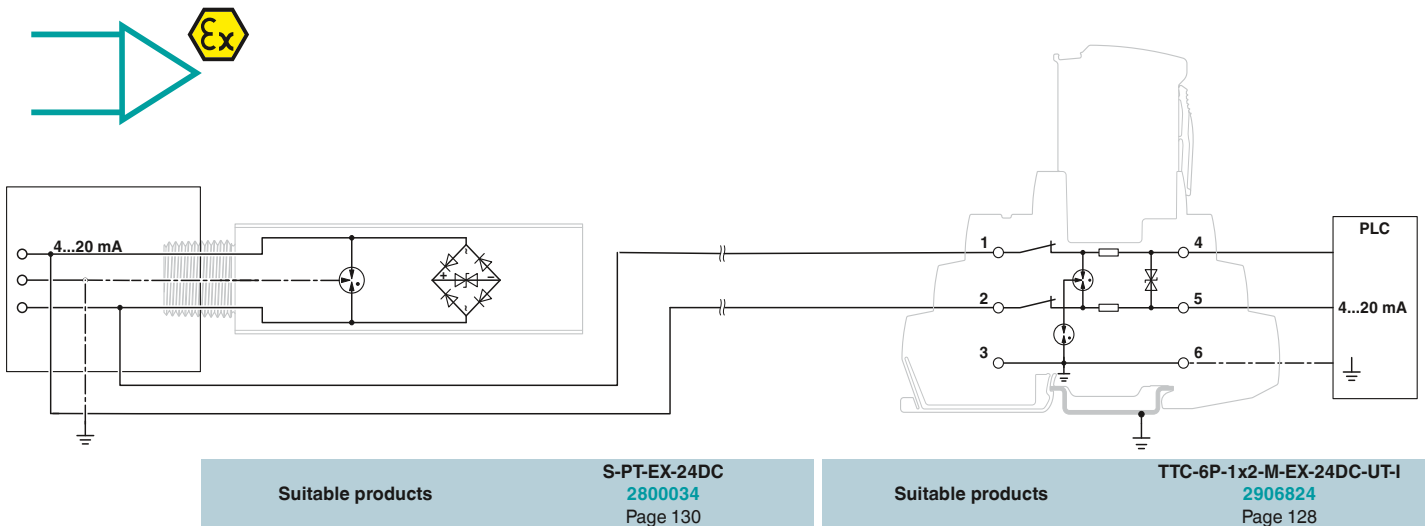

### Protection of a 0(4) ... 20 mA current loop and additional power supply

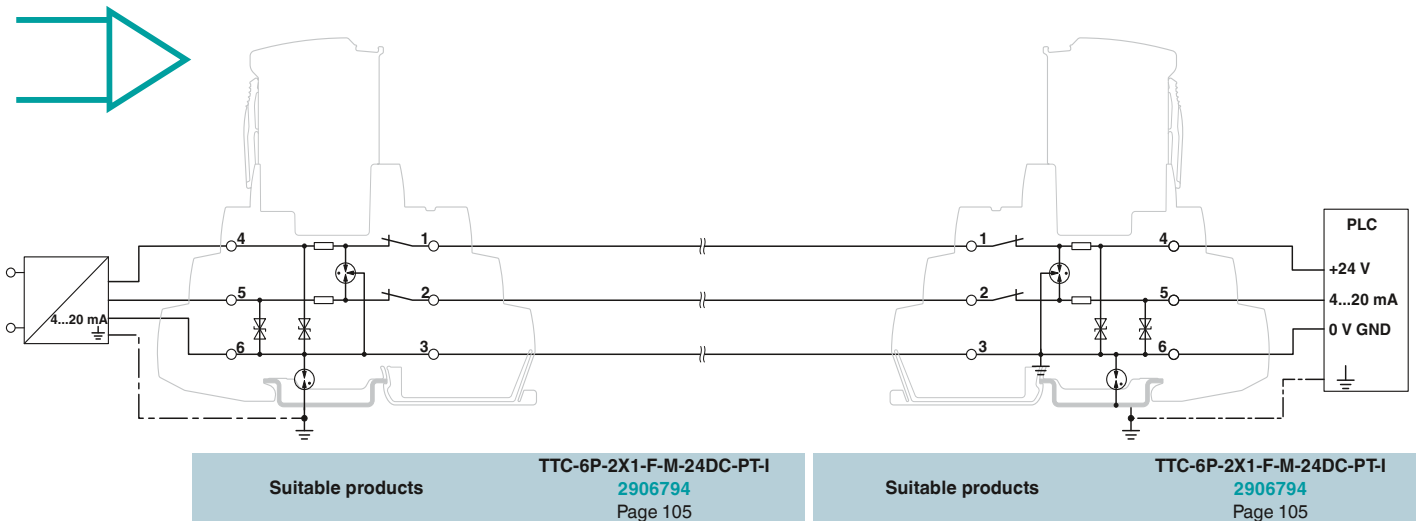

### Protection of a 0(4) ... 20 mA current loop

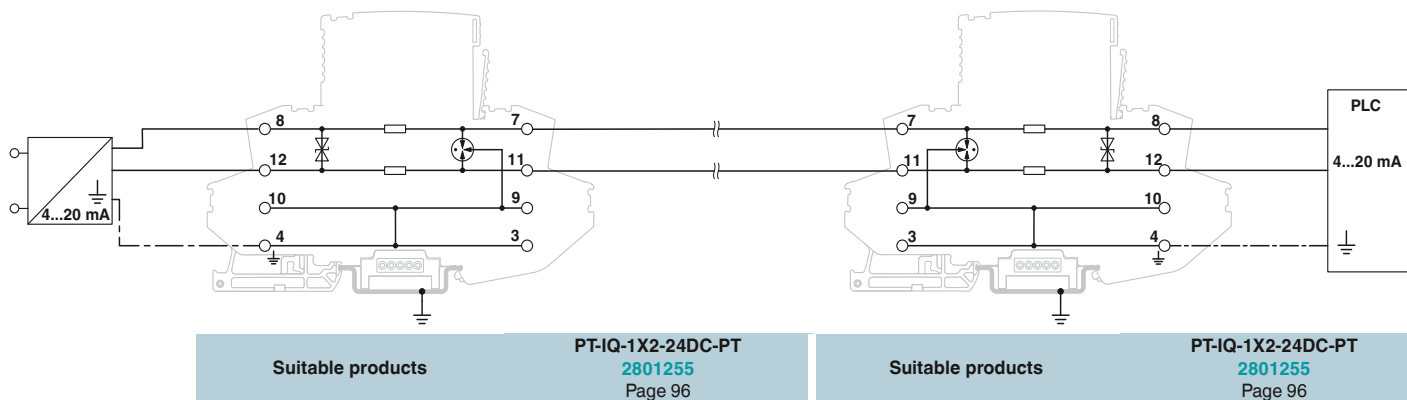
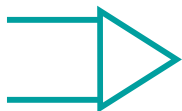

### Protection of a 0(4) ... 20 mA current loop, intrinsically safe circuits

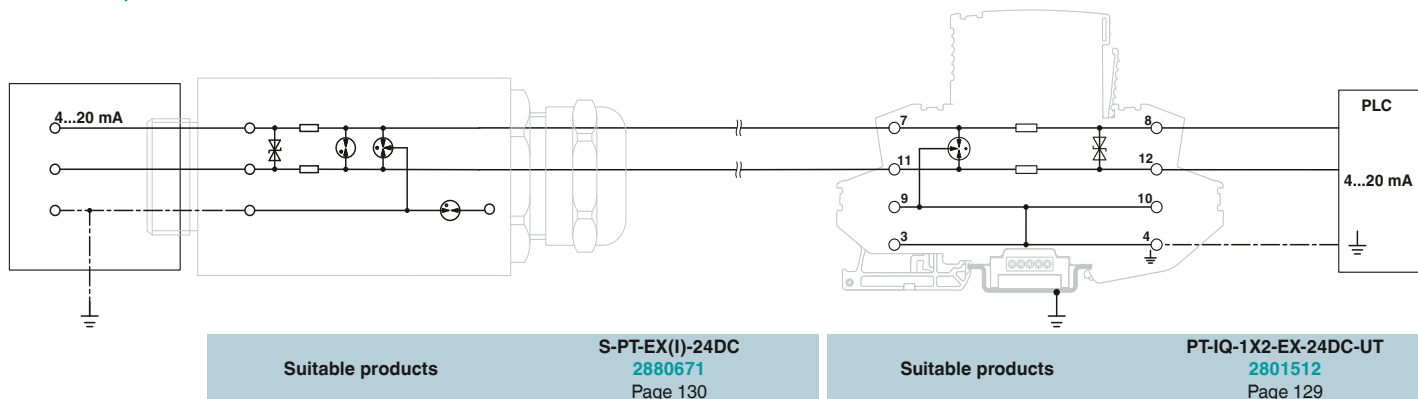

### Protection of a 0(4) ... 20 mA current loop and additional power supply

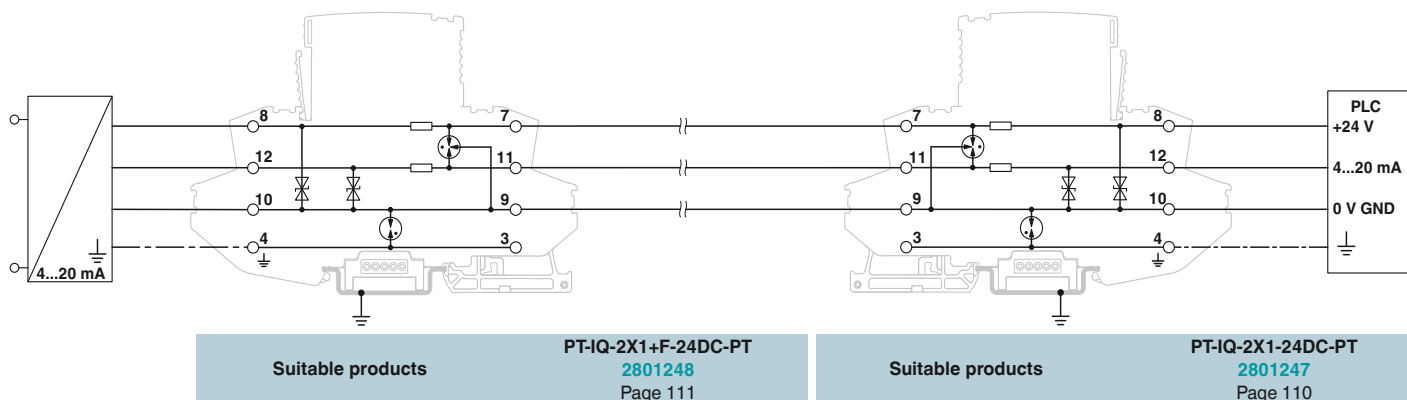
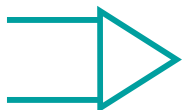

# Surge protection and interference suppression filters

## Surge protection for MCR technology

### Protection of a digital I/O (24 V), reference conductor not grounded

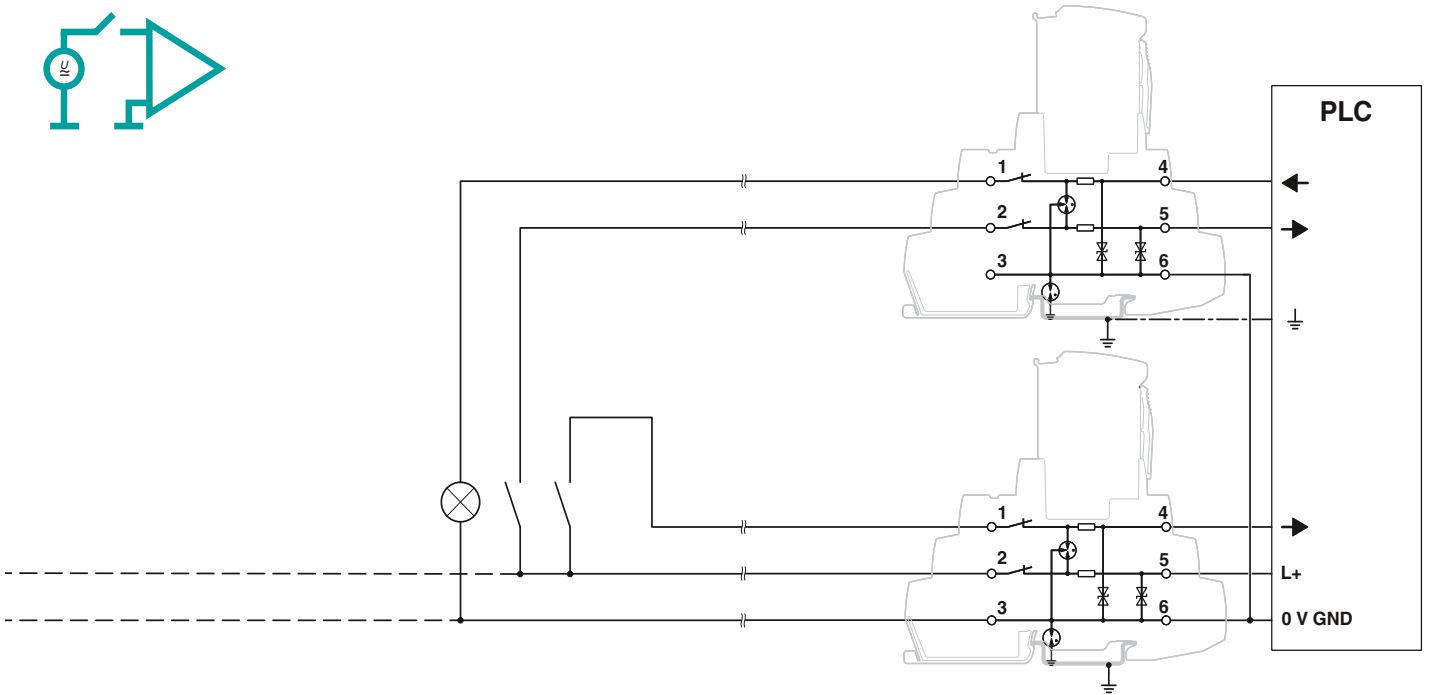
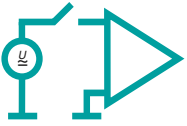

Suitable products

TTC-6P-2X1-F-M-24DC-PT-I  
2906794  
Page 105

### Protection of a digital I/O (24 V), reference conductor not grounded

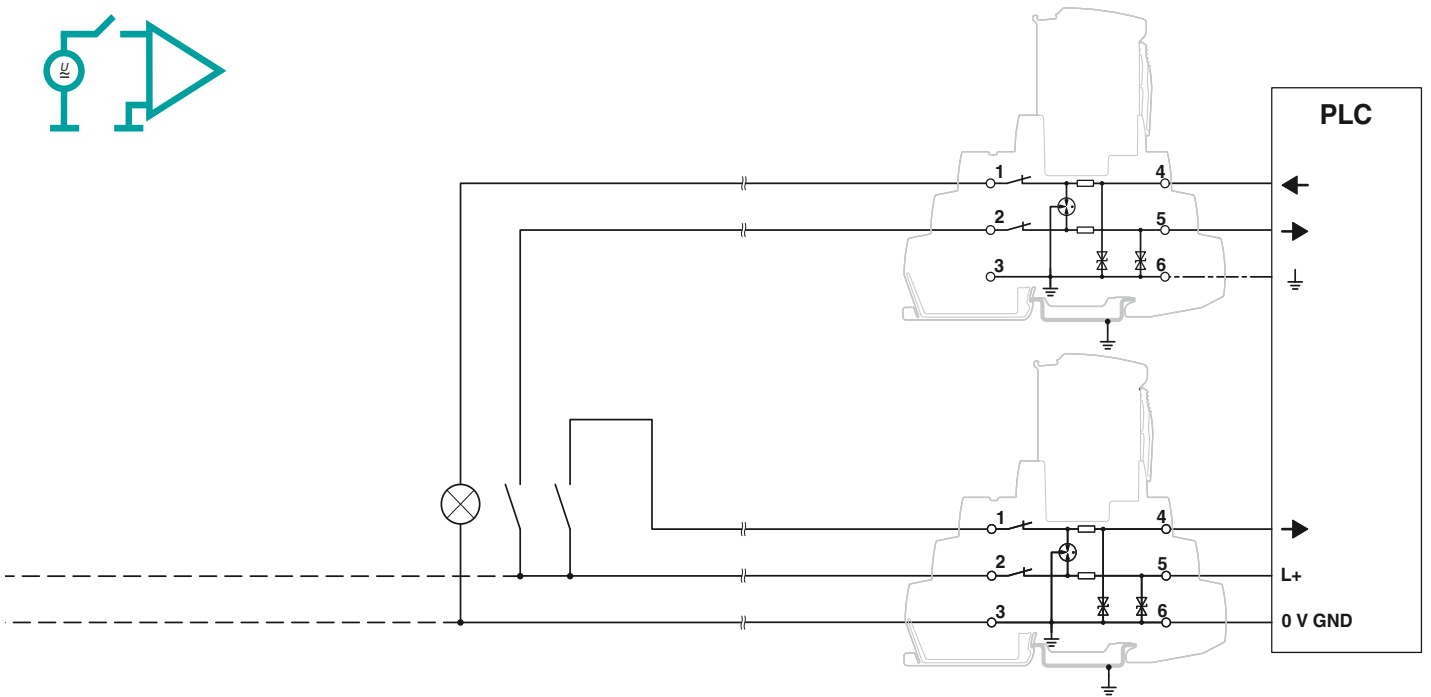
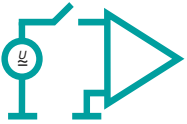

Suitable products

TTC-6P-2X1-M-24DC-I  
2906753  
Page 104

### Protection of a digital I/O (24 V), reference conductor not grounded

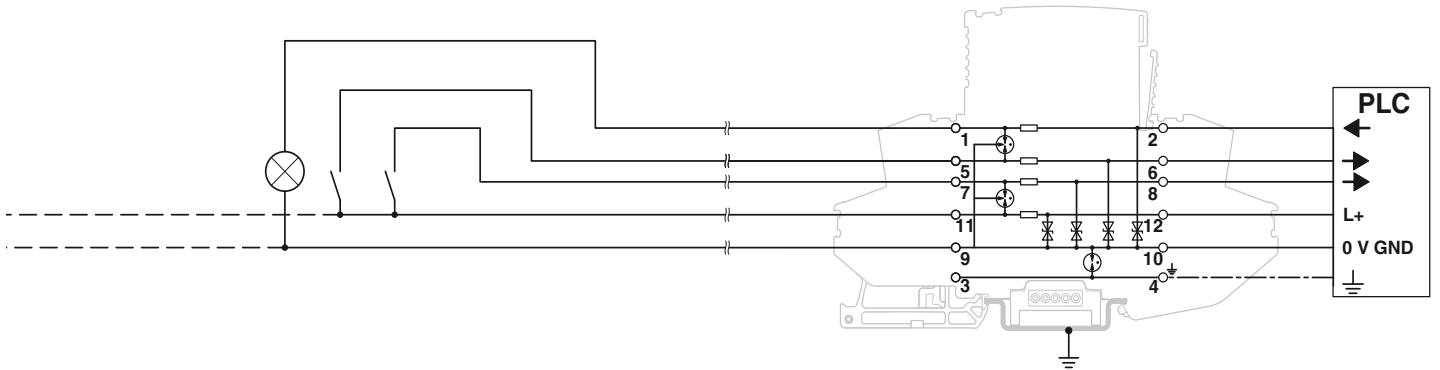
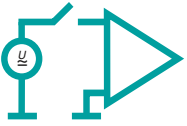

Suitable products **PT-IQ-4X1+F-24DC-PT**  
2801272  
Page 111

### Protection of a digital I/O (24 V), reference conductor not grounded

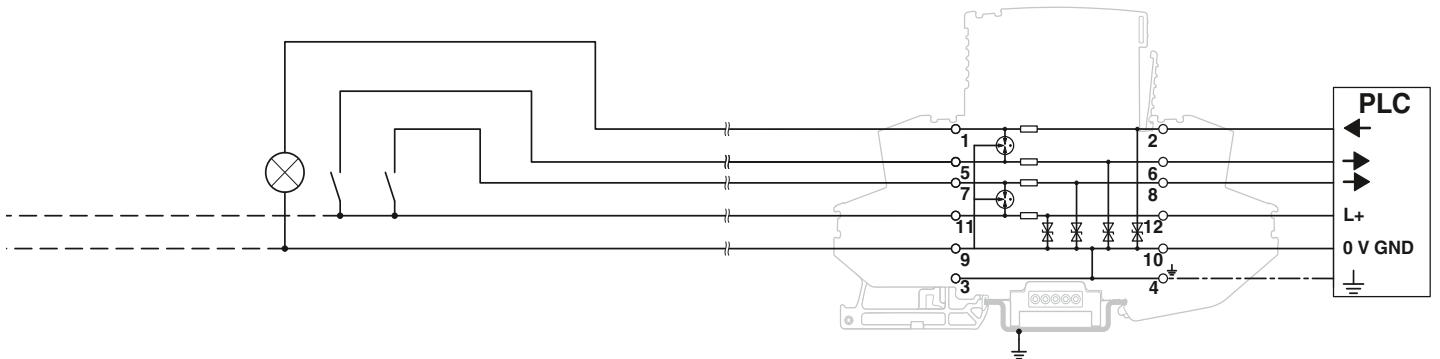
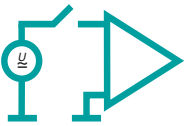

Suitable products **PT-IQ-4X1-24DC-PT**  
2801271  
Page 111

### Protection of a two-wire temperature measurement

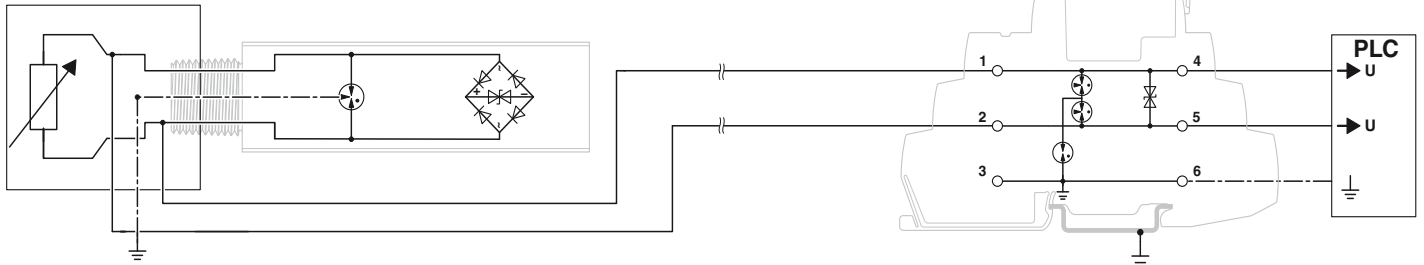
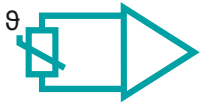

Suitable products

**S-PT-EX-24DC**  
2800034  
Page 130

Suitable products

**TTC-6P-2-HC-M-24DC-PT-I**  
2906755  
Page 106

### Protection of a four-wire temperature measurement

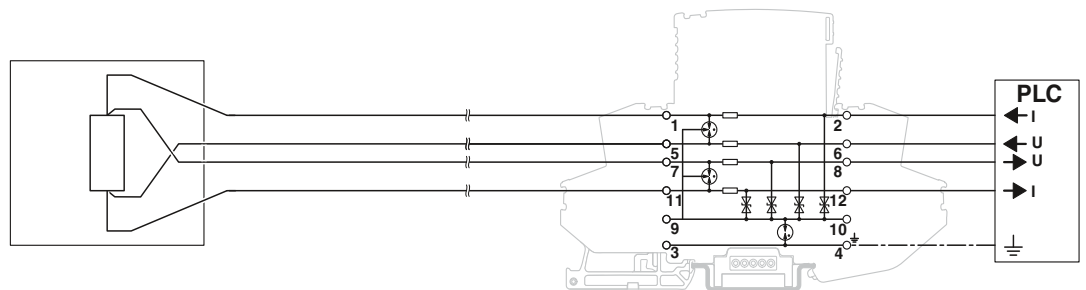
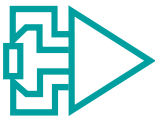

Suitable products

**PT-IQ-4X1+F-12DC-PT**  
2801272  
Page 111

Protection of a digital output (actuator)

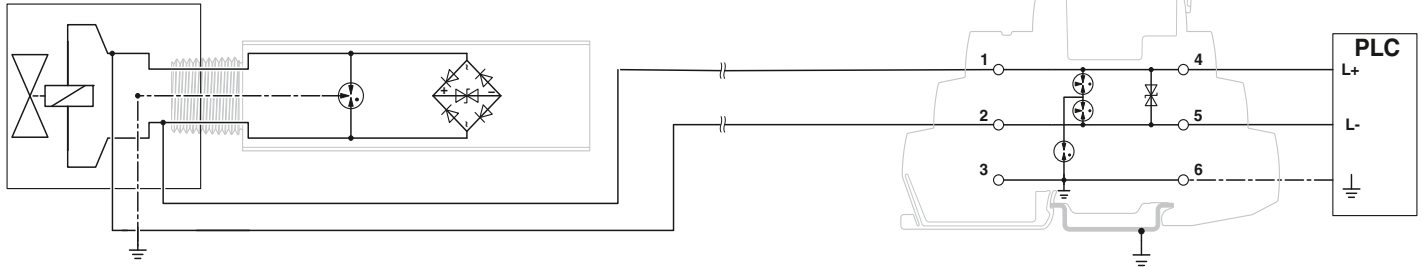
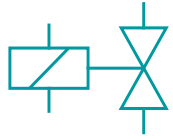

Suitable products

**S-PT-EX-24DC**  
[2800034](#)  
 Page 130

Suitable products

**TTC-6P-2-HC-M-24DC-PT-I**  
[2906755](#)  
 Page 106

# Surge protection and interference suppression filters

## Surge protection for MCR technology

### Current loops and analog signals TERMITRAB complete

- Pluggable surge protection
- Overall width of just 6.2 mm
- With Push-in or screw connection technology
- Impedance-neutral insertion and removal
- Coded connector versions
- With knife disconnection as an option
- Integrated mechanical status indicator
- Optional remote signaling module monitors up to 40 items, without additional wiring
- Plugs can be tested with CHECKMASTER 2

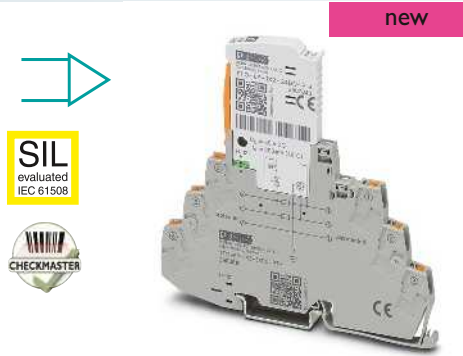

**Double wire (loop), floating, 3/6 connection grounded directly, e.g., for 4 ... 20 mA current loop**

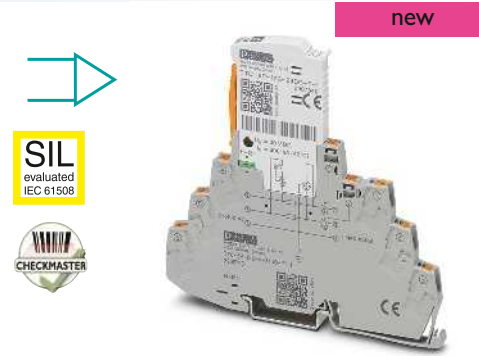

**Double wire (loop), floating, 3/6 connection grounded directly, with knife disconnection, e.g., for 4 ... 20 mA current loop**

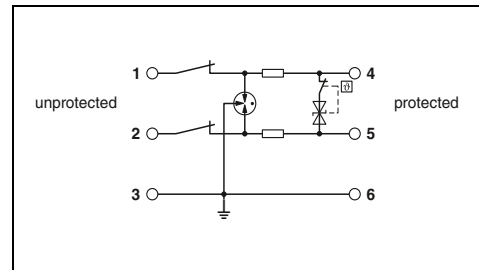
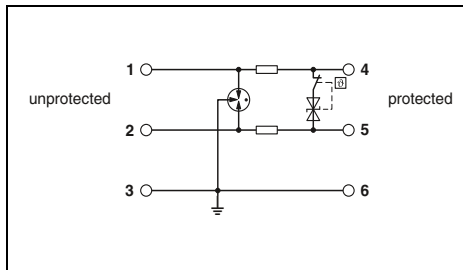

Electrical data	
IEC test classification/EN type	
Maximum continuous operating voltage $U_c$	
Rated current	
Pulse discharge current $I_{imp}$ (10/350) $\mu$ s	
Nominal discharge current $I_n$ (8/20) $\mu$ s	
Total discharge current $I_{total}$ (8/20) $\mu$ s	
Protection level $U_p$	
Cut-off frequency $f_g$ (3 dB)	
Resistance per path	
General data	
Dimensions W/H/D	
Connection data solid/stranded/AWG	
Temperature range	
Test standards	

Technical data			
... 12DC	... 24DC	... 48DC	
C1 / C2 / C3 / D1	C1 / C2 / C3 / D1	C1 / C2 / C3 / D1	
15 V DC	30 V DC	55.2 V DC	
600 mA (40°C)	600 mA (40°C)	160 mA (75°C)	
0.5 kA	0.5 kA	0.5 kA	
Core-Core / Core-Ground		5 kA / 5 kA	5 kA / 5 kA
		10 kA	10 kA
Core-Core		$\leq 25$ V (C3 - 25 A)	$\leq 50$ V (C3 - 25 A)
Core-Ground		$\leq 700$ V (C3 - 25 A)	$\leq 700$ V (C3 - 25 A)
Symmetrical in the 150 $\Omega$ system		typ. 420 kHz	typ. 940 kHz
		1.65 $\Omega$	1.65 $\Omega$
		6.2 mm / 105.8 mm / 100 mm	
		0.2...4 mm <sup>2</sup> / 0.2...2.5 mm <sup>2</sup> / 24 ... 12	
		-40 °C ... 85 °C	
		IEC 61643-21 / EN 61643-21	

Technical data			
... 24DC			
C1 / C2 / C3 / D1			
30 V DC			
600 mA (40°C)			
0.5 kA			
Core-Core / Core-Ground		5 kA / 5 kA	5 kA / 5 kA
		10 kA	10 kA
Core-Core		$\leq 50$ V (C3 - 25 A)	$\leq 85$ V (C3 - 25 A)
Core-Ground		$\leq 700$ V (C3 - 25 A)	$\leq 700$ V (C3 - 25 A)
Symmetrical in the 150 $\Omega$ system		typ. 940 kHz	typ. 1.8 MHz
		1.65 $\Omega$	1.65 $\Omega$
		6.2 mm / 105.8 mm / 100 mm	
		0.2...4 mm <sup>2</sup> / 0.2...2.5 mm <sup>2</sup> / 24 ... 12	
		-40 °C ... 85 °C	
		IEC 61643-21 / EN 61643-21	

Description		Voltage $U_N$
<b>TERMITRAB complete, with screw connection technology</b>		
		12 V DC
		24 V DC
		48 V DC
<b>TERMITRAB complete, with Push-in connection technology</b>		
		12 V DC
		24 V DC
		48 V DC

Ordering data			
Type	Order No.	Pcs./Pkt.	
TTC-6P-1X2-12DC-UT-I	2908192	1	
TTC-6P-1X2-24DC-UT-I	2906809	1	
TTC-6P-1X2-48DC-UT-I	2908194	1	
TTC-6P-1X2-12DC-PT-I	2908193	1	
TTC-6P-1X2-24DC-PT-I	2906815	1	
TTC-6P-1X2-48DC-PT-I	2908195	1	

Ordering data			
Type	Order No.	Pcs./Pkt.	
TTC-6P-1X2-M-24DC-UT-I	2906738	1	
TTC-6P-1X2-M-24DC-PT-I	2906750	1	

Remote signaling set	
Screw connection technology	
Push-in connection technology	

Accessories			
TTC-6-FMRS-UT	2907810	1	
TTC-6-FMRS-PT	2907811	1	

Accessories			
TTC-6-FMRS-UT	2907810	1	
TTC-6-FMRS-PT	2907811	1	

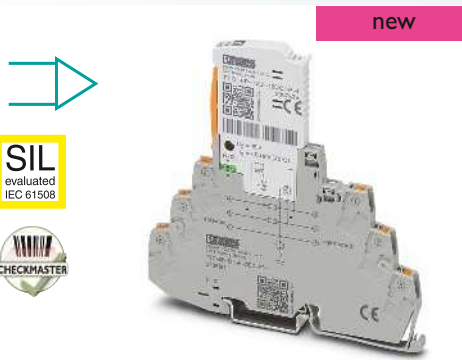

**Double wire (loop), floating, 3/6 connection grounded via gas-filled surge arrester, e.g., for 4 ... 20 mA current loop**

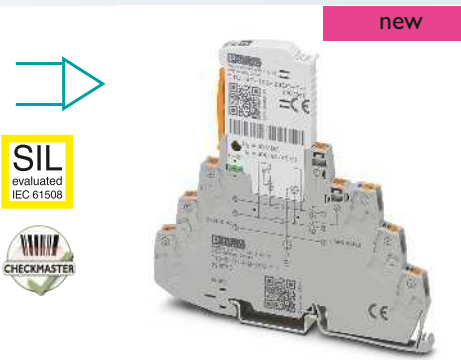

**Double wire (loop), floating, 3/6 connection grounded via gas-filled surge arrester, with knife disconnection, e.g., for 4 ... 20 mA current loop**

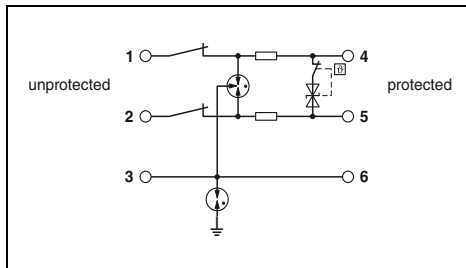
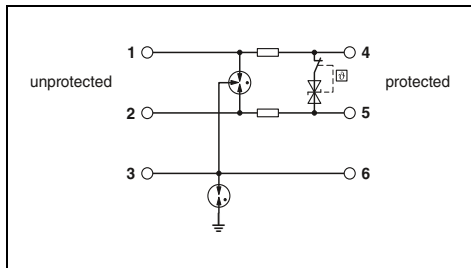

Technical data	
... 12DC	... 48DC
C1 / C2 / C3 / D1	C1 / C2 / C3 / D1
15 V DC	55.2 V DC
600 mA (40°C)	160 mA (75°C)
0.5 kA	0.5 kA
5 kA / 5 kA	5 kA / 5 kA
10 kA	10 kA
≤ 25 V (C3 - 25 A)	≤ 85 V (C3 - 25 A)
≤ 1.3 kV (C3 - 25 A)	≤ 1.3 kV (C3 - 25 A)
typ. 420 kHz	typ. 1.8 MHz
1.65 Ω	1.65 Ω
6.2 mm / 105.8 mm / 100 mm	
0.2...4 mm <sup>2</sup> / 0.2...2.5 mm <sup>2</sup> / 24 ... 12	
-40 °C ... 85 °C	
IEC 61643-21 / EN 61643-21	

Technical data	
... 24DC	
C1 / C2 / C3 / D1	
30 V DC	
600 mA (40°C)	
0.5 kA	
5 kA / 5 kA	
10 kA	
≤ 50 V (C3 - 25 A)	
≤ 1.3 kV (C3 - 25 A)	
typ. 940 kHz	
1.65 Ω	
6.2 mm / 105.8 mm / 100 mm	
0.2...4 mm <sup>2</sup> / 0.2...2.5 mm <sup>2</sup> / 24 ... 12	
-40 °C ... 85 °C	
IEC 61643-21 / EN 61643-21	

Ordering data		
Type	Order No.	Pcs./Pkt.
TTC-6P-1X2-F-12DC-UT-I	2908196	1
TTC-6P-1X2-F-48DC-UT-I	2908199	1
TTC-6P-1X2-F-12DC-PT-I	2908198	1
TTC-6P-1X2-F-48DC-PT-I	2908200	1

Ordering data		
Type	Order No.	Pcs./Pkt.
TTC-6P-1X2-F-M-24DC-UT-I	2906781	1
TTC-6P-1X2-F-M-24DC-PT-I	2906790	1

Accessories		
Type	Order No.	Pcs./Pkt.
TTC-6-FMRS-UT	2907810	1
TTC-6-FMRS-PT	2907811	1

Accessories		
Type	Order No.	Pcs./Pkt.
TTC-6-FMRS-UT	2907810	1
TTC-6-FMRS-PT	2907811	1

# Surge protection and interference suppression filters

## Surge protection for MCR technology

### Current loops and analog signals TERMITRAB complete

- Overall width of just 6.2 mm
- With Push-in or screw connection technology
- With integrated mechanical status indicator and knife disconnection as an option
- Optional remote signaling module monitors up to 40 items, without additional wiring

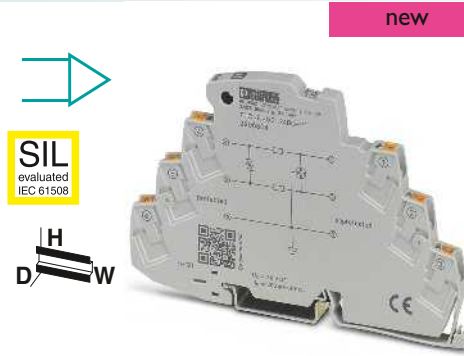

Double wire (loop), floating, 3/6 connection grounded directly, e.g., for 4 ... 20 mA current loop

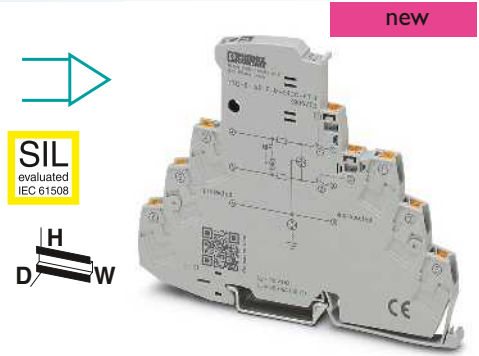

Double wire (loop), floating, 3/6 connection grounded via gas-filled surge arrester, with knife disconnection, e.g., for 4 ... 20 mA current loop

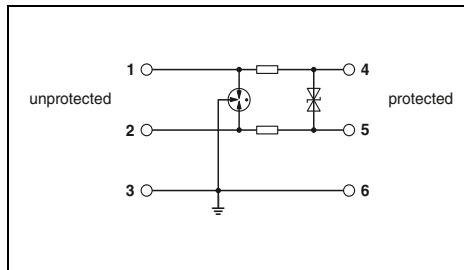

#### Technical data

Electrical data	
IEC test classification/EN type	C1 / C2 / C3 / D1
Maximum continuous operating voltage $U_C$	30 V DC
Rated current	600 mA (40°C)
Pulse discharge current $I_{imp}$ (10/350) $\mu$ s	0.5 kA
Nominal discharge current $I_n$ (8/20) $\mu$ s	
	Core-Core / Core-Ground
Total discharge current $I_{total}$ (8/20) $\mu$ s	5 kA / 5 kA
Protection level $U_p$	10 kA
	Core-Core
	$\leq 50$ V (C3 - 25 A)
	Core-Ground
	$\leq 700$ V (C3 - 25 A)
Cut-off frequency $f_g$ (3 dB)	
	Symmetrical in the 150 $\Omega$ system
Resistance per path	typ. 940 kHz
General data	1.65 $\Omega$
Dimensions W/H/D	6.2 mm / 105.8 mm / 69.5 mm
Connection data solid/stranded/AWG	0.2...4 mm <sup>2</sup> / 0.2...2.5 mm <sup>2</sup> / 24 ... 12
Temperature range	-40 °C ... 85 °C
Test standards	IEC 61643-21 / EN 61643-21

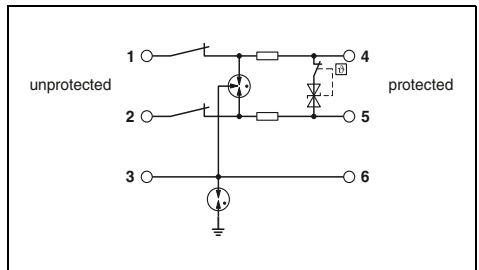

#### Technical data

Electrical data	
IEC test classification/EN type	C1 / C2 / C3 / D1
Maximum continuous operating voltage $U_C$	30 V DC
Rated current	600 mA (40°C)
Pulse discharge current $I_{imp}$ (10/350) $\mu$ s	0.5 kA
Nominal discharge current $I_n$ (8/20) $\mu$ s	
	Core-Core / Core-Ground
Total discharge current $I_{total}$ (8/20) $\mu$ s	5 kA / 5 kA
Protection level $U_p$	10 kA
	Core-Core
	$\leq 50$ V (C3 - 25 A)
	Core-Ground
	$\leq 1.3$ kV (C3 - 25 A)
Cut-off frequency $f_g$ (3 dB)	
	Symmetrical in the 150 $\Omega$ system
Resistance per path	typ. 940 kHz
General data	1.65 $\Omega$
Dimensions W/H/D	6.2 mm / 105.8 mm / 83.5 mm
Connection data solid/stranded/AWG	0.2...4 mm <sup>2</sup> / 0.2...2.5 mm <sup>2</sup> / 24 ... 12
Temperature range	-40 °C ... 85 °C
Test standards	IEC 61643-21 / EN 61643-21

#### Ordering data

Description	Voltage $U_N$
<b>TERMITRAB complete</b> , with screw connection technology	
Without status indicator	24 V DC
With status indicator	24 V DC
<b>TERMITRAB complete</b> , with Push-in connection technology	
Without status indicator	24 V DC
With status indicator	24 V DC

Type	Order No.	Pcs./Pkt.
TTC-6-1X2-24DC-UT	2906798	1
TTC-6-1X2-M-24DC-UT-I	2906713	1
TTC-6-1X2-24DC-PT	2906804	1
TTC-6-1X2-M-24DC-PT-I	2906726	1

#### Ordering data

Type	Order No.	Pcs./Pkt.
TTC-6-1X2-F-M-24DC-UT-I	2906764	1
TTC-6-1X2-F-M-24DC-PT-I	2906772	1

#### Accessories

Remote signaling set
Screw connection technology
Push-in connection technology

Type	Order No.	Pcs./Pkt.
TTC-6-FMRS-UT	2907810	1
TTC-6-FMRS-PT	2907811	1

#### Accessories

Type	Order No.	Pcs./Pkt.
TTC-6-FMRS-UT	2907810	1
TTC-6-FMRS-PT	2907811	1

**Current loops and analog signals  
TERMITRAB complete**

- Overall width of just 3.5 mm
- With Push-in connection technology

new

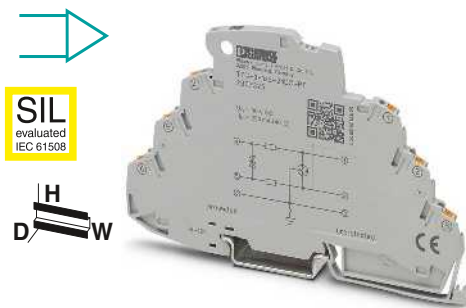

**Double wire (loop), floating,  
e.g., for 4 ... 20 mA current loops**

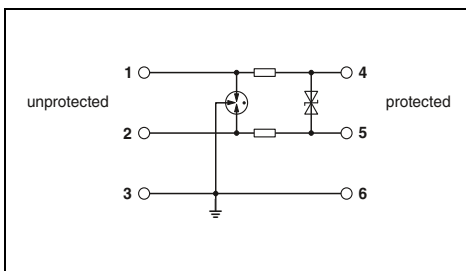

**Technical data**

<b>Electrical data</b>		
IEC test classification/EN type		C1 / C2 / C3 / D1
Maximum continuous operating voltage $U_C$		30 V DC
Rated current		250 mA (70°C)
Pulse discharge current $I_{imp}$ (10/350) $\mu$ s		0.5 kA
Nominal discharge current $I_n$ (8/20) $\mu$ s		
	Core-Core / Core-Ground	5 kA / 5 kA
Total discharge current $I_{total}$ (8/20) $\mu$ s		10 kA
Protection level $U_p$		
	Core-Core	$\leq 45$ V (C3 - 30 A)
	Core-Ground	$\leq 1000$ V (C3 - 100 A)
Cut-off frequency $f_g$ (3 dB)		typ. 2.4 MHz
	Symmetrical in the 150 $\Omega$ system	2.2 $\Omega$
Resistance per path		
<b>General data</b>		
Dimensions W/H/D		3.5 mm / 106 mm / 69.5 mm
Connection data solid/stranded/AWG		0.2...1.5 mm <sup>2</sup> / 0.2...1.5 mm <sup>2</sup> / 24 ... 16
Temperature range		-40 °C ... 85 °C
Test standards		IEC 61643-21 / EN 61643-21

**Ordering data**

Description	Voltage $U_N$	Type	Order No.	Pcs./Pkt.
<b>TERMITRAB complete</b> , with Push-in connection technology				
	24 V DC	TTC-3-1X2-24DC-PT	2907325	1

**Accessories**

<b>End cover</b>		TTC-3-LCP	2908843	1
------------------	--	-----------	---------	---

# Surge protection and interference suppression filters

## Surge protection for MCR technology

### Current loops and analog signals PLUGTRAB PT-IQ

- Multi-stage status monitoring
- Group message via supply and remote signaling module
- Multi-stage, floating remote signaling
- System supplied via DIN rail bus
- Up to 28 protection modules per supply module
- Maximum ease of maintenance thanks to the two-piece design
- Plugs are coded
- Impedance-neutral disconnection of plug for maintenance purposes
- PT-IQ... base element with Push-in or screw connection technology
- Base element remains an integral part of the installation
- Corresponding replacement plugs can be found on our website



Supply and remote signaling module



Double wire (loop), floating, connection 9/10 grounded directly, e.g., for 4 ... 20 mA current loop

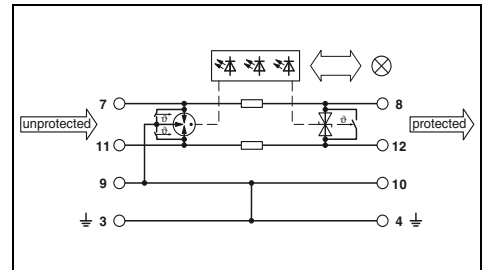
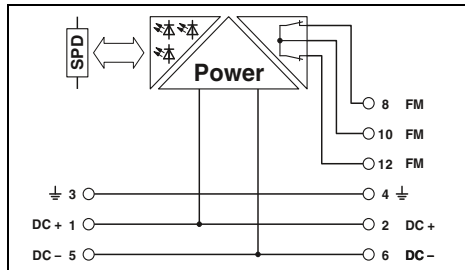

#### Technical data

Electrical data	
IEC test classification/EN type	
Maximum continuous operating voltage $U_c$	-
Rated current	-
Pulse discharge current $I_{imp}$ (10/350) $\mu$ s	-
Nominal discharge current $I_n$ (8/20) $\mu$ s	-
Total discharge current $I_{total}$ (8/20) $\mu$ s	Core-Core / Core-Ground - / -
Protection level $U_p$	Core-Core -
	Core-Ground -
Resistance per path	-
General data	
PT-IQ...UT dimensions W/H/D	17.7 mm / 91.1 mm / 77.5 mm
PT-IQ...PT dimensions W/H/D	17.7 mm / 109.3 mm / 77.5 mm
Connection data solid/stranded/AWG	0.2...4 mm <sup>2</sup> / 0.2...2.5 mm <sup>2</sup> / 24 ... 12
Temperature range	-40 °C ... 70 °C
Test standards	EN 61000-6-2 / EN 61000-6-3 / EN 60950-1 / EN 60079-0 / EN 60079-11 / EN 60079-15
Remote indication contact	2x N/C contacts
Connection data solid/stranded/AWG	0.2...4 mm <sup>2</sup> / 0.2...2.5 mm <sup>2</sup> / 24 ... 14
Max. operating voltage	30 V AC (50/60 Hz, non-Ex) / 50 V DC (non-Ex)
Max. operating current	1 A (up to 50°C, non-Ex)

#### Technical data

... 5DC	... 12DC	... 24DC	... 48DC
C1 / C2 / C3 / D1	C1 / C2 / C3 / D1	C1 / C2 / C3 / D1	C1 / C2 / C3 / D1
6 V DC / 4 V AC	15 V DC / 10 V AC	30 V DC / 21 V AC	53 V DC / 37 V AC
1000 mA (40°C)	1000 mA (40°C)	1000 mA (40°C)	300 mA
2.5 kA	2.5 kA	2.5 kA	2.5 kA
10 kA / 10 kA	10 kA / 10 kA	10 kA / 10 kA	10 kA / 10 kA
20 kA	20 kA	20 kA	20 kA
$\leq 25$ V (C3 - 25 A)	$\leq 35$ V (C3 - 25 A)	$\leq 55$ V (C3 - 25 A)	$\leq 90$ V (C3 - 25 A)
$\leq 700$ V (C3 - 25 A)	$\leq 700$ V (C3 - 25 A)	$\leq 700$ V (C3 - 25 A)	$\leq 700$ V (C3 - 25 A)
1.2 $\Omega$	1.2 $\Omega$	1.2 $\Omega$	1.2 $\Omega$
	17.7 mm / 91.1 mm / 77.5 mm		
	17.7 mm / 109.3 mm / 77.5 mm		
	0.2...4 mm <sup>2</sup> / 0.2...2.5 mm <sup>2</sup> / 24 ... 12		
	-40 °C ... 70 °C		
	IEC 61643-21 / EN 61643-21 / EN 61000-6-3 / EN 61000-6-2		
	Via TBUS		
	- mm <sup>2</sup> / - mm <sup>2</sup> / -		

#### Ordering data

Description	Voltage $U_N$	Type	Order No.	Pcs./Pkt.
<b>PLUGTRAB</b> , supply and remote signaling module				
Screw connection technology		<b>PT-IQ-PTB-UT</b>	<b>2800768</b>	1
Push-in connection technology		<b>PT-IQ-PTB-PT</b>	<b>2801296</b>	1
<b>PLUGTRAB</b> , with screw connection technology	5 V DC 12 V DC 24 V DC 48 V DC			
<b>PLUGTRAB</b> , with Push-in connection technology	5 V DC 12 V DC 24 V DC 48 V DC			

#### Ordering data

Type	Order No.	Pcs./Pkt.
<b>PT-IQ-1X2-5DC-UT</b>	<b>2800791</b>	1
<b>PT-IQ-1X2-12DC-UT</b>	<b>2800793</b>	1
<b>PT-IQ-1X2-24DC-UT</b>	<b>2800976</b>	1
<b>PT-IQ-1X2-48DC-UT</b>	<b>2800978</b>	1
<b>PT-IQ-1X2-5DC-PT</b>	<b>2801251</b>	1
<b>PT-IQ-1X2-12DC-PT</b>	<b>2801253</b>	1
<b>PT-IQ-1X2-24DC-PT</b>	<b>2801255</b>	1
<b>PT-IQ-1X2-48DC-PT</b>	<b>2801257</b>	1



SIL  
evaluated  
IEC 61508



Double wire (loop), floating, connection 9/10 grounded via gas-filled surge arrester, e.g., for 4 ... 20 mA current loop



SIL  
evaluated  
IEC 61508



2 double wires (loops), floating, connection 9/10 grounded directly, e.g., for 4 ... 20 mA current loop



SIL  
evaluated  
IEC 61508



2 double wires (loops), floating, connection 9/10 grounded via gas-filled surge arrester, e.g., for 4 ... 20 mA current loop

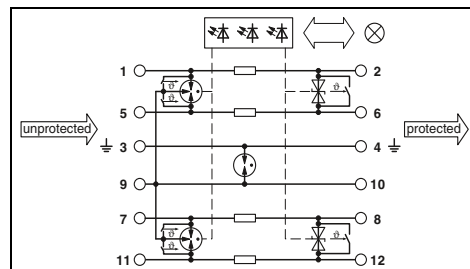
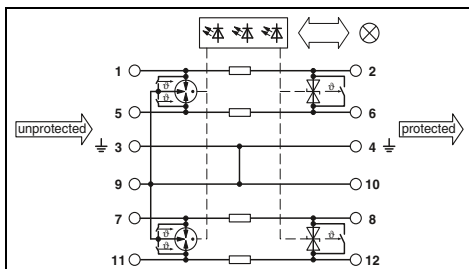
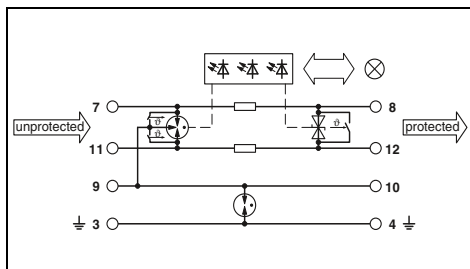

Technical data			
... 5DC	... 12DC	... 24DC	... 48DC
C1 / C2 / C3 / D1	C1 / C2 / C3 / D1	C1 / C2 / C3 / D1	C1 / C2 / C3 / D1
6 V DC / 4 V AC	15 V DC / 10 V AC	30 V DC / 21 V AC	53 V DC / 37 V AC
1000 mA (40°C)	1000 mA (40°C)	1000 mA (40°C)	300 mA
2.5 kA	2.5 kA	2.5 kA	2.5 kA
10 kA / 10 kA	10 kA / 10 kA	10 kA / 10 kA	10 kA / 10 kA
20 kA	20 kA	20 kA	20 kA
≤ 25 V (C3 - 25 A)	≤ 35 V (C3 - 25 A)	≤ 55 V (C3 - 25 A)	≤ 90 V (C3 - 25 A)
≤ 1000 V (C3 - 25 A)	≤ 1000 V (C3 - 25 A)	≤ 1000 V (C3 - 25 A)	≤ 1000 V (C3 - 25 A)
1.2 Ω	1.2 Ω	1.2 Ω	1.2 Ω

Technical data			
... 5DC	... 12DC	... 24DC	... 48DC
C1 / C2 / C3 / D1	C1 / C2 / C3 / D1	C1 / C2 / C3 / D1	C1 / C2 / C3 / D1
6 V DC / 4 V AC	15 V DC / 10 V AC	30 V DC / 21 V AC	53 V DC / 37 V AC
700 mA (50 °C)	700 mA (50 °C)	700 mA (50 °C)	300 mA
2.5 kA	2.5 kA	2.5 kA	2.5 kA
10 kA / 10 kA	10 kA / 10 kA	10 kA / 10 kA	10 kA / 10 kA
20 kA	20 kA	20 kA	20 kA
≤ 25 V (C3 - 25 A)	≤ 35 V (C3 - 25 A)	≤ 55 V (C3 - 25 A)	≤ 90 V (C3 - 25 A)
≤ 700 V (C3 - 25 A)	≤ 700 V (C3 - 25 A)	≤ 700 V (C3 - 25 A)	≤ 700 V (C3 - 25 A)
1.2 Ω	1.2 Ω	1.2 Ω	1.2 Ω

Technical data			
... 5DC	... 12DC	... 24DC	... 48DC
C1 / C2 / C3 / D1	C1 / C2 / C3 / D1	C1 / C2 / C3 / D1	C1 / C2 / C3 / D1
6 V DC / 4 V AC	15 V DC / 10 V AC	30 V DC / 21 V AC	53 V DC / 37 V AC
700 mA (50 °C)	700 mA (50 °C)	700 mA (50 °C)	300 mA
2.5 kA	2.5 kA	2.5 kA	2.5 kA
10 kA / 10 kA	10 kA / 10 kA	10 kA / 10 kA	10 kA / 10 kA
20 kA	20 kA	20 kA	20 kA
≤ 25 V (C3 - 25 A)	≤ 35 V (C3 - 25 A)	≤ 55 V (C3 - 25 A)	≤ 90 V (C3 - 25 A)
≤ 1000 V (C3 - 25 A)	≤ 1000 V (C3 - 25 A)	≤ 1000 V (C3 - 25 A)	≤ 1000 V (C3 - 25 A)
1.2 Ω	1.2 Ω	1.2 Ω	1.2 Ω

17.7 mm / 91.1 mm / 77.5 mm
17.7 mm / 109.3 mm / 77.5 mm
0.2...4 mm <sup>2</sup> / 0.2...2.5 mm <sup>2</sup> / 24 ... 12
-40 °C ... 70 °C
IEC 61643-21 / EN 61643-21 / EN 61000-6-3 / EN 61000-6-2
Via TBUS
- mm <sup>2</sup> / - mm <sup>2</sup> / -

17.7 mm / 91.1 mm / 77.5 mm
17.7 mm / 109.3 mm / 77.5 mm
0.2...4 mm <sup>2</sup> / 0.2...2.5 mm <sup>2</sup> / 24 ... 12
-40 °C ... 70 °C
IEC 61643-21 / EN 61643-21 / EN 61000-6-3 / EN 61000-6-2
Via TBUS
- mm <sup>2</sup> / - mm <sup>2</sup> / -

17.7 mm / 91.1 mm / 77.5 mm
17.7 mm / 109.3 mm / 77.5 mm
0.2...4 mm <sup>2</sup> / 0.2...2.5 mm <sup>2</sup> / 24 ... 12
-40 °C ... 70 °C
IEC 61643-21 / EN 61643-21 / EN 61000-6-3 / EN 61000-6-2
Via TBUS
- mm <sup>2</sup> / - mm <sup>2</sup> / -

Ordering data		
Type	Order No.	Pcs./Pkt.
PT-IQ-1X2+F-5DC-UT	2800792	1
PT-IQ-1X2+F-12DC-UT	2800975	1
PT-IQ-1X2+F-24DC-UT	2800977	1
PT-IQ-1X2+F-48DC-UT	2800979	1
PT-IQ-1X2+F-5DC-PT	2801252	1
PT-IQ-1X2+F-12DC-PT	2801254	1
PT-IQ-1X2+F-24DC-PT	2801256	1
PT-IQ-1X2+F-48DC-PT	2801258	1

Ordering data		
Type	Order No.	Pcs./Pkt.
PT-IQ-2X2-5DC-UT	2800807	1
PT-IQ-2X2-12DC-UT	2800984	1
PT-IQ-2X2-24DC-UT	2800980	1
PT-IQ-2X2-48DC-UT	2800986	1
PT-IQ-2X2-5DC-PT	2801259	1
PT-IQ-2X2-12DC-PT	2801261	1
PT-IQ-2X2-24DC-PT	2801263	1
PT-IQ-2X2-48DC-PT	2801265	1

Ordering data		
Type	Order No.	Pcs./Pkt.
PT-IQ-2X2+F-5DC-UT	2800809	1
PT-IQ-2X2+F-12DC-UT	2800985	1
PT-IQ-2X2+F-24DC-UT	2800981	1
PT-IQ-2X2+F-48DC-UT	2800987	1
PT-IQ-2X2+F-5DC-PT	2801260	1
PT-IQ-2X2+F-12DC-PT	2801262	1
PT-IQ-2X2+F-24DC-PT	2801264	1
PT-IQ-2X2+F-48DC-PT	2801266	1

# Surge protection and interference suppression filters

## Surge protection for MCR technology

### Current loops and analog signals PLUGTRAB PT

- Consistently pluggable signal circuit protection
- Maximum ease of maintenance thanks to the two-piece design
- Base element remains an integral part of the installation
- Impedance-neutral disconnection of plug for test and maintenance purposes
- Plugs can be checked with CHECKMASTER

**\* Note:**

Various grounding options for the base elements:

**PT .x.-BE** connections 9/10 (GND) directly connected to the mounting foot.

**PT .x.+F-BE** connections 9/10 (GND) connected to the mounting foot via a gas-filled surge arrester.



Double wire (loop), floating, e.g., for 4 ... 20 mA current loops

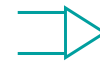

Double wire (loop), floating, e.g., for 4 ... 20 mA current loops

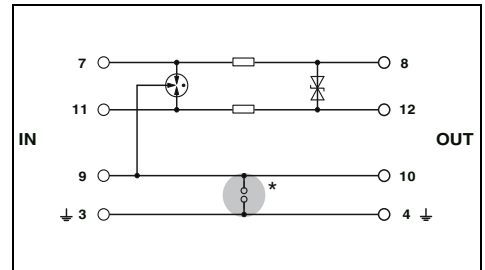
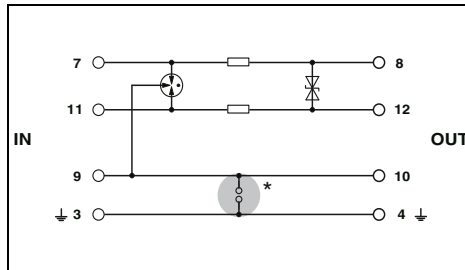

#### Technical data

Electrical data	Technical data			
	... 5DC C1 / C2 / C3 / D1	... 12DC C1 / C2 / C3 / D1	... 24DC C1 / C2 / C3 / D1	... 48DC C1 / C2 / C3 / D1
IEC test classification/EN type	... 12AC C1 / C2 / C3 / D1			
Maximum continuous operating voltage $U_c$	6 V DC / 4 V AC	13 V DC / 9 V AC	28 V DC / 20 V AC	53 V DC / 37 V AC
Rated current	450 mA (45°C)	450 mA (45°C)	450 mA (45°C)	450 mA (45°C)
Pulse discharge current $I_{imp}$ (10/350) $\mu$ s	2.5 kA	2.5 kA	2.5 kA	2.5 kA
Nominal discharge current $I_n$ (8/20) $\mu$ s	Core-Core / Core-Ground		10 kA / 10 kA	10 kA / 10 kA
Total discharge current $I_{total}$ (8/20) $\mu$ s	20 kA	20 kA	20 kA	20 kA
Max. discharge current $I_{max}$ (8/20) $\mu$ s	10 kA	10 kA	10 kA	20 kA (in total)
Protection level $U_p$	Core-Core	$\leq 40$ V	$\leq 50$ V	$\leq 50$ V (C3 - 25 A)
	Core-Ground	$\leq 450$ V	$\leq 450$ V	$\leq 80$ V (C1 - 1 kV/500 A)
Output voltage limitation at 1 kV/ $\mu$ s	Core-Core	$\leq 10$ V	$\leq 18$ V	$\leq 40$ V
	Core-Ground	$\leq 450$ V	$\leq 450$ V	$\leq 450$ V (with PT 1X2-BE)
Cut-off frequency $f_g$ (3 dB)	Symmetrical in the 50 $\Omega$ system	typ. 1 MHz	typ. 3 MHz	typ. 4.5 MHz
		2.2 $\Omega$	2.2 $\Omega$	2.2 $\Omega$
Resistance per path	typ. 10 MHz			
General data	typ. 4 MHz			
Dimensions W/H/D	2.2 $\Omega$			
Connection data solid/stranded/AWG	17.7 mm / 90 mm / 65.5 mm			
Temperature range	0.2...4 mm <sup>2</sup> / 0.2...2.5 mm <sup>2</sup> / 24 ... 12			
Test standards	-40 °C ... 85 °C			
	IEC 61643-21			

#### Technical data

Electrical data	Technical data	
	... 12AC C1 / C2 / C3 / D1	... 24AC C1 / C2 / C3 / D1
Maximum continuous operating voltage $U_c$	18 V DC / 13 V AC	40 V DC / 28 V AC
Rated current	450 mA (45°C)	450 mA (45°C)
Pulse discharge current $I_{imp}$ (10/350) $\mu$ s	2.5 kA	2.5 kA
Nominal discharge current $I_n$ (8/20) $\mu$ s	Core-Core / Core-Ground	
Total discharge current $I_{total}$ (8/20) $\mu$ s	10 kA / 10 kA	10 kA / 10 kA
Max. discharge current $I_{max}$ (8/20) $\mu$ s	20 kA	20 kA
Protection level $U_p$	10 kA	10 kA
Output voltage limitation at 1 kV/ $\mu$ s	Core-Core	$\leq 25$ V
	Core-Ground	$\leq 450$ V
Cut-off frequency $f_g$ (3 dB)	typ. 4 MHz	typ. 8 MHz
	2.2 $\Omega$	2.2 $\Omega$
Resistance per path	17.7 mm / 90 mm / 65.5 mm	
General data	0.2...4 mm <sup>2</sup> / 0.2...2.5 mm <sup>2</sup> / 24 ... 12	
Dimensions W/H/D	-40 °C ... 85 °C	
Connection data solid/stranded/AWG	IEC 61643-21	
Temperature range		
Test standards		

#### Ordering data

Description	Voltage $U_N$	Type	Order No.	Pcs./Pkt.
<b>PLUGTRAB plug</b> , with protective circuit for plugging into the PT base element	5 V DC	PT 1X2-5DC-ST	2856016	10
	12 V DC	PT 1X2-12DC-ST	2856029	10
	24 V DC	PT 1X2-24DC-ST	2856032	10
	48 V DC	PT 1X2-48DC-ST	2803658	10
	12 V AC			
<b>PLUGTRAB base element</b> , for mounting on NS 35	24 V AC			
	Bridge between 3/4 ( $\frac{1}{2}$ ) and 9/10	PT 1X2-BE	2856113	10
Gas-filled surge arrester between 3/4 ( $\frac{1}{2}$ ) and 9/10		PT 1X2+F-BE	2856126	10

#### Ordering data

Description	Voltage $U_N$	Type	Order No.	Pcs./Pkt.
<b>PLUGTRAB plug</b> , with protective circuit for plugging into the PT base element	12 V AC	PT 1X2-12AC-ST	2856045	10
	24 V AC	PT 1X2-24AC-ST	2856058	10
<b>PLUGTRAB base element</b> , for mounting on NS 35	Bridge between 3/4 ( $\frac{1}{2}$ ) and 9/10	PT 1X2-BE	2856113	10
	Gas-filled surge arrester between 3/4 ( $\frac{1}{2}$ ) and 9/10	PT 1X2+F-BE	2856126	10



**SIL**  
evaluated  
IEC 61508



**2 double wires (loops), floating,  
e.g., for 4 ... 20 mA current loops**



**SIL**  
evaluated  
IEC 61508



**2 double wires (loops), floating,  
e.g., for 4 ... 20 mA current loops**



**Combination of double wire protection  
(floating) and single-phase power supply**

ERC  
Ex:

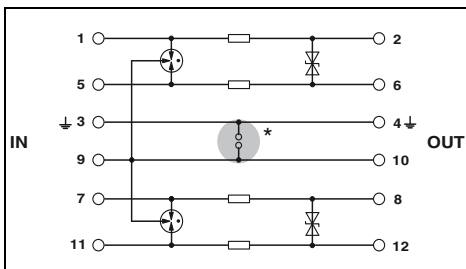

ERC  
Ex:

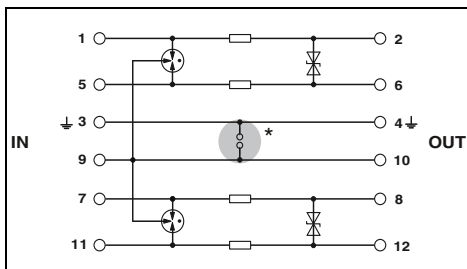

ERC

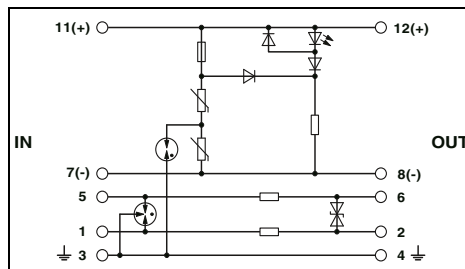

Technical data		
... 5DC	... 12DC	... 24DC
C1 / C2 / C3 / D1	C1 / C2 / C3 / D1	C1 / C2 / C3 / D1
6 V DC / 4 V AC	13 V DC / 9 V AC	28 V DC / 20 V AC
450 mA (45°C)	450 mA (45°C)	450 mA (45°C)
2.5 kA	2.5 kA	2.5 kA
10 kA / 10 kA	10 kA / 10 kA	10 kA / 10 kA
20 kA	20 kA	20 kA
10 kA	10 kA	20 kA (in total)
-	-	≤ 50 V (C3 - 25 A)
-	-	≤ 450 V (C1 - 1 kV / 500 A with PT 2X2-BE)
≤ 10 V	≤ 18 V	≤ 40 V
≤ 450 V	≤ 450 V	≤ 450 V (with PT 2X2-BE)
typ. 1 MHz	typ. 3 MHz	typ. 4.5 MHz
2.2 Ω	2.2 Ω	2.2 Ω
17.7 mm / 90 mm / 65.5 mm		
0.2...4 mm <sup>2</sup> / 0.2...2.5 mm <sup>2</sup> / 24 ... 12		
-40 °C ... 85 °C		
IEC 61643-21		

Technical data	
... 24AC	C1 / C2 / C3 / D1
40 V DC / 28 V AC	450 mA (45°C)
2.5 kA	
10 kA / 10 kA	
20 kA	
20 kA (in total)	
≤ 80 V (C2 - 10 kV / 5 kA)	
≤ 450 V (C2 - 10 kV / 5 kA with PT 2X2-BE)	
≤ 55 V	
≤ 450 V (with PT 2X2-BE)	
typ. 8 MHz	
2.2 Ω	
17.7 mm / 90 mm / 65.5 mm	
0.2...4 mm <sup>2</sup> / 0.2...2.5 mm <sup>2</sup> / 24 ... 12	
-40 °C ... 85 °C	
IEC 61643-21 / EN 61643-21	

Technical data	
Mains protection III / T3	Data protection C1 / C2 / C3 / D1
44 V DC / 34 V AC	40 V DC / 28 V AC
6 A (30 °C)	450 mA (45°C)
-	2.5 kA
700 A	10 kA / 10 kA
-	20 kA
2 kA	20 kA (in total)
≤ 0.18 kV	≤ 80 V (C2 - 10 kV / 5 kA)
≤ 0.55 kV	≤ 450 V (C2 - 10 kV / 5 kA)
-	≤ 55 V
-	≤ 25 V
-	typ. 8 MHz
-	2.2 Ω
17.7 mm / 90 mm / 65.5 mm	
0.2...4 mm <sup>2</sup> / 0.2...2.5 mm <sup>2</sup> / 24 ... 12	
-40 °C ... 85 °C	
IEC 61643-11 / EN 61643-11 / EN 61643-21	

Ordering data		
Type	Order No.	Pcs./Pkt.
PT 2X2- 5DC-ST	2838241	10
PT 2X2-12DC-ST	2838254	10
PT 2X2-24DC-ST	2838228	10
PT 2X2-BE	2839208	10
PT 2X2+F-BE	2839224	10

Ordering data		
Type	Order No.	Pcs./Pkt.
PT 2X2-24AC-ST	2838283	10
PT 2X2-BE	2839208	10
PT 2X2+F-BE	2839224	10

Ordering data		
Type	Order No.	Pcs./Pkt.
PT PE/S+1X2-24-ST	2819008	10
PT PE/S+1X2-BE	2856265	10

# Surge protection and interference suppression filters

## Surge protection for MCR technology

### Current loops and analog signals LINETRAB LIT

- Protection of up to four signal wires with an overall width of 6.2 mm
- Can be used in binary, analog, and intrinsically safe circuits

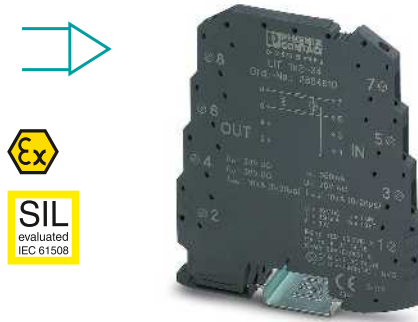

Double wire (loop), floating, e.g., for 4 ... 20 mA current loops

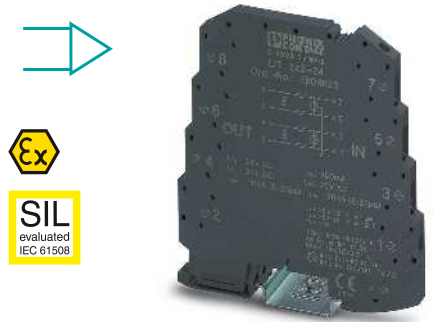

2 double wires (loops), floating, e.g., for 4 ... 20 mA current loops

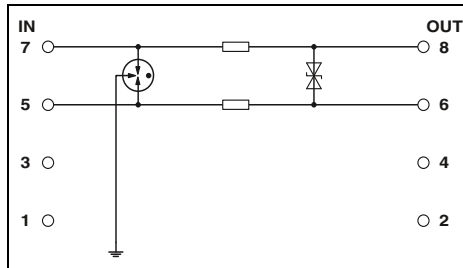

#### Technical data

<b>Electrical data</b>	
IEC test classification/EN type	C1 / C2 / C3 / D1
Maximum continuous operating voltage $U_C$	36 V DC / 25 V AC
Rated current	350 mA (40°C)
Pulse discharge current $I_{imp}$ (10/350) $\mu$ s	500 A
Nominal discharge current $I_n$ (8/20) $\mu$ s	
Total discharge current $I_{total}$ (8/20) $\mu$ s	Core-Core / Core-Ground
Protection level $U_p$	5 kA / 5 kA
	10 kA
Cut-off frequency $f_g$ (3 dB)	Core-Core / Core-Ground
	$\leq 50$ V (C3 - 10 A) / $\leq 650$ V (C1 - 500 V / 250 A)
Resistance per path	Symmetrical in the 50 $\Omega$ system
	typ. 6 MHz
	3.3 $\Omega$
<b>General data</b>	
Dimensions W/H/D	6.2 mm / 93.1 mm / 102.5 mm
Connection data solid/stranded/AWG	0.14...2.5 mm <sup>2</sup> / 0.2...2.5 mm <sup>2</sup> / 24 ... 12
Temperature range	-40 °C ... 80 °C
Test standards	EN 61643-21 / EN 60079-0 / EN 60079-11 / EN 60079-26 / IEC 60079-0 / IEC 60079-11
<b>Safety data</b>	
EC-type examination certificate according to ATEX	KEMA 09ATEX0051 X
Identification according to ATEX	Ex II 1 G Ex ia IIC T4...T6 Ex II 1 D Ex iaD 20 T85°C...135°C
Maximum internal capacitance $C_i$	typ. 1.3 nF
Maximum internal inductance $L_i$	< 1 $\mu$ H
Maximum input current $I_i$	350 mA (T4 / $\leq 80^\circ$ C)
Maximum input voltage $U_i$	36 V DC
Maximum input power $P_i$	3 W

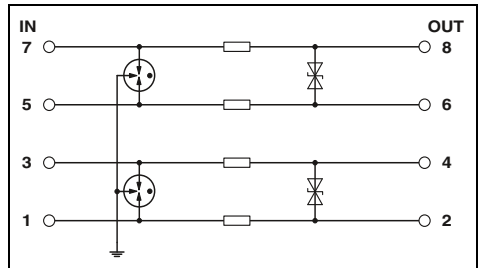

#### Technical data

<b>Electrical data</b>	
IEC test classification/EN type	C1 / C2 / C3 / D1
Maximum continuous operating voltage $U_C$	36 V DC / 25 V AC
Rated current	350 mA (40°C)
Pulse discharge current $I_{imp}$ (10/350) $\mu$ s	500 A
Nominal discharge current $I_n$ (8/20) $\mu$ s	
Total discharge current $I_{total}$ (8/20) $\mu$ s	Core-Core / Core-Ground
Protection level $U_p$	5 kA / 5 kA
	20 kA
Cut-off frequency $f_g$ (3 dB)	Core-Core / Core-Ground
	$\leq 50$ V (C3 - 10 A) / $\leq 650$ V (C1 - 500 V / 250 A)
Resistance per path	Symmetrical in the 50 $\Omega$ system
	typ. 6 MHz
	3.3 $\Omega$
<b>General data</b>	
Dimensions W/H/D	6.2 mm / 93 mm / 102.5 mm
Connection data solid/stranded/AWG	0.14...2.5 mm <sup>2</sup> / 0.2...2.5 mm <sup>2</sup> / 26 ... 12
Temperature range	-40 °C ... 80 °C
Test standards	EN 61643-21/A2 / EN 60079-0 / EN 60079-11 / EN 60079-26 / IEC 60079-0 / IEC 60079-11
<b>Safety data</b>	
EC-type examination certificate according to ATEX	KEMA 09ATEX0051 X
Identification according to ATEX	Ex II 1 G Ex ia IIC T4...T6 Ex II 1 D Ex iaD 20 T85°C...135°C
Maximum internal capacitance $C_i$	1.3 nF
Maximum internal inductance $L_i$	< 1 $\mu$ H
Maximum input current $I_i$	350 mA (T4 / $\leq 80^\circ$ C)
Maximum input voltage $U_i$	36 V DC
Maximum input power $P_i$	3 W

#### Ordering data

Description	Voltage $U_N$	Type	Order No.	Pcs./Pkt.
LINETRAB	24 V DC	LIT 1X2-24	2804610	10

#### Ordering data

Description	Voltage $U_N$	Type	Order No.	Pcs./Pkt.
LINETRAB	24 V DC	LIT 2X2-24	2804623	10

#### Accessories

System adapter, for MINI Analog modules with screw connection	Order No.	Pcs./Pkt.	
MINI MCR-SL-V8-FLK 16-A	2811268	1	
VARIOFACE system cable for connecting LIT and MINI Analog via system adapter			
Cable length: 2 m	VIP-CAB-FLK16/FR/FR/0,14/2,0M	2900156	1
Cable length: 1 m	VIP-CAB-FLK16/FR/FR/0,14/1,0M	2900155	1
Cable length: 0.5 m	VIP-CAB-FLK16/FR/FR/0,14/0,5M	2900154	1

#### Accessories

System adapter, for MINI Analog modules with screw connection	Order No.	Pcs./Pkt.	
MINI MCR-SL-V8-FLK 16-A	2811268	1	
VARIOFACE system cable for connecting LIT and MINI Analog via system adapter			
Cable length: 2 m	VIP-CAB-FLK16/FR/FR/0,14/2,0M	2900156	1
Cable length: 1 m	VIP-CAB-FLK16/FR/FR/0,14/1,0M	2900155	1
Cable length: 0.5 m	VIP-CAB-FLK16/FR/FR/0,14/0,5M	2900154	1

**Current loops and analog signals**  
**SURGETRAB S-PT**

- Easy assembly, directly on the field device
- Arresters in hexagonal tube with various outer threads
- **S-PT-1x2...** installation in the signal path feed-through



**Double wire (loop), floating, e.g., for 4 ... 20 mA current loops**

<b>Notes:</b>
For more information about EX approvals, visit <a href="http://phoenixcontact.com">phoenixcontact.com</a>
For additional safety data, visit <a href="http://phoenixcontact.net/products">phoenixcontact.net/products</a>

ERC

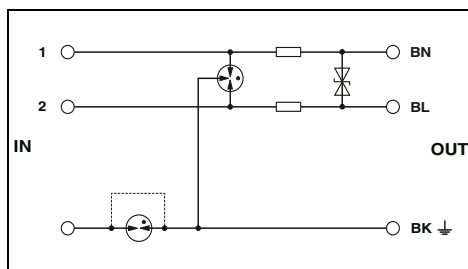

**Technical data**

<b>Electrical data</b>		
Maximum continuous operating voltage $U_c$		40 V DC / 28 V AC
Rated current		450 mA (55°C)
Pulse discharge current $I_{imp}$ (10/350) $\mu$ s		1 kA
Nominal discharge current $I_n$ (8/20) $\mu$ s		10 kA / 10 kA
Maximum permitted short-circuit current at installation location		1 A
Total discharge current $I_{total}$ (8/20) $\mu$ s		20 kA
Max. discharge current $I_{max}$ (8/20) $\mu$ s		10 kA
Protection level $U_p$	Core-Core	$\leq 80$ V (C2 - 5 kA)
	Core-Ground	$\leq 450$ V (C2 - 5 kA / direct grounding)
Output voltage limitation at 1 kV/ $\mu$ s	Core-Core / Core-Ground	$\leq 55$ V / $\leq 450$ V (Direct grounding)
Resistance per path		2.2 $\Omega$
<b>General data</b>		
Dimensions W/H/D		34 mm / 34 mm / 137 mm
Temperature range		-40 °C ... 85 °C
Test standards		IEC 61643-21

**Ordering data**

Description	Voltage $U_N$	Type	Order No.	Pcs./Pkt.
<b>SURGETRAB</b> , protective adapter for installation on measuring sensors				
Outer thread: M20 x 1.5	24 V DC	<b>S-PT-1X2-24DC</b>	<b>2880668</b>	1
Outer thread: 1/2" 14 NPT	24 V DC	<b>S-PT-1X2-24DC-1/2"</b>	<b>2882569</b>	1
Outer thread: 3/4" 14 NPT	24 V DC	<b>S-PT-1X2-24DC-3/4"</b>	<b>2882598</b>	1

# Surge protection and interference suppression filters

## Surge protection for MCR technology

### Current loops and analog signals COMTRAB CTM

- Space-saving LSA-PLUS connection technology
- Can be used in LSA-PLUS disconnect and control strips or CT-TERMIBLOCK
- The CTM 10-MAG surge protection magazine can be fitted with ten different protective plugs



Double wire (loop), floating

ERC

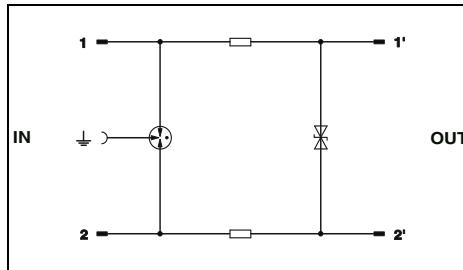

#### Technical data

	... 12DC			... 24DC			... 60DC		
	B2 / C1 / C2 / C3 / D1			B2 / C1 / C2 / C3 / D1			B2 / C1 / C2 / C3 / D1		
Electrical data									
IEC test classification/EN type									
Maximum continuous operating voltage $U_c$	± 15 V DC / 10 V AC			± 30 V DC / 21 V AC			60 V DC / 50 V AC		
Rated current	380 mA AC (25 °C)			380 mA AC (25 °C)			380 mA AC (25 °C)		
Pulse discharge current $I_{imp}$ (10/350) $\mu$ s	1 kA			1 kA			1 kA		
Nominal discharge current $I_n$ (8/20) $\mu$ s									
Total discharge current $I_{total}$ (8/20) $\mu$ s	Core-Core / Core-Ground			5 kA / 5 kA			5 kA / 5 kA		
Protection level $U_p$				10 kA			10 kA		
	Core-Core			≤ 25 V (C3, 7.5 kV/100 A)			≤ 45 V (C3, 7.5 kV/100 A)		
	Core-Ground			≤ 700 V (C3, 7.5 kV/100 A)			≤ 700 V (C3, 7.5 kV/100 A)		
Cut-off frequency $f_g$ (3 dB)									
	Symmetrical/asymmetrical in the 100 $\Omega$ system			1.2 MHz / -			2.7 MHz / -		
Resistance per path				3.3 $\Omega$			3.3 $\Omega$		
General data									
Dimensions W/H/D	9.5 mm / 21 mm / 53.5 mm								
Temperature range	-25 °C ... 75 °C								
Test standards	IEC 61643-21								

#### Ordering data

Description	Voltage $U_N$	Type	Order No.	Pcs./Pkt.
COMTRAB modular	12 V DC	CTM 1X2- 12DC	2838597	10
	24 V DC	CTM 1X2- 24DC	2838513	10
	60 V DC	CTM 1X2- 60DC	2838568	10

#### Accessories

Magazine, with grounding rail for accommodating up to 10 LSA-PLUS protective plugs (CTM...), for insertion in CT-TERMIBLOCK or LSA-PLUS disconnect strip	CTM 10-MAG	2838610	5
Grounding connector	CTM EST	2838649	10
Screw terminal block, with disconnect contacts for accommodating the CT and CTM protective plugs, design: 10 double wires	CT-TERMIBLOCK 10 DA	0441711	10

**Remote signaling set  
TERMITRAB complete**

- Overall width of just 2 x 6.2 mm
- With Push-in or screw connection technology
- Floating remote indication contact
- Visual status indicator on the module
- Monitors up to 40 neighboring SPDs
- No SPD wiring necessary
- No programming necessary

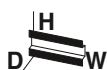

new



Transceiver module for remote signaling of  
TTC-6...-I products

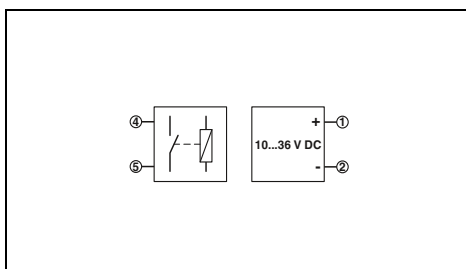

**Technical data**

Electrical data	
IEC test classification/EN type	
Maximum continuous operating voltage $U_C$	-
Rated current	-
General data	
Dimensions W/H/D	6.2 mm / 105.8 mm / 83.5 mm
Temperature range	-40 °C ... 60 °C
Test standards	EN 61000-6-2 / EN 61000-6-3
Remote indication contact	N/C contact
Connection data solid/stranded/AWG	0.2...4 mm <sup>2</sup> / 0.2...2.5 mm <sup>2</sup> / 24 ... 12
Max. operating voltage	24 V AC / 36 V DC
Max. operating current	500 mA AC (peak) / 500 mA DC

**Ordering data**

Description	Voltage $U_N$	Type	Order No.	Pcs./Pkt.
<b>Remote signaling set</b>				
Screw connection technology		TTC-6-FMRS-UT	2907810	1
Push-in connection technology		TTC-6-FMRS-PT	2907811	1

# Surge protection and interference suppression filters

## Surge protection for MCR technology

### Digital signals and switching contacts TERMITRAB complete

- Pluggable surge protection
- Overall width of just 6.2 mm
- With Push-in or screw connection technology
- Integrated mechanical status indicator
- Impedance-neutral insertion and removal
- Coded connector versions
- With knife disconnection as an option
- Optional remote signaling module monitors up to 40 items, without additional wiring
- Plugs can be tested with CHECKMASTER 2



new

2-conductor with common reference potential, 3/6 connection grounded directly, e.g., for binary signals



new

2-conductor with common reference potential, 3/6 connection grounded directly, with knife disconnection, e.g., for binary signals

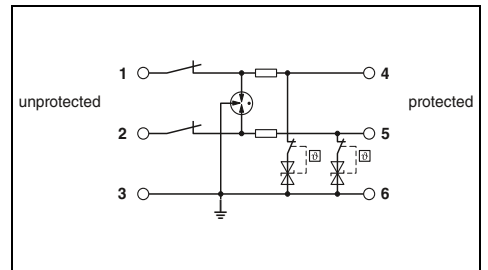
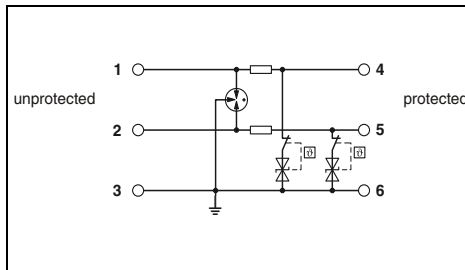

Electrical data	
IEC test classification/EN type	
Maximum continuous operating voltage $U_c$	15 V DC
Rated current	600 mA (40°C)
Pulse discharge current $I_{imp}$ (10/350) $\mu$ s	0.5 kA
Nominal discharge current $I_n$ (8/20) $\mu$ s	0.5 kA
Total discharge current $I_{total}$ (8/20) $\mu$ s	10 kA
Protection level $U_p$	≤ 25 V (C3 - 25 A)
Cut-off frequency $f_g$ (3 dB)	typ. 440 kHz
Resistance per path	1.65 $\Omega$
General data	
Dimensions W/H/D	
Connection data solid/stranded/AWG	
Temperature range	
Test standards	

Technical data		
... 12DC	... 24DC	... 48DC
C1 / C2 / C3 / D1	C1 / C2 / C3 / D1	C1 / C2 / C3 / D1
15 V DC	30 V DC	53 V DC
600 mA (40°C)	600 mA (40°C)	220 mA (75°C)
0.5 kA	0.5 kA	0.5 kA
Core-Core / Core-Ground	- / 5 kA	- / 5 kA
	10 kA	10 kA
Core-Core	-	-
Core-Ground	≤ 45 V (C3 - 25 A)	≤ 80 V (C3 - 25 A)
Asymmetrical in the 150 $\Omega$ system	typ. 960 kHz	typ. 1.7 MHz
	1.65 $\Omega$	1.65 $\Omega$
	6.2 mm / 105.8 mm / 100 mm	
	0.2...4 mm <sup>2</sup> / 0.2...2.5 mm <sup>2</sup> / 24 ... 12	
	-40 °C ... 85 °C	
	IEC 61643-21 / EN 61643-21	

Technical data		
... 24DC	... 48DC	
C1 / C2 / C3 / D1	C1 / C2 / C3 / D1	
30 V DC	53 V DC	
600 mA (40°C)	220 mA (75°C)	
0.5 kA	0.5 kA	
Core-Core / Core-Ground	- / 5 kA	
	10 kA	
Core-Core	-	
Core-Ground	≤ 45 V (C3 - 25 A)	
Asymmetrical in the 150 $\Omega$ system	typ. 960 kHz	
	1.65 $\Omega$	
	6.2 mm / 105.8 mm / 100 mm	
	0.2...4 mm <sup>2</sup> / 0.2...2.5 mm <sup>2</sup> / 24 ... 12	
	-40 °C ... 85 °C	
	IEC 61643-21 / EN 61643-21	

Description	Voltage $U_N$
<b>TERMITRAB complete, with screw connection technology</b>	
	12 V DC
	24 V DC
	48 V DC
<b>TERMITRAB complete, with Push-in connection technology</b>	
	12 V DC
	24 V DC
	48 V DC

Ordering data			
Type	Order No.	Pcs./Pkt.	
TTC-6P-2X1-12DC-UT-I	2908201	1	
TTC-6P-2X1-24DC-UT-I	2906810	1	
TTC-6P-2X1-48DC-UT-I	2908203	1	
TTC-6P-2X1-12DC-PT-I	2908202	1	
TTC-6P-2X1-24DC-PT-I	2906816	1	
TTC-6P-2X1-48DC-PT-I	2908204	1	

Ordering data			
Type	Order No.	Pcs./Pkt.	
TTC-6P-2X1-M-24DC-UT-I	2906741	1	
TTC-6P-2X1-M-24DC-PT-I	2906753	1	

Remote signaling set	
Screw connection technology	
Push-in connection technology	

Accessories			
Type	Order No.	Pcs./Pkt.	
TTC-6-FMRS-UT	2907810	1	
TTC-6-FMRS-PT	2907811	1	

Accessories			
Type	Order No.	Pcs./Pkt.	
TTC-6-FMRS-UT	2907810	1	
TTC-6-FMRS-PT	2907811	1	

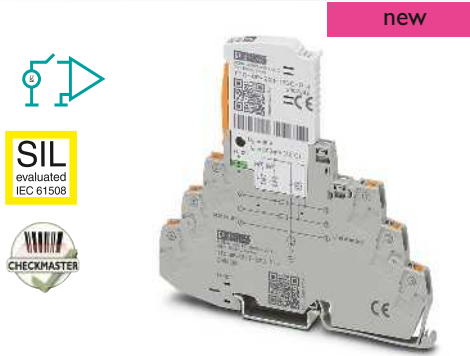

2-conductor with common reference potential, 3/6 connection grounded via gas-filled surge arrester, e.g., for binary signals

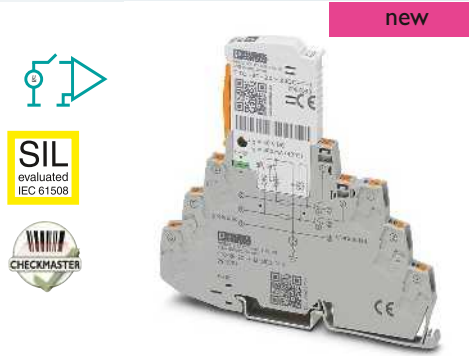

2-conductor with common reference potential, 3/6 connection grounded via gas-filled surge arrester, with knife disconnection, e.g., for binary signals

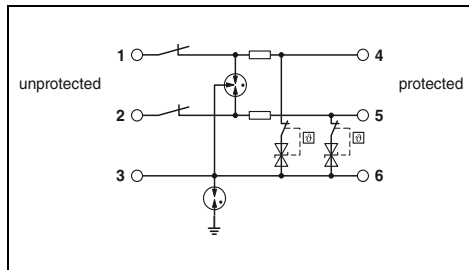
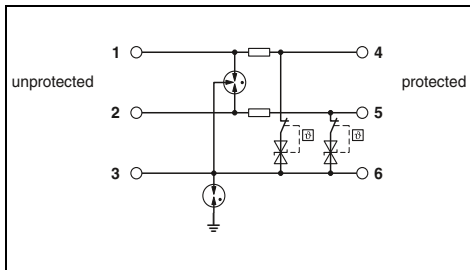

Technical data	
... 12DC	... 48DC
C1 / C2 / C3 / D1	C1 / C2 / C3 / D1
15 V DC	53 V DC
600 mA (40°C)	220 mA (75°C)
0.5 kA	0.5 kA
- / 5 kA	- / 5 kA
10 kA	10 kA
-	-
≤ 1.2 kV (C3 - 25 A)	≤ 800 V (C3 - 25 A)
-	-
1.65 Ω	1.65 Ω
6.2 mm / 105.8 mm / 100 mm	
0.2...4 mm <sup>2</sup> / 0.2...2.5 mm <sup>2</sup> / 24 ... 12	
-40 °C ... 85 °C	
IEC 61643-21 / EN 61643-21	

Technical data	
... 24DC	
C1 / C2 / C3 / D1	
30 V DC	
600 mA (40°C)	
0.5 kA	
- / 5 kA	
10 kA	
-	
≤ 1.1 kV (C3 - 25 A)	
-	
1.65 Ω	
6.2 mm / 105.8 mm / 100 mm	
0.2...4 mm <sup>2</sup> / 0.2...2.5 mm <sup>2</sup> / 24 ... 12	
-40 °C ... 85 °C	
IEC 61643-21 / EN 61643-21	

Ordering data		
Type	Order No.	Pcs./Pkt.
TTC-6P-2X1-F-12DC-UT-I	2908205	1
TTC-6P-2X1-F-48DC-UT-I	2908208	1
TTC-6P-2X1-F-12DC-PT-I	2908206	1
TTC-6P-2X1-F-48DC-PT-I	2908209	1

Ordering data		
Type	Order No.	Pcs./Pkt.
TTC-6P-2X1-F-M-24DC-UT-I	2906784	1
TTC-6P-2X1-F-M-24DC-PT-I	2906794	1

Accessories		
Type	Order No.	Pcs./Pkt.
TTC-6-FMRS-UT	2907810	1
TTC-6-FMRS-PT	2907811	1

Accessories		
Type	Order No.	Pcs./Pkt.
TTC-6-FMRS-UT	2907810	1
TTC-6-FMRS-PT	2907811	1

# Surge protection and interference suppression filters

## Surge protection for MCR technology

### Digital signals and switching contacts TERMITRAB complete

- One-piece or pluggable surge protection
- Overall width of just 6.2 mm
- With Push-in or screw connection technology
- Integrated mechanical status indicator
- Impedance-neutral insertion and removal
- Coded connector versions
- With knife disconnection as an option
- Optional remote signaling module monitors up to 40 items, without additional wiring
- Plugs can be tested with CHECKMASTER 2



SIL  
evaluated  
IEC 61508



new

2-conductor, floating, pluggable,  
e.g., for actuator circuits



SIL  
evaluated  
IEC 61508



new

2-conductor, floating, pluggable, with knife  
disconnection, e.g., for actuator circuits

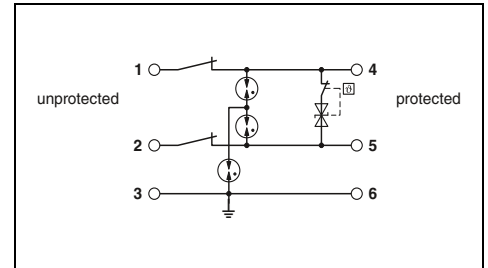
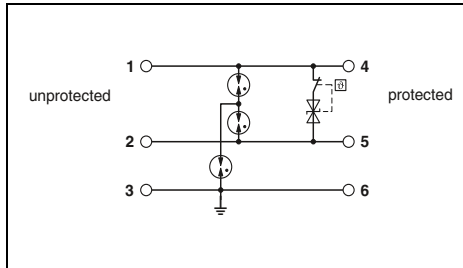

#### Technical data

Electrical data	... 24DC
IEC test classification/EN type	C1 / C2 / C3 / D1
Maximum continuous operating voltage $U_C$	30 V DC
Rated current	6 A (40°C)
Pulse discharge current $I_{imp}$ (10/350) $\mu$ s	0.5 kA
Nominal discharge current $I_n$ (8/20) $\mu$ s	
	Core-Core / Core-Ground
Total discharge current $I_{total}$ (8/20) $\mu$ s	0.5 kA / 5 kA
Protection level $U_p$	5 kA
	Core-Core
	Core-Ground
	$\leq 45$ V (C3 - 25 A)
	$\leq 850$ V (C3 - 25 A)
Cut-off frequency $f_g$ (3 dB)	
	Symmetrical in the 150 $\Omega$ system
Resistance per path	typ. 1 MHz
General data	100 m $\Omega$
Dimensions W/H/D	6.2 mm / 105.8 mm / 100 mm
Connection data solid/stranded/AWG	0.2...4 mm <sup>2</sup> / 0.2...2.5 mm <sup>2</sup> / 24 ... 12
Temperature range	-40 °C ... 85 °C
Test standards	IEC 61643-21 / EN 61643-21

Electrical data	... 24DC
IEC test classification/EN type	C1 / C2 / C3 / D1
Maximum continuous operating voltage $U_C$	30 V DC
Rated current	6 A (40°C)
Pulse discharge current $I_{imp}$ (10/350) $\mu$ s	0.5 kA
Nominal discharge current $I_n$ (8/20) $\mu$ s	
	Core-Core / Core-Ground
Total discharge current $I_{total}$ (8/20) $\mu$ s	0.5 kA / 5 kA
Protection level $U_p$	5 kA
	Core-Core
	Core-Ground
	$\leq 45$ V (C3 - 25 A)
	$\leq 850$ V (C3 - 25 A)
Cut-off frequency $f_g$ (3 dB)	
	Symmetrical in the 150 $\Omega$ system
Resistance per path	typ. 1 MHz
General data	100 m $\Omega$
Dimensions W/H/D	6.2 mm / 105.8 mm / 100 mm
Connection data solid/stranded/AWG	0.2...4 mm <sup>2</sup> / 0.2...2.5 mm <sup>2</sup> / 24 ... 12
Temperature range	-40 °C ... 85 °C
Test standards	IEC 61643-21 / EN 61643-21

#### Ordering data

Description	Voltage $U_N$
TERMITRAB complete, with screw connection technology	
	24 V DC
TERMITRAB complete, with Push-in connection technology	
	24 V DC

Type	Order No.	Pcs./Pkt.
TTC-6P-2-HC-24DC-UT-I	2906811	1
TTC-6P-2-HC-24DC-PT-I	2906817	1

#### Ordering data

Type	Order No.	Pcs./Pkt.
TTC-6P-2-HC-M-24DC-UT-I	2906743	1
TTC-6P-2-HC-M-24DC-PT-I	2906755	1

#### Accessories

Remote signaling set	
Screw connection technology	
Push-in connection technology	

Type	Order No.	Pcs./Pkt.
TTC-6-FMRS-UT	2907810	1
TTC-6-FMRS-PT	2907811	1

#### Accessories

Type	Order No.	Pcs./Pkt.
TTC-6-FMRS-UT	2907810	1
TTC-6-FMRS-PT	2907811	1



**SIL**  
evaluated  
IEC 61508



new

**2-conductor, floating, one-piece,  
e.g., for actuator circuits**



**SIL**  
evaluated  
IEC 61508



new

**2-conductor, floating, one-piece, with knife  
disconnection, e.g., for actuator circuits**

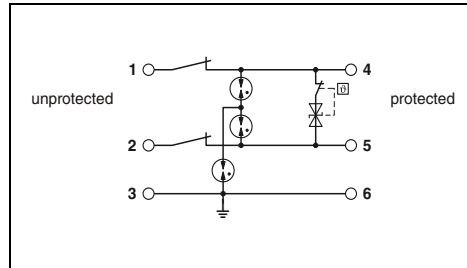
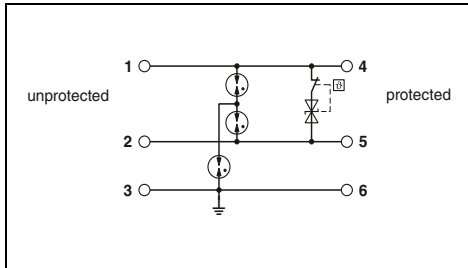

### Technical data

... 24DC  
C1 / C2 / C3 / D1  
30 V DC  
6 A (40°C)  
0.5 kA

0.5 kA / 5 kA  
5 kA

≤ 45 V (C3 - 25 A)  
≤ 850 V (C3 - 25 A)

typ. 1 MHz  
100 mΩ

6.2 mm / 105.8 mm / 83.5 mm  
0.2...4 mm<sup>2</sup> / 0.2...2.5 mm<sup>2</sup> / 24 ... 12  
-40 °C ... 85 °C  
IEC 61643-21 / EN 61643-21

### Technical data

... 24DC  
C1 / C2 / C3 / D1  
30 V DC  
6 A (40°C)  
0.5 kA

0.5 kA / 5 kA  
5 kA

≤ 45 V (C3 - 25 A)  
≤ 850 V (C3 - 25 A)

typ. 1 MHz  
100 mΩ

6.2 mm / 105.8 mm / 83.5 mm  
0.2...4 mm<sup>2</sup> / 0.2...2.5 mm<sup>2</sup> / 24 ... 12  
-40 °C ... 85 °C  
IEC 61643-21 / EN 61643-21

### Ordering data

Type	Order No.	Pcs./Pkt.
TTC-6-2-HC-24DC-UT-I	2908438	1
TTC-6-2-HC-24DC-PT-I	2908439	1

### Accessories

TTC-6-FMRS-UT	2907810	1
TTC-6-FMRS-PT	2907811	1

### Ordering data

Type	Order No.	Pcs./Pkt.
TTC-6-2-HC-M-24DC-UT-I	2906719	1
TTC-6-2-HC-M-24DC-PT-I	2906731	1

### Accessories

TTC-6-FMRS-UT	2907810	1
TTC-6-FMRS-PT	2907811	1

# Surge protection and interference suppression filters

## Surge protection for MCR technology

### Digital signals and switching contacts TERMITRAB complete

- Overall width of just 6.2 mm
- With Push-in or screw connection technology
- With integrated mechanical status indicator and knife disconnection as an option
- Optional remote signaling module monitors up to 40 items, without additional wiring



new

2-conductor with common reference potential, 3/6 connection grounded via gas-filled surge arrester, with or without status indicator and knife disconnection, e.g., for binary signals



new

2-conductor with common reference potential, 3/6 connection grounded via gas-filled surge arrester, with knife disconnection, e.g., for binary signals

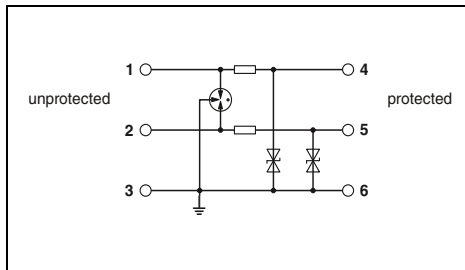

#### Technical data

Electrical data	... 24DC
IEC test classification/EN type	C1 / C2 / C3 / D1
Maximum continuous operating voltage $U_C$	30 V DC
Rated current	600 mA (40°C)
Pulse discharge current $I_{imp}$ (10/350) $\mu$ s	0.5 kA
Nominal discharge current $I_n$ (8/20) $\mu$ s	- / 5 kA
Total discharge current $I_{total}$ (8/20) $\mu$ s	10 kA
Protection level $U_p$	-
	Core-Core
	Core-Ground
	$\leq 45$ V (C3 - 25 A)
Cut-off frequency $f_g$ (3 dB)	Asymmetrical in the 150 $\Omega$ system
Resistance per path	typ. 960 kHz
General data	1.65 $\Omega$
Dimensions W/H/D	6.2 mm / 105.8 mm / 69.5 mm
Connection data solid/stranded/AWG	0.2...4 mm <sup>2</sup> / 0.2...2.5 mm <sup>2</sup> / 24 ... 12
Temperature range	-40 °C ... 85 °C
Test standards	IEC 61643-21 / EN 61643-21

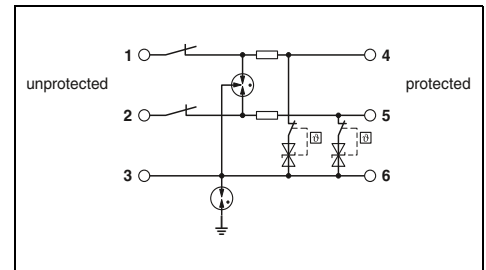

#### Technical data

Electrical data	... 24DC
IEC test classification/EN type	C1 / C2 / C3 / D1
Maximum continuous operating voltage $U_C$	30 V DC
Rated current	600 mA (40°C)
Pulse discharge current $I_{imp}$ (10/350) $\mu$ s	0.5 kA
Nominal discharge current $I_n$ (8/20) $\mu$ s	- / 5 kA
Total discharge current $I_{total}$ (8/20) $\mu$ s	10 kA
Protection level $U_p$	-
	Core-Core
	Core-Ground
	$\leq 1.1$ kV (C3 - 25 A)
Cut-off frequency $f_g$ (3 dB)	-
Resistance per path	1.65 $\Omega$
General data	
Dimensions W/H/D	6.2 mm / 105.8 mm / 83.5 mm
Connection data solid/stranded/AWG	0.2...4 mm <sup>2</sup> / 0.2...2.5 mm <sup>2</sup> / 24 ... 12
Temperature range	-40 °C ... 85 °C
Test standards	IEC 61643-21 / EN 61643-21

#### Ordering data

Description	Voltage $U_N$
<b>TERMITRAB complete</b> , with screw connection technology	
Without status indicator	24 V DC
With status indicator	24 V DC
<b>TERMITRAB complete</b> , with Push-in connection technology	
Without status indicator	24 V DC
With status indicator	24 V DC

Type	Order No.	Pcs./Pkt.
TTC-6-2X1-24DC-UT	2906799	1
TTC-6-2X1-M-24DC-UT-I	2906716	1
TTC-6-2X1-24DC-PT	2906805	1
TTC-6-2X1-M-24DC-PT-I	2906729	1

#### Ordering data

Type	Order No.	Pcs./Pkt.
TTC-6-2X1-F-M-24DC-UT-I	2906767	1
TTC-6-2X1-F-M-24DC-PT-I	2906776	1

#### Accessories

Remote signaling set
Screw connection technology
Push-in connection technology

Type	Order No.	Pcs./Pkt.
TTC-6-FMRS-UT	2907810	1
TTC-6-FMRS-PT	2907811	1

#### Accessories

Type	Order No.	Pcs./Pkt.
TTC-6-FMRS-UT	2907810	1
TTC-6-FMRS-PT	2907811	1

**Digital signals and switching contacts**  
**TERMITRAB complete**

new

- Overall width of just 3.5 mm
- With Push-in connection technology

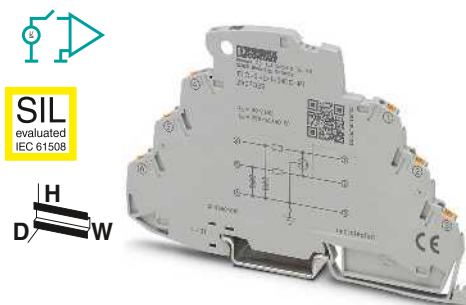

**2-conductor with common reference potential, e.g., for binary signals**

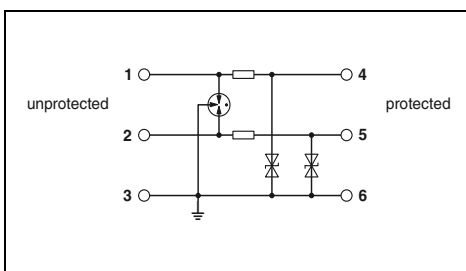

**Technical data**

Electrical data	... 24DC
IEC test classification/EN type	C1 / C2 / C3 / D1
Maximum continuous operating voltage $U_C$	30 V DC
Rated current	250 mA (70°C)
Pulse discharge current $I_{imp}$ (10/350) $\mu$ s	0.5 kA
Nominal discharge current $I_n$ (8/20) $\mu$ s	
	Core-Core / Core-Ground
Total discharge current $I_{total}$ (8/20) $\mu$ s	- / 5 kA
Protection level $U_p$	10 kA
	Core-Core
	Core-Ground
	-
Cut-off frequency fg (3 dB)	$\leq 50$ V (C3 - 30 A)
	Asymmetrical in the 150 $\Omega$ system
	-
Resistance per path	2.2 $\Omega$
General data	
Dimensions W/H/D	3.5 mm / 106 mm / 69.5 mm
Connection data solid/stranded/AWG	0.2...1.5 mm <sup>2</sup> / 0.2...1.5 mm <sup>2</sup> / 24 ... 16
Temperature range	-40 °C ... 85 °C
Test standards	IEC 61643-21 / EN 61643-21

**Ordering data**

Description	Voltage $U_N$	Type	Order No.	Pcs./Pkt.
<b>TERMITRAB complete</b> , with Push-in connection technology				
	24 V DC	TTC-3-2X1-24DC-PT	2907326	1

**Accessories**

<b>End cover</b>	TTC-3-LCP	2908843	1
------------------	-----------	---------	---

# Surge protection and interference suppression filters

## Surge protection for MCR technology

### Digital signals and switching contacts PLUGTRAB PT-IQ

- Multi-stage status monitoring
- Group message via supply and remote signaling module
- Multi-stage, floating remote signaling
- System supplied via DIN rail bus
- Up to 28 protection modules per supply module
- Maximum ease of maintenance thanks to the two-piece design
- Plugs are coded
- Impedance-neutral disconnection of plug for maintenance purposes
- PT-IQ... base element with Push-in or screw connection technology
- Base element remains an integral part of the installation
- Corresponding replacement plugs can be found on our website



Supply and remote signaling module



SIL  
evaluated  
IEC 61508



2-wire with common reference potential,  
connection 9/10 grounded directly,  
e.g., for binary signals

®. EAC

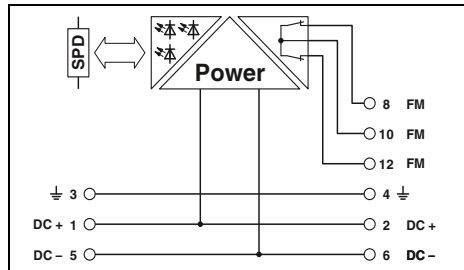

#### Technical data

<b>Electrical data</b>	
IEC test classification/EN type	
Maximum continuous operating voltage $U_C$	
Rated current	
Pulse discharge current $I_{imp}$ (10/350) $\mu$ s	
Nominal discharge current $I_n$ (8/20) $\mu$ s	
Core-Core / Core-Ground	
Total discharge current $I_{total}$ (8/20) $\mu$ s	- / -
Protection level $U_p$	-
Core-Ground	
Resistance per path	-
<b>General data</b>	
PT-IQ...UT dimensions W/H/D	17.7 mm / 91.1 mm / 77.5 mm
PT-IQ...PT dimensions W/H/D	17.7 mm / 109.3 mm / 77.5 mm
Connection data solid/stranded/AWG	0.2...4 mm <sup>2</sup> / 0.2...2.5 mm <sup>2</sup> / 24 ... 12
Temperature range	-40 °C ... 70 °C
Test standards	EN 61000-6-2 / EN 61000-6-3 / EN 60950-1 / EN 60079-0 / EN 60079-11 / EN 60079-15
<b>Remote indication contact</b>	
Connection data solid/stranded/AWG	
Max. operating voltage	
Max. operating current	

®. EAC

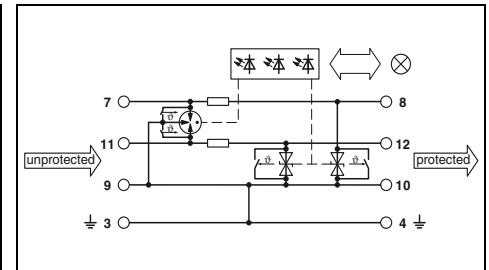

#### Technical data

... 24DC	... 48DC
C1 / C2 / C3 / D1	C1 / C2 / C3 / D1
30 V DC / 21 V AC	53 V DC / 37 V AC
1000 mA (40 °C)	300 mA
2.5 kA	2.5 kA
- / 10 kA	- / 10 kA
20 kA	20 kA
≤ 55 V (C3 - 25 A)	≤ 90 V (C3 - 25 A)
1.2 $\Omega$	1.2 $\Omega$
17.7 mm / 91.1 mm / 77.5 mm	
17.7 mm / 109.3 mm / 77.5 mm	
0.2...4 mm <sup>2</sup> / 0.2...2.5 mm <sup>2</sup> / 24 ... 12	
-40 °C ... 70 °C	
IEC 61643-21 / EN 61643-21 / EN 61000-6-3 / EN 61000-6-2	
Via TBUS	
- mm <sup>2</sup> / - mm <sup>2</sup> / -	

#### Ordering data

Description	Voltage $U_N$
<b>PLUGTRAB</b> , supply and remote signaling module	
Screw connection technology	
Push-in connection technology	
<b>PLUGTRAB</b> , with screw connection technology	24 V DC
	48 V DC
<b>PLUGTRAB</b> , with Push-in connection technology	24 V DC
	48 V DC

Type	Order No.	Pcs./Pkt.
PT-IQ-PTB-UT	2800768	1
PT-IQ-PTB-PT	2801296	1

#### Ordering data

Type	Order No.	Pcs./Pkt.
PT-IQ-2X1-24DC-UT	2800787	1
PT-IQ-2X1-48DC-UT	2800789	1
PT-IQ-2X1-24DC-PT	2801247	1
PT-IQ-2X1-48DC-PT	2801249	1



**SIL**  
evaluated  
IEC 61508



2-wire with common reference potential, connection 9/10 grounded via gas-filled surge arrester, e.g., for binary signals



**SIL**  
evaluated  
IEC 61508



4-wire with common reference potential, connection 9/10 grounded directly, e.g., for binary signals



**SIL**  
evaluated  
IEC 61508



4-wire with common reference potential, connection 9/10 grounded via gas-filled surge arrester, e.g., for binary signals

© EPC

© EPC

© EPC

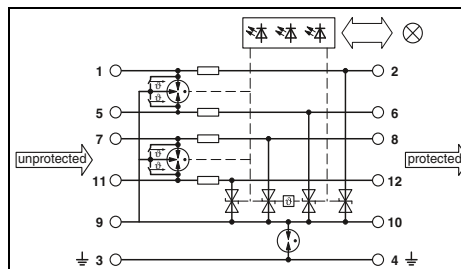
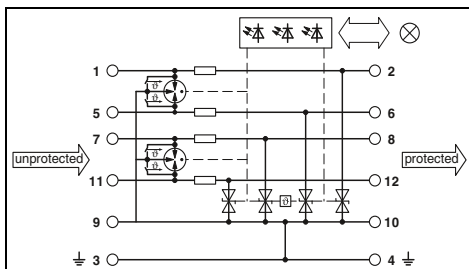
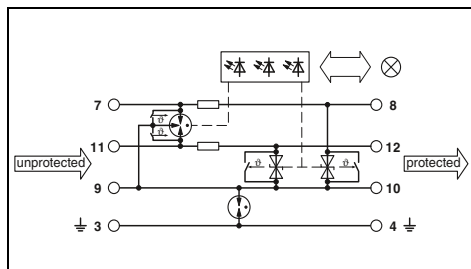

### Technical data

... 24DC	... 48DC
C1 / C2 / C3 / D1	C1 / C2 / C3 / D1
30 V DC / 21 V AC	53 V DC / 37 V AC
1000 mA (40°C)	300 mA
2.5 kA	300 mA
- / 10 kA	- / 10 kA
20 kA	20 kA
≤ 780 V (C3 - 25 A)	≤ 850 V (C3 - 25 A)
1.2 Ω	1.2 Ω

### Technical data

... 24DC	... 48DC
C1 / C2 / C3 / D1	C1 / C2 / C3 / D1
30 V DC / 21 V AC	53 V DC / 37 V AC
700 mA (50°C)	300 mA
2.5 kA	300 mA
- / 10 kA	- / 10 kA
20 kA	20 kA
≤ 180 V (C2 - 10 kA)	≤ 90 V (C3 - 25 A)
1.2 Ω	1.2 Ω

### Technical data

... 24DC	... 48DC
C1 / C2 / C3 / D1	C1 / C2 / C3 / D1
30 V DC / 21 V AC	53 V DC / 37 V AC
700 mA (50°C)	300 mA
2.5 kA	300 mA
- / 10 kA	- / 10 kA
20 kA	20 kA
≤ 780 V (C3 - 25 A)	≤ 850 V (C3 - 25 A)
1.2 Ω	1.2 Ω

17.7 mm / 91.1 mm / 77.5 mm  
17.7 mm / 109.3 mm / 77.5 mm  
0.2...4 mm<sup>2</sup> / 0.2...2.5 mm<sup>2</sup> / 24 ... 12  
-40 °C ... 70 °C

17.7 mm / 91.1 mm / 77.5 mm  
17.7 mm / 109.3 mm / 77.5 mm  
0.2...4 mm<sup>2</sup> / 0.2...2.5 mm<sup>2</sup> / 24 ... 12  
-40 °C ... 70 °C

17.7 mm / 91.1 mm / 77.5 mm  
17.7 mm / 109.3 mm / 77.5 mm  
0.2...4 mm<sup>2</sup> / 0.2...2.5 mm<sup>2</sup> / 24 ... 12  
-40 °C ... 70 °C

IEC 61643-21 / EN 61643-21 / EN 61000-6-3 / EN 61000-6-2

IEC 61643-21 / EN 61643-21 / EN 61000-6-3 / EN 61000-6-2

IEC 61643-21 / EN 61643-21 / EN 61000-6-3 / EN 61000-6-2

Via TBUS

Via TBUS

Via TBUS

- mm<sup>2</sup> / - mm<sup>2</sup> / -

- mm<sup>2</sup> / - mm<sup>2</sup> / -

- mm<sup>2</sup> / - mm<sup>2</sup> / -

### Ordering data

Type	Order No.	Pcs./Pkt.
PT-IQ-2X1+F-24DC-UT	2800788	1
PT-IQ-2X1+F-48DC-UT	2800790	1
PT-IQ-2X1+F-24DC-PT	2801248	1
PT-IQ-2X1+F-48DC-PT	2801250	1

### Ordering data

Type	Order No.	Pcs./Pkt.
PT-IQ-4X1-24DC-UT	2800982	1
PT-IQ-4X1-48DC-UT	2801219	1
PT-IQ-4X1-24DC-PT	2801271	1
PT-IQ-4X1-48DC-PT	2801273	1

### Ordering data

Type	Order No.	Pcs./Pkt.
PT-IQ-4X1+F-24DC-UT	2800983	1
PT-IQ-4X1+F-48DC-UT	2801220	1
PT-IQ-4X1+F-24DC-PT	2801272	1
PT-IQ-4X1+F-48DC-PT	2801274	1

# Surge protection and interference suppression filters

## Surge protection for MCR technology

### Digital signals and switching contacts PLUGTRAB PT

- Consistently pluggable signal circuit protection
- Maximum ease of maintenance thanks to the two-piece design
- Base element remains an integral part of the installation
- Impedance-neutral disconnection of plug for test and maintenance purposes
- Plugs can be checked with CHECKMASTER

**\* Note:**

Various grounding options for the base elements:

**PT .x.-BE** connections 9/10 (GND) directly connected to the mounting foot.

**PT .x.+F-BE** connections 9/10 (GND) connected to the mounting foot via a gas-filled surge arrester.

**Notes:**

For approvals and dimensional drawing, visit [phoenixcontact.net/products](http://phoenixcontact.net/products)



2-wire, with common reference potential, e.g., for binary signals

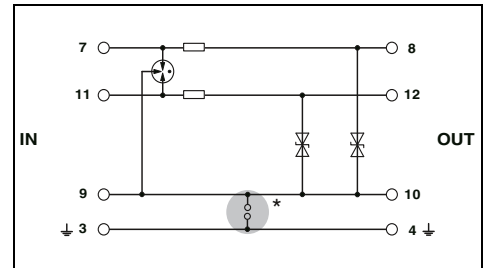

Electrical data	
IEC test classification/EN type	Core-Core / Core-Ground
Maximum continuous operating voltage $U_c$	Core-Ground
Rated current	
Pulse discharge current $I_{imp}$ (10/350) $\mu$ s	
Nominal discharge current $I_n$ (8/20) $\mu$ s	
Total discharge current $I_{total}$ (8/20) $\mu$ s	
Max. discharge current $I_{max}$ (8/20) $\mu$ s	
Output voltage limitation at 1 kV/ $\mu$ s	
Cut-off frequency $f_g$ (3 dB)	
Resistance per path	
General data	
Dimensions W/H/D	
Connection data solid/stranded/AWG	
Temperature range	
Test standards	

Technical data		
... 5DC	... 12DC	... 24DC
C1 / C2 / C3 / D1	C1 / C2 / C3 / D1	C1 / C2 / C3 / D1
6 V DC / 4 V AC	13 V DC / 9 V AC	28 V DC / 20 V AC
300 mA (45°C)	300 mA (45°C)	300 mA (45°C)
2.5 kA	2.5 kA	2.5 kA
- / 10 kA	- / 10 kA	- / 10 kA
20 kA	20 kA	20 kA
10 kA	10 kA	10 kA
≤ 10 V	≤ 18 V	≤ 40 V
- / typ. 1 MHz	- / typ. 3 MHz	- / typ. 4.5 MHz
4.7 $\Omega$	4.7 $\Omega$	4.7 $\Omega$
17.7 mm / 90 mm / 65.5 mm		
0.2...4 mm <sup>2</sup> / 0.2...2.5 mm <sup>2</sup> / 24 ... 12		
-40 °C ... 85 °C		
IEC 61643-21		

Description	Voltage $U_N$
<b>PLUGTRAB plug</b> , with protective circuit for plugging into the PT base element	
	5 V DC
	12 V DC
	24 V DC
	48 V DC
	12 V AC
	24 V AC
	48 V AC
<b>PLUGTRAB base element</b> , for mounting on NS 35	
with bridge between the connections 3/4 ( $\perp$ ) and 9/10	
with gas-filled surge arrester between the connections 3/4 ( $\perp$ ) and 9/10	
<b>Shield fast connection</b>	
For $\varnothing$ 3-6 mm	
For $\varnothing$ 5-10 mm	

Ordering data		
Type	Order No.	Pcs./Pkt.
<b>PT 2X1-5DC-ST</b>	<b>2856061</b>	10
<b>PT 2X1-12DC-ST</b>	<b>2856074</b>	10
<b>PT 2X1-24DC-ST</b>	<b>2856087</b>	10
<b>PT 2X1-BE</b>	<b>2856139</b>	10
<b>PT 2X1+F-BE</b>	<b>2856142</b>	10
Accessories		
<b>SSA 3-6</b>	<b>2839295</b>	10
<b>SSA 5-10</b>	<b>2839512</b>	10

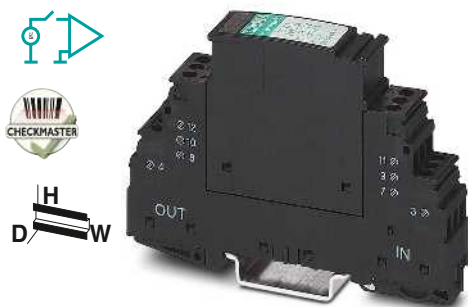

2-wire, with common reference potential, e.g., for binary signals



4-wire with common reference potential, connection 9/10 grounded directly, e.g., for binary signals



4-wire with common reference potential, connection 9/10 grounded via gas-filled surge arrester, e.g., for binary signals

ERC  
Ex:

ERC  
Ex:

ERC  
Ex:

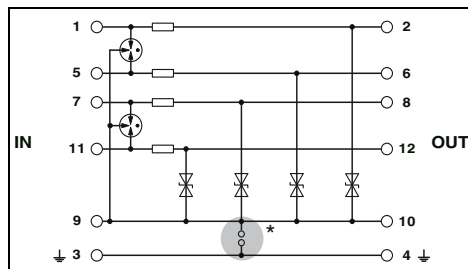
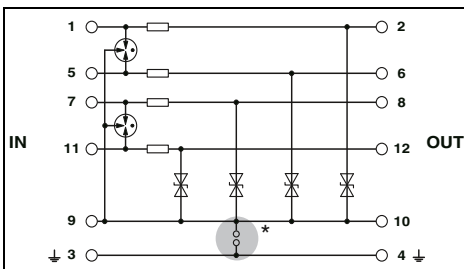
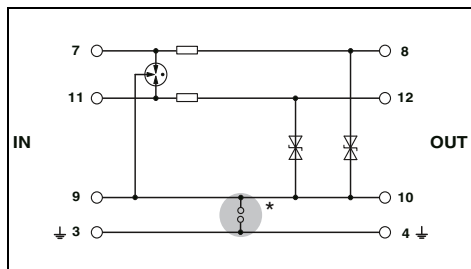

Technical data	
... 12AC	... 24AC
C1 / C2 / C3 / D1	C1 / C2 / C3 / D1
18 V DC / 13 V AC	40 V DC / 28 V AC
300 mA (45°C)	300 mA (45°C)
2.5 kA	2.5 kA
- / 10 kA	- / 10 kA
20 kA	20 kA
10 kA	10 kA
≤ 25 V	≤ 55 V (with PT 2x1-BE)
- / typ. 4 MHz	- / typ. 8 MHz
4.7 Ω	4.7 Ω
17.7 mm / 90 mm / 65.5 mm 0.2...4 mm <sup>2</sup> / 0.2...2.5 mm <sup>2</sup> / 24 ... 12 -40 °C ... 85 °C IEC 61643-21	

Technical data			
... 5DC	... 12DC	... 24DC	... 48DC
C1 / C2 / C3 / D1	C1 / C2 / C3 / D1	C1 / C2 / C3 / D1	C1 / C2 / C3 / D1
6 V DC / 4 V AC	13 V DC / 9 V AC	28 V DC / 20 V AC	53 V DC / 37 V AC
300 mA (45°C)	300 mA (45°C)	300 mA (45°C)	300 mA (45°C)
2.5 kA	2.5 kA	2.5 kA	2.5 kA
- / 10 kA	- / 10 kA	- / 10 kA	- / 10 kA
20 kA	20 kA	20 kA	20 kA
10 kA	10 kA	10 kA	10 kA
≤ 10 V	≤ 18 V	≤ 40 V	≤ 70 V
- / typ. 1 MHz	- / typ. 3 MHz	- / typ. 6 MHz	- / typ. 9 MHz
4.7 Ω	4.7 Ω	4.7 Ω	4.7 Ω
17.7 mm / 90 mm / 65.5 mm 0.2...4 mm <sup>2</sup> / 0.2...2.5 mm <sup>2</sup> / 24 ... 12 -40 °C ... 85 °C IEC 61643-21			

Technical data	
... 24AC	... 48AC
C1 / C2 / C3 / D1	C1 / C2 / C3 / D1
40 V DC / 28 V AC	77 V DC / 55 V AC
300 mA (45°C)	300 mA (45°C)
2.5 kA	2.5 kA
- / 10 kA	- / 10 kA
20 kA	20 kA
10 kA	10 kA (per path)
≤ 55 V	-
- / typ. 8 MHz	- / typ. 10 MHz
4.7 Ω	4.7 Ω
17.7 mm / 90 mm / 65.5 mm - mm <sup>2</sup> / - mm <sup>2</sup> / - -40 °C ... 85 °C IEC 61643-21	

Ordering data		
Type	Order No.	Pcs./Pkt.
PT 2X1-12AC-ST	2856090	10
PT 2X1-24AC-ST	2856100	10
PT 2X1-BE	2856139	10
PT 2X1+F-BE	2856142	10

Ordering data		
Type	Order No.	Pcs./Pkt.
PT 4X1- 5DC-ST	2838306	10
PT 4X1-12DC-ST	2838319	10
PT 4X1-24DC-ST	2838322	10
PT 4X1-48DC-ST	2858014	10
PT 4X1-BE	2839363	10
PT 4X1+F-BE	2839376	10

Ordering data		
Type	Order No.	Pcs./Pkt.
PT 4X1-24AC-ST	2838351	10
PT 4X1-48AC-ST	2804856	10
PT 4X1-BE	2839363	10
PT 4X1+F-BE	2839376	10

Accessories		
SSA 3-6	2839295	10
SSA 5-10	2839512	10

Accessories		
SSA 3-6	2839295	10
SSA 5-10	2839512	10

Accessories		
SSA 3-6	2839295	10
SSA 5-10	2839512	10

# Surge protection and interference suppression filters

## Surge protection for MCR technology

### Digital signals and switching contacts PLUGTRAB PT

- Protective devices for higher nominal power
  - Consistently pluggable signal circuit protection
  - Maximum ease of maintenance thanks to the two-piece design
  - Base element remains an integral part of the installation
  - Impedance-neutral disconnection of plug for test and maintenance purposes
  - Plugs can be checked with CHECKMASTER
  - FM types with permanent and independent monitoring by a diagnostics unit
- \* Note:** If no protective plug is inserted, there is no electrical connection.

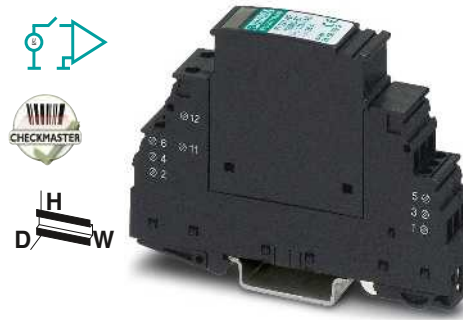

2-wire, floating, free of leakage current, e.g., for actuator circuits

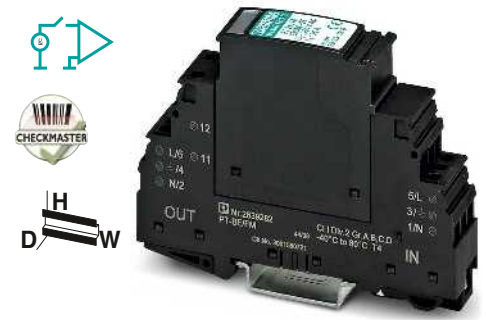

2-wire, with common reference potential, remote signaling, e.g., for actuator circuits

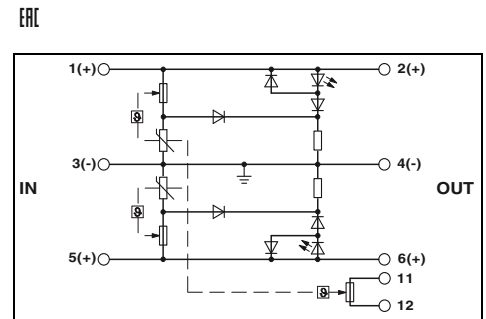
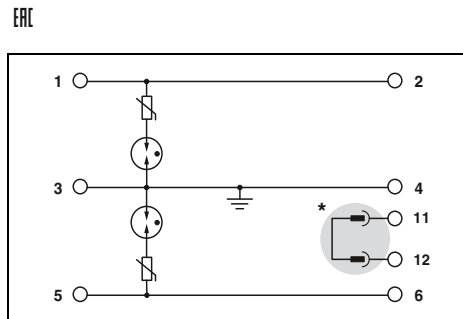

Electrical data	
IEC test classification/EN type	C1 / C2 / C3
Maximum continuous operating voltage $U_c$	- / 175 V AC
Rated current	6 A
Pulse discharge current $I_{imp}$ (10/350) $\mu$ s	300 A
Nominal discharge current $I_n$ (8/20) $\mu$ s	500 A
Total discharge current $I_{total}$ (8/20) $\mu$ s	3 kA
Output voltage limitation at 1 kV/ $\mu$ s	8 kA
	Core-Ground
	$\leq 800$ V
General data	
Dimensions W/H/D	17.7 mm / 90 mm / 65.5 mm
Connection data solid/stranded/AWG	0.2...4 mm <sup>2</sup> / 0.2...2.5 mm <sup>2</sup> / 24 ... 12
Temperature range	-40 °C ... 80 °C
Test standards	EN 61643-21

Technical data	
... 120AC	... 230AC
C1 / C2 / C3	C1 / C2 / C3 / D1
- / 175 V AC	- / 250 V AC
6 A	6 A
300 A	500 A
3 kA	3 kA
8 kA	8 kA
	Core-Ground
	$\leq 1.4$ kV
General data	
Dimensions W/H/D	17.7 mm / 90 mm / 65.5 mm
Connection data solid/stranded/AWG	0.2...4 mm <sup>2</sup> / 0.2...2.5 mm <sup>2</sup> / 24 ... 12
Temperature range	-40 °C ... 80 °C
Test standards	EN 61643-21

Technical data		
... 60AC	... 120AC	... 230AC
C1 / C2 / C3 / D1	C1 / C2 / C3 / D1	C1 / C2 / C3 / D1
100 V DC / 75 V AC (50/60 Hz)	150 V DC / 150 V AC (50/60 Hz)	275 V DC / 275 V AC (50/60 Hz)
26 A AC (30 °C)	26 A AC (30 °C)	26 A AC (30 °C)
500 A	500 A	500 A
2 kA	2.5 kA	2.5 kA
4 kA	5 kA	5 kA
	Core-Ground	
	$\leq 200$ V	$\leq 650$ V
General data		
Dimensions W/H/D	17.7 mm / 90 mm / 65.5 mm	
Connection data solid/stranded/AWG	0.2...4 mm <sup>2</sup> / 0.2...2.5 mm <sup>2</sup> / 24 ... 12	
Temperature range	-40 °C ... 85 °C	
Test standards	IEC 61643-21/A2 / EN 61643-21/A2	

Description	Voltage $U_N$
<b>MAINS-PLUGTRAB</b> , consisting of a plug and a base element	120 V AC 230 V AC
<b>PLUGTRAB plug</b> , with protective circuit for plugging into the PT base element	60 V AC 120 V AC 230 V AC
<b>PLUGTRAB base element</b> , for mounting on NS 35	

Ordering data			
Type	Order No.	Pcs./Pkt.	
PT 2X1-VF-120AC	2859327	10	
PT 2X1-VF-230AC	2805460	10	
PT 2X1-VF-120AC-ST	2856799	10	
PT 2X1-VF-230AC-ST	2921365	10	
PT-BE/FM	2839282	10	

Ordering data			
Type	Order No.	Pcs./Pkt.	
PT 2X1VA- 60AC-ST	2839172	10	
PT 2X1VA-120AC-ST	2839185	10	
PT 2X1VA-230AC-ST	2839198	10	
PT-BE/FM	2839282	10	

Shield fast connection	
For $\varnothing$ 3-6 mm	
For $\varnothing$ 5-10 mm	

Accessories		
SSA 3-6	2839295	10
SSA 5-10	2839512	10

Accessories		
SSA 3-6	2839295	10
SSA 5-10	2839512	10

### Digital signals and switching contacts PLUGTRAB PT

- For systems with high dielectric strength or fine protection installed
- Installation location - directly where the MCR cable enters the building
- Consistently pluggable signal circuit protection
- Maximum ease of maintenance thanks to the two-piece design
- Base element remains an integral part of the installation
- Impedance-neutral disconnection of plug for test and maintenance purposes
- Plugs can be checked with CHECKMASTER



2-wire, coarse protection,  
e.g., for actuator circuits



4-wire, coarse protection,  
e.g., for actuator circuits

ERC

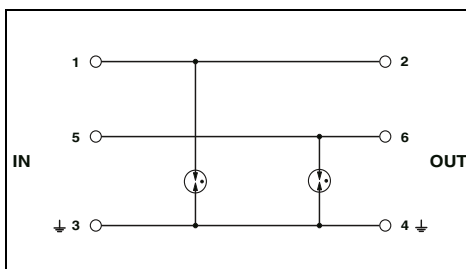

ERC

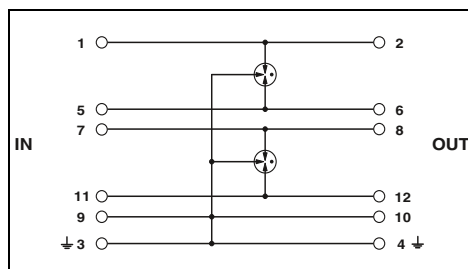

#### Technical data

Electrical data	
IEC test classification/EN type	
Maximum continuous operating voltage $U_C$	
Rated current	
Pulse discharge current $I_{imp}$ (10/350) $\mu s$	
Nominal discharge current $I_n$ (8/20) $\mu s$	
Total discharge current $I_{total}$ (8/20) $\mu s$	
Protection level $U_p$	
Output voltage limitation at 1 kV/ $\mu s$	
General data	
Dimensions W/H/D	
Connection data solid/stranded/AWG	
Temperature range	
Test standards	

C1 / C2 / C3 / D1
60 V DC / 48 V AC
2 A AC (80 °C)
5 kA
Core-Core / Core-Ground
- / 20 kA
20 kA
Core-Ground
$\leq 600$ V (C2 - 10 kV / 5 kA)
Core-Ground
$\leq 600$ V
17.7 mm / 90 mm / 65.5 mm
0.2...4 mm <sup>2</sup> / 0.2...2.5 mm <sup>2</sup> / 24 ... 12
-40 °C ... 85 °C
IEC 61643-21 / EN 61643-21

#### Technical data

C1 / C2 / C3 / D1
60 V DC / 120 V AC
2 A AC (80 °C)
2.5 kA
10 kA / 10 kA
20 kA
$\leq 450$ V (C2 - 10 kV / 5 kA with PT 4-BE)
$\leq 450$ V (with PT 4-BE)
17.7 mm / 90 mm / 65.5 mm
0.2...4 mm <sup>2</sup> / 0.2...2.5 mm <sup>2</sup> / 24 ... 12
-40 °C ... 85 °C
IEC 61643-21 / EN 61643-21

#### Ordering data

Description	Voltage $U_N$
PLUGTRAB plug, with protective circuit for plugging into the PT base element	48 V AC 110 V AC
PLUGTRAB base element, for mounting on NS 35	
Bridge between 3/4 ( $\pm$ ) and 9/10	

Type	Order No.	Pcs./Pkt.
PT 2-F-ST	2859000	10
PT-BE/FM	2839282	10

#### Ordering data

Type	Order No.	Pcs./Pkt.
PT 4-F-ST	2858441	10
PT 4-BE	2839402	10

#### Accessories

Shield fast connection
For $\varnothing$ 3-6 mm
For $\varnothing$ 5-10 mm

SSA 3-6	2839295	10
SSA 5-10	2839512	10

#### Accessories

SSA 3-6	2839295	10
SSA 5-10	2839512	10

# Surge protection and interference suppression filters

## Surge protection for MCR technology

### Digital signals and switching contacts PLUGTRAB PT

- Consistently pluggable signal circuit protection
- Maximum ease of maintenance thanks to the two-piece design
- Base element remains an integral part of the installation
- Impedance-neutral disconnection of plug for test and maintenance purposes
- Plugs can be checked with CHECKMASTER



4-wire, floating, impedance-free,  
e.g., for temperature measurement

**\* Note:**

Various grounding options for the base elements:

**PT .x.-BE** connections 9/10 (GND) directly connected to the mounting foot.

**PT .x.+F-BE** connections 9/10 (GND) connected to the mounting foot via a gas-filled surge arrester.

ERC

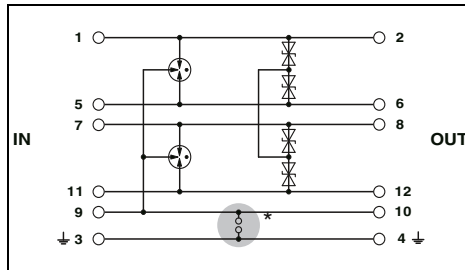

#### Technical data

Electrical data	... 5DC	... 12DC	... 24DC	... 24AC
	IEC test classification/EN type	C1 / C2 / C3 / D1	C1 / C2 / C3 / D1	C1 / C2 / C3 / D1
Maximum continuous operating voltage $U_c$	6 V DC / 4 V AC	12.8 V DC / 9 V AC	27 V DC / 19 V AC	40 V DC / 28 V AC
Rated current	2 A (80 °C)	2 A (80 °C)	2 A (80 °C)	2 A AC (80 °C)
Pulse discharge current $I_{imp}$ (10/350) $\mu$ s	2.5 kA	2.5 kA	2.5 kA	2.5 kA
Nominal discharge current $I_n$ (8/20) $\mu$ s	Core-Core / Core-Ground			
Total discharge current $I_{total}$ (8/20) $\mu$ s	720 A / 10 kA	690 A / 10 kA	365 A / 10 kA	187 A / 10 kA
Max. discharge current $I_{max}$ (8/20) $\mu$ s	20 kA	20 kA	20 kA	20 kA
Output voltage limitation at 1 kV/ $\mu$ s	10 kA	10 kA	10 kA	10 kA
	Core-Core	$\leq 10$ V	$\leq 18$ V	$\leq 40$ V
	Core-Ground	$\leq 450$ V	$\leq 450$ V	$\leq 450$ V (with PT 4-BE)
General data	17.7 mm / 90 mm / 65.5 mm			
Dimensions W/H/D	0.2...4 mm <sup>2</sup> / 0.2...2.5 mm <sup>2</sup> / 24 ... 12			
Connection data solid/stranded/AWG	-40 °C ... 85 °C			
Temperature range	IEC 61643-21			
Test standards				

#### Ordering data

Description	Voltage $U_N$	Type	Order No.	Pcs./Pkt.
<b>PLUGTRAB plug</b> , with protective circuit for plugging into the PT base element	5 V DC	PT 4- 5DC-ST	2839211	10
	12 V DC	PT 4-12DC-ST	2839237	10
	24 V DC	PT 4-24DC-ST	2839240	10
	24 V AC	PT 4-24AC-ST	2800078	1
<b>PLUGTRAB base element</b> , for mounting on NS 35		PT 4-BE	2839402	10
		PT 4+F-BE	2839415	10

#### Accessories

Shield fast connection			
For $\varnothing$ 3-6 mm	SSA 3-6	2839295	10
For $\varnothing$ 5-10 mm	SSA 5-10	2839512	10

### Digital signals and switching contacts LINETRAB LIT

- Protection of up to four signal wires with an overall width of 6.2 mm
- Can be used in binary, analog, and intrinsically safe circuits

**Notes:**  
For approvals and dimensional drawing, visit [phoenixcontact.net/products](http://phoenixcontact.net/products)



Protection for two conductors with a common reference potential



Protection for four conductors with a common reference potential

ERC

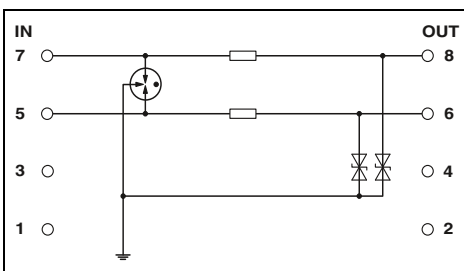

#### Technical data

Electrical data	
IEC test classification/EN type	C1 / C2 / C3 / D1
Maximum continuous operating voltage $U_C$	36 V DC / 25 V AC
Rated current	350 mA (40°C)
Pulse discharge current $I_{imp}$ (10/350) $\mu$ s	500 A
Nominal discharge current $I_n$ (8/20) $\mu$ s	
	Core-Core / Core-Ground
Total discharge current $I_{total}$ (8/20) $\mu$ s	- / 5 kA
Max. discharge current $I_{max}$ (8/20) $\mu$ s	10 kA
Protection level $U_p$	20 kA (Total)
	Core-Core / Core-Ground
Cut-off frequency $f_g$ (3 dB)	- / $\leq$ 60 V (C1 - 500 V / 250 A)
	Asymmetrical in the 50 $\Omega$ system
Resistance per path	typ. 6 MHz
General data	3.3 $\Omega$
Dimensions W/H/D	6.2 mm / 93 mm / 102.5 mm
Connection data solid/stranded/AWG	0.14...2.5 mm <sup>2</sup> / 0.2...2.5 mm <sup>2</sup> / 26 ... 12
Temperature range	-40 °C ... 80 °C
Test standards	IEC 61643-21 / DIN EN 61643-21

ERC

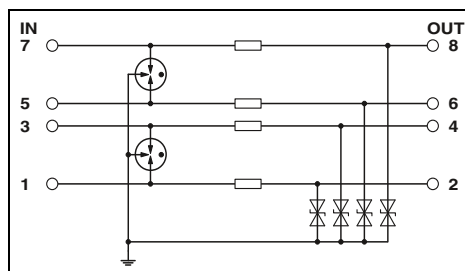

#### Technical data

Electrical data	
IEC test classification/EN type	C1 / C2 / C3 / D1
Maximum continuous operating voltage $U_C$	36 V DC / 25 V AC
Rated current	350 mA (40°C)
Pulse discharge current $I_{imp}$ (10/350) $\mu$ s	500 A
Nominal discharge current $I_n$ (8/20) $\mu$ s	
	Core-Core / Core-Ground
Total discharge current $I_{total}$ (8/20) $\mu$ s	- / 5 kA
Max. discharge current $I_{max}$ (8/20) $\mu$ s	20 kA
Protection level $U_p$	10 kA
	Core-Core / Core-Ground
Cut-off frequency $f_g$ (3 dB)	- / $\leq$ 60 V (C1 - 500 V / 250 A)
	Asymmetrical in the 50 $\Omega$ system
Resistance per path	typ. 6 MHz
General data	3.3 $\Omega$
Dimensions W/H/D	6.2 mm / 93 mm / 102.5 mm
Connection data solid/stranded/AWG	0.14...2.5 mm <sup>2</sup> / 0.2...2.5 mm <sup>2</sup> / 26 ... 12
Temperature range	-40 °C ... 80 °C
Test standards	IEC 61643-21 / DIN EN 61643-21

#### Ordering data

Description	Voltage $U_N$	Type	Order No.	Pcs./Pkt.
LINETRAB LIT surge protection	24 V DC	LIT 2X1-24	2804636	10

#### Ordering data

Description	Voltage $U_N$	Type	Order No.	Pcs./Pkt.
LINETRAB LIT surge protection	24 V DC	LIT 4X1-24	2804649	10

# Surge protection and interference suppression filters

## Surge protection for MCR technology

### Digital signals and switching contacts SURGETRAB S-PT

- Easy assembly, directly on the field device
- Arresters in hexagonal tube with various outer threads
- **S-PT-4-EX** installation in a separate cable gland parallel to the signal cables



**4-wire with common reference potential,  
intrinsically safe, encapsulated, without  
decoupling resistance**

ERC  
Ex:

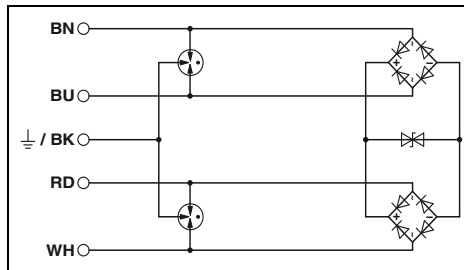

#### Technical data

Electrical data	
IEC test classification/EN type	C1 / C2 / C3 / D1
Maximum continuous operating voltage $U_C$	36 V DC / 25 V AC
Pulse discharge current $I_{imp}$ (10/350) $\mu$ s	1 kA
Nominal discharge current $I_n$ (8/20) $\mu$ s	
Maximum permitted short-circuit current at installation location	260 A / 10 kA
Total discharge current $I_{total}$ (8/20) $\mu$ s	1 A (non-Ex)
Protection level $U_p$	20 kA
	Core-Core $\leq 65$ V (C3 - 10 A)
	Core-Ground $\leq 1.1$ kV (C3 - 100 A)
Output voltage limitation at 1 kV/ $\mu$ s	Core-Core / Core-Ground $\leq 60$ V / -
General data	
Dimensions W/H/D	28 mm / 28 mm / 79 mm
Temperature range	-40 °C ... 80 °C (non-Ex)
Test standards	EN 61643-21/A2 / EN 60079-0 / EN 60079-1 / EN 60079-11 / EN 60079-26 / EN 60079-31
Safety data	
EC-type examination certificate according to ATEX	KEMA 09ATEX0028 X
Identification according to ATEX	II 1 G Ex ia IIC T4...T6 II 2 G Ex d IIC T4...T6
Maximum internal capacitance $C_i$	1.65 nF
Maximum internal inductance $L_i$	1 $\mu$ H
Maximum input current $I_i$	500 mA (T4 / $\leq 75$ °C)
Maximum input voltage $U_i$	36 V DC
Maximum input power $P_i$	3 W

#### Ordering data

Description	Voltage $U_N$	Type	Order No.	Pcs./Pkt.
<b>SURGETRAB</b> protective adapter for installation on measuring sensors for Ex protection zones				
Outer thread: M20 x 1.5	24 V DC	<b>S-PT-4-EX-24DC</b>	<b>2800036</b>	1
Outer thread: 1/2" 14 NPT	24 V DC	<b>S-PT-4-EX-24DC-1/2"</b>	<b>2800037</b>	1

**Digital signals and switching contacts  
COMTRAB CTM**

- Space-saving LSA-PLUS connection technology
- Can be used in LSA-PLUS disconnect and control strips or CT-TERMIBLOCK
- The CTM 10-MAG surge protection magazine can be fitted with ten different protective plugs



2-wire, with common reference potential

ERC

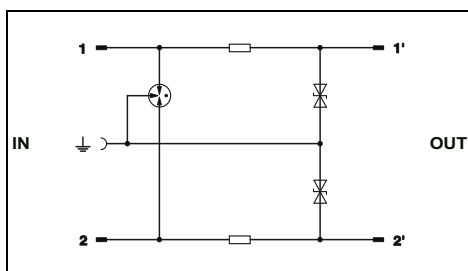

**Technical data**

Electrical data	... 12DC			... 24DC			... 60DC		
	B2 / C1 / C2 / C3 / D1			B2 / C1 / C2 / C3 / D1			B2 / C1 / C2 / C3 / D1		
IEC test classification/EN type									
Maximum continuous operating voltage $U_C$	± 15 V DC / 10 V AC			± 30 V DC / 21 V AC			60 V DC / 50 V AC		
Rated current	380 mA AC (25 °C)			380 mA AC (25 °C)			380 mA AC (25 °C)		
Pulse discharge current $I_{imp}$ (10/350) $\mu$ s	1 kA			1 kA			1 kA		
Nominal discharge current $I_n$ (8/20) $\mu$ s	Core-Core / Core-Ground			- / 5 kA			- / 5 kA		
Total discharge current $I_{total}$ (8/20) $\mu$ s	Core-Core / Core-Ground			- / 10 kA			- / 10 kA		
Output voltage limitation at 1 kV/ $\mu$ s	Core-Core			-			-		
	Core-Ground			≤ 22 V			≤ 45 V		
Cut-off frequency $f_g$ (3 dB)	Symmetrical/asymmetrical in the 100 $\Omega$ system			- / 1.5 MHz			- / 2.7 MHz		
Resistance per path				3.3 $\Omega$			3.3 $\Omega$		
General data									
Dimensions W/H/D				9.5 mm / 21 mm / 53.5 mm					
Temperature range				-25 °C ... 75 °C					
Test standards							IEC 61643-21		

**Ordering data**

Description	Voltage $U_N$	Type	Order No.	Pcs./Pkt.
<b>COMTRAB modular</b> , surge protection for a double wire with coarse and fine protection and ohmic decoupling, DSL-compatible	12 V DC	CTM 2X1- 12DC	2838584	10
	24 V DC	CTM 2X1- 24DC	2838500	10
	60 V DC	CTM 2X1- 60DC	2838542	10

**Accessories**

<b>Magazine</b> , with grounding rail for accommodating up to 10 LSA-PLUS protective plugs (CTM...), for insertion in CT-TERMIBLOCK or LSA-PLUS disconnect strip	CTM 10-MAG	2838610	5
<b>Grounding connector</b>	CTM EST	2838649	10
<b>Screw terminal block</b> , with disconnect contacts for accommodating the CT and CTM protective plugs, design: 10 double wires	CT-TERMIBLOCK 10 DA	0441711	10

# Surge protection and interference suppression filters

## Surge protection for MCR technology

### Resistance-dependent measurements TERMITRAB complete

- Overall width of just 6.2 mm
- With Push-in or screw connection technology

new



2-conductor, floating, impedance-free,  
e.g., for temperature measurement

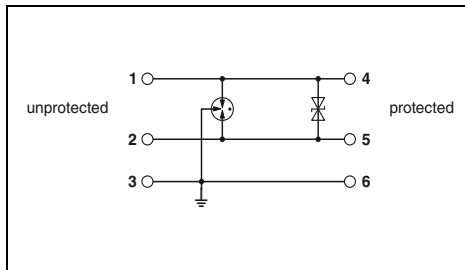

#### Technical data

Electrical data		
IEC test classification/EN type		C1 / C2 / C3 / D1
Maximum continuous operating voltage $U_C$		30 V DC
Rated current		450 mA (40°C)
Pulse discharge current $I_{imp}$ (10/350) $\mu$ s		0.5 kA
Nominal discharge current $I_n$ (8/20) $\mu$ s		
Total discharge current $I_{total}$ (8/20) $\mu$ s		Core-Core / Core-Ground
Protection level $U_p$		0.5 kA / 5 kA
		10 kA
Cut-off frequency $f_g$ (3 dB)		Core-Core $\leq 45$ V (C3 - 25 A)
		Core-Ground $\leq 600$ V (C3 - 25 A)
Resistance per path		Symmetrical in the 150 $\Omega$ system
General data		typ. 1.1 MHz
Dimensions W/H/D		100 m $\Omega$
Connection data solid/stranded/AWG		6.2 mm / 105.8 mm / 69.5 mm
Temperature range		0.2...4 mm <sup>2</sup> / 0.2...2.5 mm <sup>2</sup> / 24 ... 12
Test standards		-40 °C ... 85 °C
		IEC 61643-21 / EN 61643-21

#### Ordering data

Description	Voltage $U_N$	Type	Order No.	Pcs./Pkt.
TERMITRAB complete, with screw connection technology	24 V DC	TTC-6-2-24DC-UT	2906800	1
TERMITRAB complete, with Push-in connection technology	24 V DC	TTC-6-2-24DC-PT	2906806	1

### Resistance-dependent measurements PLUGTRAB PT

- Consistently pluggable signal circuit protection
- Maximum ease of maintenance thanks to the two-piece design
- Base element remains an integral part of the installation
- Impedance-neutral disconnection of plug for test and maintenance purposes
- Plugs can be checked with CHECKMASTER



4-wire, floating, impedance-free,  
e.g., for temperature measurement

**\* Note:**

Various grounding options for the base elements:

**PT .x.-BE** connections 9/10 (GND) directly connected to the mounting foot.

**PT .x.+F-BE** connections 9/10 (GND) connected to the mounting foot via a gas-filled surge arrester.

ERC

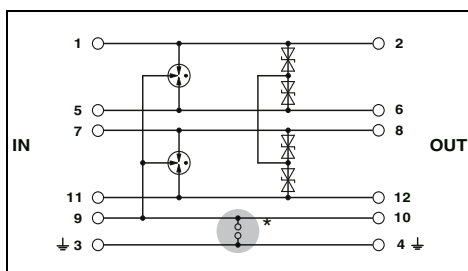

#### Technical data

Electrical data	... 5DC	... 12DC	... 24DC	... 24AC
	C1 / C2 / C3 / D1	C1 / C2 / C3 / D1	C1 / C2 / C3 / D1	C1 / C2 / C3 / D1
Maximum continuous operating voltage $U_C$	6 V DC / 4 V AC	12.8 V DC / 9 V AC	27 V DC / 19 V AC	40 V DC / 28 V AC
Pulse discharge current $I_{imp}$ (10/350) $\mu$ s	2.5 kA	2.5 kA	2.5 kA	2.5 kA
Rated current	2 A (80 °C)	2 A (80 °C)	2 A (80 °C)	2 A AC (80 °C)
Nominal discharge current $I_n$ (8/20) $\mu$ s	720 A / 10 kA	690 A / 10 kA	365 A / 10 kA	187 A / 10 kA
Total discharge current $I_{total}$ (8/20) $\mu$ s	20 kA	20 kA	20 kA	20 kA
Max. discharge current $I_{max}$ (8/20) $\mu$ s	10 kA	10 kA	10 kA	10 kA
Output voltage limitation at 1 kV/ $\mu$ s	Core-Core / Core-Ground	Core-Core / Core-Ground	Core-Core / Core-Ground	Core-Core / Core-Ground
	$\leq 10$ V	$\leq 18$ V	$\leq 40$ V	$\leq 75$ V
	$\leq 450$ V	$\leq 450$ V	$\leq 450$ V (with PT 4-BE)	-
General data	17.7 mm / 90 mm / 65.5 mm			
Dimensions W/H/D	0.2...4 mm <sup>2</sup> / 0.2...2.5 mm <sup>2</sup> / 24 ... 12			
Connection data	Solid/stranded/AWG			
Temperature range	-40 °C ... 85 °C			
Test standards	IEC 61643-21 / DIN EN 61643-21 / UL 497B			

#### Ordering data

Description	Voltage $U_N$	Type	Order No.	Pcs./Pkt.
<b>PLUGTRAB plug</b> , with protective circuit for plugging into the PT base element	5 V DC	PT 4-5DC-ST	2839211	10
	12 V DC	PT 4-12DC-ST	2839237	10
	24 V DC	PT 4-24DC-ST	2839240	10
	24 V AC	PT 4-24AC-ST	2800078	1
<b>PLUGTRAB base element</b> , for mounting on NS 35	Bridge between 3/4 ( $\downarrow$ ) and 9/10	PT 4-BE	2839402	10
	Gas-filled surge arrester between 3/4 ( $\downarrow$ ) and 9/10	PT 4+F-BE	2839415	10

#### Accessories

Shield fast connection	Order No.	Pcs./Pkt.
For $\varnothing$ 3-6 mm	2839295	10
For $\varnothing$ 5-10 mm	2839512	10

# Surge protection and interference suppression filters

## Surge protection for MCR technology

### Resistance-dependent measurements SURGETRAB

- Easy assembly, directly on the field device
- Arresters in hexagonal tube with various outer threads
- **S-PT-4-EX** installation in a separate cable gland parallel to the signal cables



**4-wire with common reference potential,  
intrinsically safe, encapsulated, without  
decoupling resistance**

ERC  
Ex:

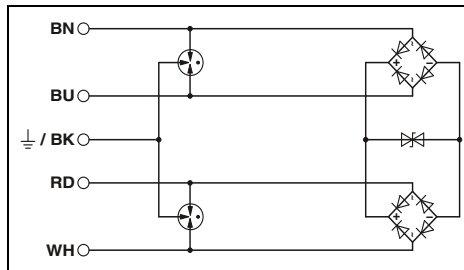

#### Technical data

Electrical data	... 24DC
IEC test classification/EN type	C1 / C2 / C3 / D1
Maximum continuous operating voltage $U_C$	36 V DC / 25 V AC
Pulse discharge current $I_{imp}$ (10/350) $\mu$ s	1 kA
Nominal discharge current $I_n$ (8/20) $\mu$ s	
	Core-Core / Core-Ground
Maximum permitted short-circuit current at installation location	260 A / 10 kA
Total discharge current $I_{total}$ (8/20) $\mu$ s	1 A (non-Ex)
Max. discharge current $I_{max}$ (8/20) $\mu$ s	20 kA
Protection level $U_p$	-
	Core-Core
	Core-Ground
Output voltage limitation at 1 kV/ $\mu$ s	$\leq 65$ V (C3 - 10 A)
	$\leq 1.1$ kV (C3 - 100 A)
	Core-Core / Core-Ground
Output voltage limitation at 1 kV/ $\mu$ s	$\leq 60$ V / -
General data	
Dimensions W/H/D	28 mm / 28 mm / 79 mm
Temperature range	-40 °C ... 80 °C (non-Ex)
Test standards	EN 61643-21/A2 / EN 60079-0 / EN 60079-1 / EN 60079-11 / EN 60079-26 / EN 60079-31
Safety data	
EC-type examination certificate according to ATEX	KEMA 09ATEX0028 X
Identification according to ATEX	II 1 G Ex ia IIC T4...T6
	II 2 G Ex d IIC T4...T6
Maximum internal capacitance $C_i$	1.65 nF
Maximum internal inductance $L_i$	1 $\mu$ H
Maximum input current $I_i$	500 mA (T4 / $\leq 75$ °C)
Maximum input voltage $U_i$	36 V DC
Maximum input power $P_i$	3 W

#### Ordering data

Description	Voltage $U_N$	Type	Order No.	Pcs./Pkt.
<b>SURGETRAB</b> protective adapter for installation on measuring sensors for Ex protection zones				
Outer thread: M20 x 1.5	24 V DC	<b>S-PT-4-EX-24DC</b>	<b>2800036</b>	1
Outer thread: 1/2" 14 NPT	24 V DC	<b>S-PT-4-EX-24DC-1/2"</b>	<b>2800037</b>	1

### Resistance-dependent measurements LINETRAB LIT

- Protection of up to four signal wires with an overall width of 6.2 mm
- Can be used in binary, analog, and intrinsically safe circuits



4-wire, floating, impedance-free,  
e.g., for temperature measurement

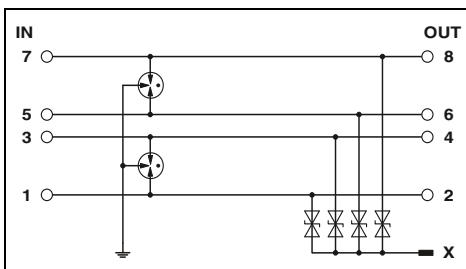

#### Technical data

Electrical data	... 12DC	... 24DC
IEC test classification/EN type	C1 / C2 / C3 / D1	C1 / C2 / C3 / D1
Maximum continuous operating voltage $U_C$	18 V DC / 13 V AC	36 V DC / 25 V AC
Rated current	500 mA (40°C)	500 mA (40°C)
Pulse discharge current $I_{imp}$ (10/350) $\mu$ s	500 A	500 A
Nominal discharge current $I_n$ (8/20) $\mu$ s		
	Core-Core / Core-Ground	Core-Core / Core-Ground
Total discharge current $I_{total}$ (8/20) $\mu$ s	350 A / 5 kA	250 A / 5 kA
Max. discharge current $I_{max}$ (8/20) $\mu$ s	20 kA	20 kA
Protection level $U_p$	10 kA	10 kA
	Core-Core / Core-Ground	Core-Core / Core-Ground
	$\leq 50$ V (C3 - 10 A) / $\leq 650$ V (C2 - 10 kV / 5 kA)	$\leq 60$ V (C3 - 10 A) / $\leq 650$ V (C2 - 10 kV / 5 kA)
Cut-off frequency $f_g$ (3 dB)		
	Symmetrical in the 50 $\Omega$ system	Symmetrical in the 50 $\Omega$ system
Resistance per path	typ. 5 MHz	typ. 7.7 MHz
General data	0 $\Omega$	0 $\Omega$
Dimensions W/H/D	6.2 mm / 93 mm / 102.5 mm	
Connection data solid/stranded/AWG	0.14...2.5 mm <sup>2</sup> / 0.2...2.5 mm <sup>2</sup> / 26 ... 12	
Temperature range	-40 °C ... 80 °C	
Test standards	EN 61643-21/A2 / EN 60079-0 / EN 60079-11 / EN 60079-26 / IEC 60079-0 / IEC 60079-11	
<b>Safety data</b>		
EC-type examination certificate according to ATEX	KEMA 09ATEX0051 X	KEMA 09ATEX0051 X
Identification according to ATEX	Ex II 1 G Ex ia IIC T4...T6 Ex II 1 D Ex iaD 20 T85°C...135°C	Ex II 1 G Ex ia IIC T4...T6 Ex II 1 D Ex iaD 20 T85°C...135°C
Maximum internal capacitance $C_i$	6 nF	2.5 nF
Maximum internal inductance $L_i$	< 1 $\mu$ H	< 1 $\mu$ H
Maximum input current $I_i$	500 mA (T4 / -40...+80°C)	500 mA (T4 / -40...+80°C)
Maximum input voltage $U_i$	18 V DC	36 V DC
Maximum input power $P_i$	550 mW	550 mW

#### Ordering data

Description	Voltage $U_N$	Type	Order No.	Pcs./Pkt.
LINETRAB	12 V DC	LIT 4-12	2804704	10
	24 V DC	LIT 4-24	2804678	10

#### Accessories

DIN rail connector	ME 6,2 TBUS-2 1,5/5-ST-3,81KMGY	2969401	10
--------------------	---------------------------------	---------	----

# Surge protection and interference suppression filters

## Surge protection for MCR technology

### Single-stage protective devices TERMITRAB complete

- Fine surge protection for signal circuits on electronic controllers
- Overall width of just 6.2 mm
- With Push-in or screw connection technology
- Integrated mechanical status indicator
- Optional remote signaling module monitors up to 40 items, without additional wiring



new

2-conductor with common reference potential, e.g., for binary signals



new

1-conductor with grounded reference potential

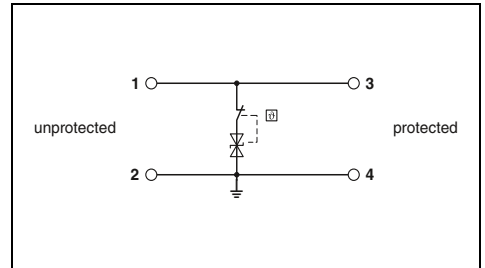
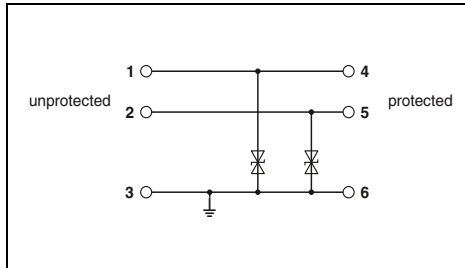

#### Technical data

Electrical data	... 24DC
IEC test classification/EN type	C1 / C3
Maximum continuous operating voltage $U_C$	30 V DC
Rated current	6 A (40°C)
Protection level $U_p$	
	Core-Ground $\leq 45$ V (C3 - 25 A)
	Core-GND -
Cut-off frequency $f_g$ (3 dB)	Asymmetrical in the 150 $\Omega$ system
Resistance per path	typ. 960 kHz 100 m $\Omega$
General data	
Dimensions W/H/D	6.2 mm / 105.8 mm / 69.5 mm
Connection data solid/stranded/AWG	0.2...4 mm <sup>2</sup> / 0.2...2.5 mm <sup>2</sup> / 24 ... 12
Temperature range	-40 °C ... 85 °C
Test standards	IEC 61643-21 / EN 61643-21

Technical data			
... 12DC	... 24DC	... 48DC	... 60DC
C1 / C3	C3	C3	C3
15 V DC	30 V DC	53 V DC	75 V DC
10 A (60°C)	10 A (60°C)	10 A (60°C)	10 A (60°C)
$\leq 22$ V (C3 - 25 A)	$\leq 50$ V (C3 - 25 A)	$\leq 80$ V (C3 - 18 A)	$\leq 110$ V (C3 - 12 A)
typ. 1.1 MHz	typ. 1.7 MHz	typ. 3.5 MHz	typ. 4 MHz
100 m $\Omega$	100 m $\Omega$	100 m $\Omega$	100 m $\Omega$
6.2 mm / 92 mm / 69.5 mm			
0.2...4 mm <sup>2</sup> / 0.2...2.5 mm <sup>2</sup> / 24 ... 12			
-40 °C ... 85 °C			
IEC 61643-21 / EN 61643-21			

#### Ordering data

Description	Voltage $U_N$
TERMITRAB complete, with Push-in connection technology	
	24 V DC
TERMITRAB complete, with screw connection technology	
	12 V DC
	24 V DC
	48 V DC
	60 V DC
TERMITRAB complete, with Push-in connection technology	
	12 V DC
	24 V DC
	48 V DC
	60 V DC

#### Ordering data

Type	Order No.	Pcs./Pkt.
TTC-6-2XTVSD-24DC-PT	2906808	1
TTC-6-TVSD-C-12DC-UT-I	2906829	1
TTC-6-TVSD-C-24DC-UT-I	2906831	1
TTC-6-TVSD-C-48DC-UT-I	2906832	1
TTC-6-TVSD-C-60DC-UT-I	2906833	1
TTC-6-TVSD-C-12DC-PT-I	2906847	1
TTC-6-TVSD-C-24DC-PT-I	2906848	1
TTC-6-TVSD-C-48DC-PT-I	2906849	1
TTC-6-TVSD-C-60DC-PT-I	2906850	1

#### Accessories

End cover
Remote signaling set
Screw connection technology
Push-in connection technology

#### Accessories

Type	Order No.	Pcs./Pkt.
TTC-6-LCP	2908729	1
TTC-6-FMRS-UT	2907810	1
TTC-6-FMRS-PT	2907811	1

new

SIL  
evaluated  
IEC 61508

H  
D/W



2-conductor, floating

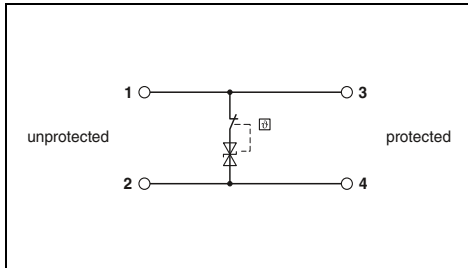

### Technical data

... 24DC	... 48DC	... 60DC
C3	C3	C3
30 V DC	53 V DC	75 V DC
10 A (60°C)	10 A (60°C)	10 A (60°C)
-	-	-
≤ 50 V (C3 - 25 A)	≤ 80 V (C3 - 18 A)	≤ 110 V (C3 - 12 A)
-	-	-
100 mΩ	100 mΩ	100 mΩ

6.2 mm / 92 mm / 69.5 mm  
0.2...4 mm<sup>2</sup> / 0.2...2.5 mm<sup>2</sup> / 24 ... 12  
-40 °C ... 85 °C  
IEC 61643-21 / EN 61643-21

### Ordering data

Type	Order No.	Pcs./Pkt.
TTC-6-TVSD-D-24DC-UT-I	2906834	1
TTC-6-TVSD-D-48DC-UT-I	2906835	1
TTC-6-TVSD-D-60DC-UT-I	2906836	1
TTC-6-TVSD-D-24DC-PT-I	2906851	1
TTC-6-TVSD-D-48DC-PT-I	2906852	1
TTC-6-TVSD-D-60DC-PT-I	2906853	1

### Accessories

TTC-6-LCP	2908729	1
TTC-6-FMRS-UT	2907810	1
TTC-6-FMRS-PT	2907811	1

# Surge protection and interference suppression filters

## Surge protection for MCR technology

### Single-stage protective devices TERMITRAB complete

- Medium surge protection for signal circuits on electronic controllers
- Overall width of just 6.2 mm
- With Push-in or screw connection technology
- Integrated mechanical status indicator
- Optional remote signaling module monitors up to 40 items, without additional wiring



new

1-conductor with grounded reference potential



new

2-conductor, floating

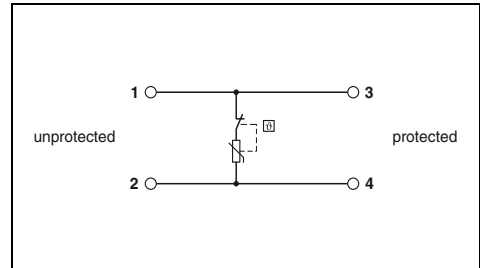
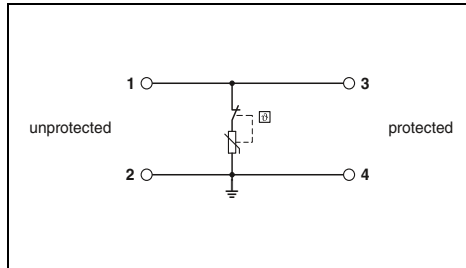

#### Technical data

Electrical data	... 24DC	... 48DC	... 60DC	... 120AC
IEC test classification/EN type	C1 / C2 / C3	C1 / C2 / C3	C1 / C2 / C3	C1 / C2 / C3
Maximum continuous operating voltage $U_C$	30 V DC	60 V DC	75 V DC	/ 150 V AC
Rated current	10 A (60°C)	10 A (60°C)	10 A (60°C)	10 A (60°C)
Nominal discharge current $I_n$ (8/20) $\mu$ s				
Protection level $U_p$	Core-Ground / Core-GND	2 kA / -	2 kA / -	2 kA / -
	Core-Ground	$\leq 80$ V (C3 - 25 A)	$\leq 150$ V (C3 - 25 A)	$\leq 190$ V (C3 - 25 A)
	Core-GND	-	-	-
Cut-off frequency $f_g$ (3 dB)	Asymmetrical in the 150 $\Omega$ system	typ. 200 kHz	typ. 650 kHz	typ. 650 kHz
Resistance per path		100 m $\Omega$	100 m $\Omega$	100 m $\Omega$
General data			6.2 mm / 92 mm / 69.5 mm	6.2 mm / 92 mm / 69.5 mm
Dimensions W/H/D			0.2...4 mm <sup>2</sup> / 0.2...2.5 mm <sup>2</sup> / 24 ... 12	0.2...4 mm <sup>2</sup> / 0.2...2.5 mm <sup>2</sup> / 24 ... 12
Connection data solid/stranded/AWG			-40 °C ... 85 °C	-40 °C ... 85 °C
Temperature range			IEC 61643-21 / EN 61643-21	IEC 61643-21 / EN 61643-21
Test standards				

Technical data	... 24DC	... 48DC	... 60DC	... 120AC
IEC test classification/EN type	C1 / C2 / C3	C1 / C2 / C3	C1 / C2 / C3	C1 / C2 / C3
Maximum continuous operating voltage $U_C$	30 V DC	60 V DC	75 V DC	/ 150 V AC
Rated current	10 A (60°C)	10 A (60°C)	10 A (60°C)	10 A (60°C)
Nominal discharge current $I_n$ (8/20) $\mu$ s				
Protection level $U_p$	Core-Ground / Core-GND	2 kA / -	2 kA / -	2.5 kA / -
	Core-Ground	$\leq 80$ V (C3 - 25 A)	$\leq 150$ V (C3 - 25 A)	$\leq 380$ V (C3 - 25 A)
	Core-GND	-	-	-
Cut-off frequency $f_g$ (3 dB)	Asymmetrical in the 150 $\Omega$ system	typ. 200 kHz	typ. 650 kHz	typ. 1 MHz
Resistance per path		100 m $\Omega$	100 m $\Omega$	100 m $\Omega$
General data			6.2 mm / 92 mm / 69.5 mm	6.2 mm / 92 mm / 69.5 mm
Dimensions W/H/D			0.2...4 mm <sup>2</sup> / 0.2...2.5 mm <sup>2</sup> / 24 ... 12	0.2...4 mm <sup>2</sup> / 0.2...2.5 mm <sup>2</sup> / 24 ... 12
Connection data solid/stranded/AWG			-40 °C ... 85 °C	-40 °C ... 85 °C
Temperature range			IEC 61643-21 / EN 61643-21	IEC 61643-21 / EN 61643-21
Test standards				

#### Ordering data

Description	Voltage $U_N$
<b>TERMITRAB complete, with screw connection technology</b>	
	24 V DC
	48 V DC
	60 V DC
	120 V AC
<b>TERMITRAB complete, with Push-in connection technology</b>	
	24 V DC
	48 V DC
	60 V DC
	120 V AC

Type	Order No.	Pcs./Pkt.
TTC-6-MOV-C-24DC-UT-I	2906837	1
TTC-6-MOV-C-48DC-UT-I	2906838	1
TTC-6-MOV-C-60DC-UT-I	2906839	1
TTC-6-MOV-C-120AC-UT-I	2906840	1
TTC-6-MOV-C-24DC-PT-I	2906854	1
TTC-6-MOV-C-48DC-PT-I	2906855	1
TTC-6-MOV-C-60DC-PT-I	2906857	1
TTC-6-MOV-C-120AC-PT-I	2906858	1

#### Ordering data

Type	Order No.	Pcs./Pkt.
TTC-6-MOV-D-24DC-UT-I	2906841	1
TTC-6-MOV-D-24DC-PT-I	2906859	1

#### Accessories

End cover	TTC-6-LCP	2908729	1
Remote signaling set	TTC-6-FMRS-UT	2907810	1
Screw connection technology	TTC-6-FMRS-PT	2907811	1
Push-in connection technology			

Accessories	TTC-6-LCP	2908729	1
Remote signaling set	TTC-6-FMRS-UT	2907810	1
Screw connection technology	TTC-6-FMRS-PT	2907811	1
Push-in connection technology			

#### Accessories

Accessories	TTC-6-LCP	2908729	1
Remote signaling set	TTC-6-FMRS-UT	2907810	1
Screw connection technology	TTC-6-FMRS-PT	2907811	1
Push-in connection technology			

### Single-stage protective devices TERMITRAB complete

- Coarse surge protection, right at the building entrance, with an MCR cable
- Overall width of just 6.2 mm
- With Push-in or screw connection technology
- Integrated mechanical status indicator
- Optional remote signaling module monitors up to 40 items, without additional wiring



1-conductor with grounded reference potential



2-conductor, floating

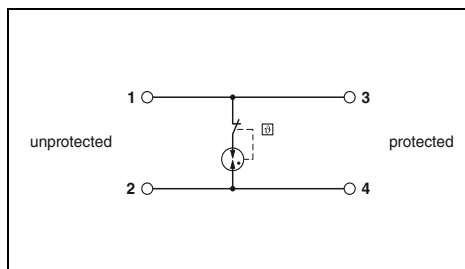
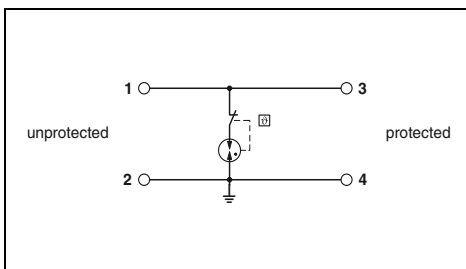

#### Technical data

Electrical data	... 24AC	... 110AC
IEC test classification/EN type	C1 / C2 / C3 / D1	C1 / C2 / C3 / D1
Maximum continuous operating voltage $U_C$	- / 36 V AC	- / 130 V AC
Rated current	2 A (60°C)	2 A (60°C)
Pulse discharge current $I_{imp}$ (10/350) $\mu$ s	0.5 kA	0.5 kA
Nominal discharge current $I_n$ (8/20) $\mu$ s		
Protection level $U_p$	Core-Ground / Core-GND	Core-Ground / Core-GND
	Core-Ground	Core-Ground
	Core-GND	Core-GND
	$\leq 900$ V (C3 - 100 A)	$\leq 900$ V (C3 - 100 A)
	-	-
Cut-off frequency $f_g$ (3 dB)	Asymmetrical in the 150 $\Omega$ system	Asymmetrical in the 150 $\Omega$ system
	typ. 25 MHz	typ. 25 MHz
Resistance per path	100 m $\Omega$	100 m $\Omega$
General data		
Dimensions W/H/D	6.2 mm / 92 mm / 69.5 mm	
Connection data solid/stranded/AWG	0.2...4 mm <sup>2</sup> / 0.2...2.5 mm <sup>2</sup> / 24 ... 12	
Temperature range	-40 °C ... 85 °C	
Test standards	IEC 61643-21 / EN 61643-21	

Electrical data	... 24AC	... 60AC
IEC test classification/EN type	C1 / C2 / C3 / D1	C1 / C2 / C3 / D1
Maximum continuous operating voltage $U_C$	- / 30 V AC	- / 75 V AC
Rated current	2 A (60°C)	2 A (60°C)
Pulse discharge current $I_{imp}$ (10/350) $\mu$ s	-	-
Nominal discharge current $I_n$ (8/20) $\mu$ s	-	-
Protection level $U_p$	Core-Ground / Core-GND	Core-Ground / Core-GND
	Core-Ground	Core-Ground
	Core-GND	Core-GND
	$\leq 800$ V (C3 - 25 A)	$\leq 800$ V (C3 - 25 A)
	-	-
Cut-off frequency $f_g$ (3 dB)	Asymmetrical in the 150 $\Omega$ system	Asymmetrical in the 150 $\Omega$ system
	typ. 25 MHz	typ. 25 MHz
Resistance per path	100 m $\Omega$	100 m $\Omega$
General data		
Dimensions W/H/D	6.2 mm / 92 mm / 69.5 mm	
Connection data solid/stranded/AWG	0.2...4 mm <sup>2</sup> / 0.2...2.5 mm <sup>2</sup> / 24 ... 12	
Temperature range	-40 °C ... 85 °C	
Test standards	IEC 61643-21 / EN 61643-21	

#### Ordering data

Description	Voltage $U_N$
<b>TERMITRAB complete</b> , with screw connection technology	24 V AC 60 V AC 110 V AC
<b>TERMITRAB complete</b> , with Push-in connection technology	24 V AC 60 V AC 110 V AC

Type	Order No.	Pcs./Pkt.
TTC-6-GDT-C-24AC-UT-I	2906842	1
TTC-6-GDT-C-110AC-UT-I	2906844	1
TTC-6-GDT-C-24AC-PT-I	2906860	1
TTC-6-GDT-C-110AC-PT-I	2906861	1

#### Ordering data

Type	Order No.	Pcs./Pkt.
TTC-6-GDT-D-24AC-UT-I	2906845	1
TTC-6-GDT-D-60AC-UT-I	2906846	1
TTC-6-GDT-D-24AC-PT-I	2906862	1
TTC-6-GDT-D-60AC-PT-I	2906863	1

#### Accessories

<b>End cover</b>
<b>Remote signaling set</b>
Screw connection technology
Push-in connection technology

Type	Order No.	Pcs./Pkt.
TTC-6-LCP	2908729	1
TTC-6-FMRS-UT	2907810	1
TTC-6-FMRS-PT	2907811	1

#### Accessories

Type	Order No.	Pcs./Pkt.
TTC-6-LCP	2908729	1
TTC-6-FMRS-UT	2907810	1
TTC-6-FMRS-PT	2907811	1

# Surge protection and interference suppression filters

## Surge protection for MCR technology

### Potentially explosive applications TERMITRAB complete

- One-piece or pluggable surge protection
- Tailored to the special requirements of intrinsically safe circuits
- Overall width of just 6.2 mm
- With screw connection technology
- Integrated mechanical status indicator
- With knife disconnection
- Impedance-neutral insertion and removal
- Coded connector versions
- Plugs can be tested with CHECKMASTER 2

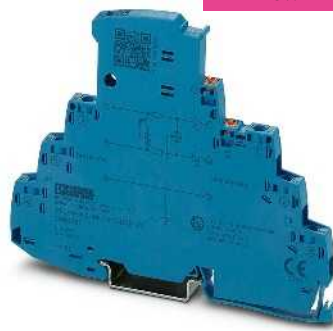

new

Double wire (loop), floating, intrinsically safe, one-piece e.g., for 4 ... 20 mA current loop

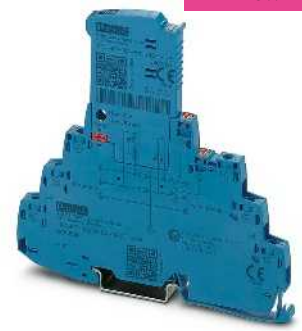

new

Double wire (loop), floating, intrinsically safe, pluggable, e.g., for 4 ... 20 mA current loop

Ex:

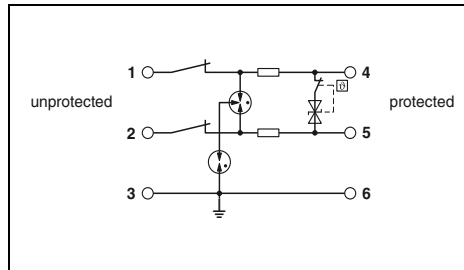

Ex:

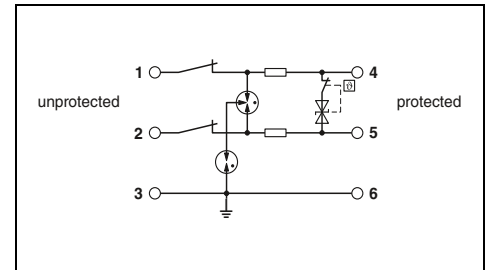

#### Technical data

Electrical data	... 24DC
IEC test classification/EN type	C1 / C2 / C3 / D1
Maximum continuous operating voltage $U_C$	30 V DC
Rated current	600 mA (40°C)
Pulse discharge current $I_{imp}$ (10/350) $\mu$ s	0.5 kA
Nominal discharge current $I_n$ (8/20) $\mu$ s	
	Core-Core / Core-Ground
Total discharge current $I_{total}$ (8/20) $\mu$ s	5 kA / 5 kA
Protection level $U_p$	10 kA
	Core-Core
	Core-Ground
	$\leq 55$ V (C3 - 100 A)
	$\leq 1.4$ kV (C3 - 100 A)
Cut-off frequency $f_g$ (3 dB)	
	Symmetrical in the 150 $\Omega$ system
Resistance per path	typ. 940 kHz
	1.65 $\Omega$
General data	
Dimensions W/H/D	6.2 mm / 105.8 mm / 83.5 mm
Connection data solid/stranded/AWG	0.2...4 mm <sup>2</sup> / 0.2...2.5 mm <sup>2</sup> / 24 ... 12
Temperature range	-40 °C ... 85 °C
Test standards	EN 60079-0 / EN 60079-11 / EN 61643-21 / IEC 60079-0 / IEC 60079-11 / IEC 61643-21

Electrical data	... 24DC
IEC test classification/EN type	C1 / C2 / C3 / D1
Maximum continuous operating voltage $U_C$	30 V DC
Rated current	600 mA (40°C)
Pulse discharge current $I_{imp}$ (10/350) $\mu$ s	0.5 kA
Nominal discharge current $I_n$ (8/20) $\mu$ s	
	Core-Core / Core-Ground
Total discharge current $I_{total}$ (8/20) $\mu$ s	5 kA / 5 kA
Protection level $U_p$	10 kA
	Core-Core
	Core-Ground
	$\leq 55$ V (C3 - 100 A)
	$\leq 1.4$ kV (C3 - 100 A)
Cut-off frequency $f_g$ (3 dB)	
	Symmetrical in the 150 $\Omega$ system
Resistance per path	typ. 940 kHz
	1.65 $\Omega$
General data	
Dimensions W/H/D	6.2 mm / 105.8 mm / 100 mm
Connection data solid/stranded/AWG	0.2...4 mm <sup>2</sup> / 0.2...2.5 mm <sup>2</sup> / 24 ... 12
Temperature range	-40 °C ... 85 °C
Test standards	EN 60079-0 / EN 60079-11 / EN 61643-21 / IEC 60079-0 / IEC 60079-11 / IEC 61643-21

#### Ordering data

Description	Voltage $U_N$	Type	Order No.	Pcs./Pkt.
TERMITRAB complete, with screw connection technology	24 V DC	TTC-6-1X2-M-EX-24DC-UT-I	2906820	1

#### Ordering data

Description	Voltage $U_N$	Type	Order No.	Pcs./Pkt.
TERMITRAB complete, with screw connection technology	24 V DC	TTC-6P-1X2-M-EX-24DC-UT-I	2906824	1

### Potentially explosive applications PLUGTRAB PT-IQ

- Tailored to the special requirements of intrinsically safe circuits
- Multi-stage status monitoring
- Group message via supply and remote signaling module
- Multi-stage, floating remote signaling
- System supplied via DIN rail bus
- Up to 10 protection modules per supply module
- Maximum ease of maintenance thanks to the two-piece design
- Plugs are coded
- Impedance-neutral disconnection of plug for maintenance purposes
- Base element remains an integral part of the installation
- Corresponding replacement plugs can be found on our website



Double wire (loop), floating, connection 9/10 grounded directly, e.g., for 4 ... 20 mA current loop

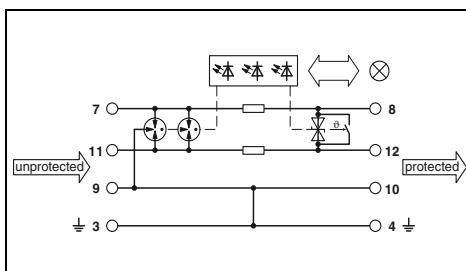

#### Technical data

Electrical data	... 24DC
IEC test classification/EN type	C1 / C2 / C3 / D1
Maximum continuous operating voltage $U_C$	30 V DC / 21 V AC
Rated current	350 mA
Pulse discharge current $I_{imp}$ (10/350) $\mu$ s	2 kA
Nominal discharge current $I_n$ (8/20) $\mu$ s	
Total discharge current $I_{total}$ (8/20) $\mu$ s	Core-Core / Core-Ground 10 kA / 10 kA
Protection level $U_p$	20 kA
	Core-Core $\leq 50$ V (C3 - 25 A)
	Core-Ground $\leq 1.3$ kV (C3 - 100 A)
Cut-off frequency $f_g$ (3 dB)	typ. 1.1 MHz
Resistance per path	1.2 $\Omega$
Symmetrical in the 150 $\Omega$ system	
General data	
Dimensions W/H/D	17.7 mm / 91.1 mm / 77.5 mm
Connection data solid/stranded/AWG	0.2...4 mm <sup>2</sup> / 0.2...2.5 mm <sup>2</sup> / 24 ... 12
Temperature range	-40 °C ... 70 °C
Test standards	EN 61643-21/A2 / IEC 61643-21/A2 / EN 61000-6-2 / EN 61000-6-3/A1

#### Ordering data

Description	Voltage $U_N$
MCR-PLUGTRAB, with screw connection technology	24 V DC

#### Accessories

Replacement plug	Order No.	Pcs./Pkt.
24 V DC		
PLUGTRAB, supply and remote signaling module	2801514	1
Screw connection technology	2800768	1



2 double wires (loops), floating, connection 9/10 grounded directly, e.g., for 4 ... 20 mA current loop

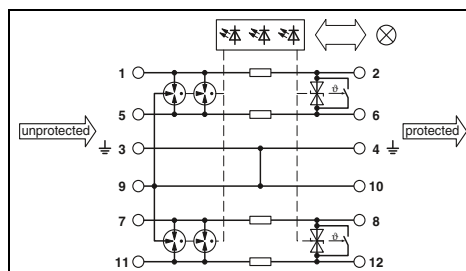

#### Technical data

Electrical data	... 24DC
IEC test classification/EN type	C1 / C2 / C3 / D1
Maximum continuous operating voltage $U_C$	30 V DC / 21 V AC
Rated current	350 mA
Pulse discharge current $I_{imp}$ (10/350) $\mu$ s	2 kA
Nominal discharge current $I_n$ (8/20) $\mu$ s	
Total discharge current $I_{total}$ (8/20) $\mu$ s	Core-Core / Core-Ground 10 kA / 10 kA
Protection level $U_p$	20 kA
	Core-Core $\leq 50$ V (C3 - 25 A)
	Core-Ground $\leq 1.3$ kV (C3 - 100 A)
Cut-off frequency $f_g$ (3 dB)	typ. 1.1 MHz
Resistance per path	1.2 $\Omega$
Symmetrical in the 150 $\Omega$ system	
General data	
Dimensions W/H/D	17.7 mm / 91.1 mm / 77.5 mm
Connection data solid/stranded/AWG	0.2...4 mm <sup>2</sup> / 0.2...2.5 mm <sup>2</sup> / 24 ... 12
Temperature range	-40 °C ... 70 °C
Test standards	EN 61643-21 / IEC 61643-21 / EN 61000-6-2 / EN 61000-6-3/A1

#### Ordering data

Description	Voltage $U_N$
MCR-PLUGTRAB, with screw connection technology	24 V DC

#### Accessories

Replacement plug	Order No.	Pcs./Pkt.
24 V DC		
PLUGTRAB, supply and remote signaling module	2801515	1
Screw connection technology	2800768	1

# Surge protection and interference suppression filters

## Surge protection for MCR technology

### Potentially explosive applications SURGETRAB S-PT

- Arresters in hexagonal tube with various outer threads
- **S-PT-EX(I)...** installation in the signal path feed-through
- **S-PT-EX, S-PT-2xEX...** installation in a separate cable gland parallel to the signal lines



Double wire (loop), intrinsically safe, e.g., for 4 ... 20 mA current loops



Double wire (loop), floating, intrinsically safe, encapsulated, without decoupling resistance

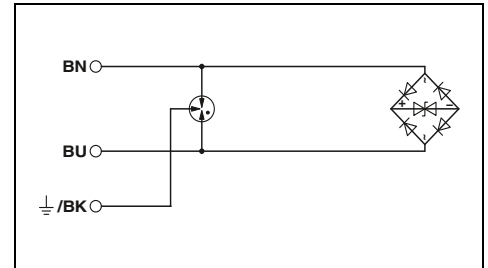
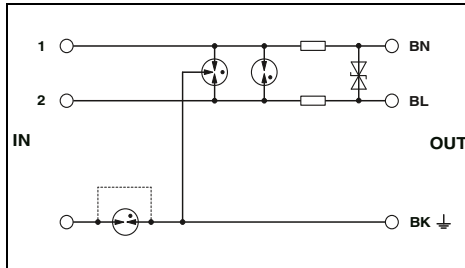

#### Technical data

Electrical data	... 24DC
IEC test classification/EN type	C1 / C2 / C3 / D1
Maximum continuous operating voltage $U_C$	30 V DC / 21 V AC
Rated current	350 mA (50 °C)
Pulse discharge current $I_{imp}$ (10/350) $\mu$ s	1 kA
Nominal discharge current $I_n$ (8/20) $\mu$ s	
	Core-Core / Core-Ground
Maximum permitted short-circuit current at installation location	10 kA / 10 kA
Total discharge current $I_{total}$ (8/20) $\mu$ s	350 mA
Max. discharge current $I_{max}$ (8/20) $\mu$ s	-
Protection level $U_p$	10 kA
	Core-Core
	Core-Ground
Output voltage limitation at 1 kV/ $\mu$ s	$\leq 50$ V (C3 - 25 A)
	$\leq 1.4$ kV (C3 - 100 A)
	Core-Core / Core-Ground
Resistance per path	$\leq 50$ V / $\leq 1.4$ kV (Direct grounding)
	2.2 $\Omega$

#### General data

Dimensions W/H/D	34 mm / 34 mm / 137 mm
Temperature range	-40 °C ... 50 °C
Test standards	EN 61643-21/A2 / EN 60079-0 / EN 60079-11 / EN 60079-26 / IEC 60079-0 / IEC 60079-11

#### Safety data

EC-type examination certificate according to ATEX	KEMA 06ATEX0002
Identification according to ATEX	Ex II 1G Ex ia IIC T4...T6 Ga
Maximum internal capacitance $C_i$	2 nF
Maximum internal inductance $L_i$	1 $\mu$ H
Maximum input current $I_i$	350 mA (T4, T5, T6 / $\leq 50$ °C)
Maximum input voltage $U_i$	30 V
Maximum input power $P_i$	3 W

#### Ordering data

Description	Voltage $U_N$
<b>SURGETRAB</b> protective adapter for installation on measuring sensors for Ex protection zones	
Outer thread: M20 x 1.5	24 V DC
Outer thread: 1/2" 14 NPT	24 V DC
Outer thread: 3/4" 14 NPT	24 V DC
Outer thread: M20 x 1.5	48 V DC
Outer thread: 1/2" 14 NPT	48 V DC

#### Technical data

... 24DC	... 48DC
C1 / C2 / C3 / D1	C1 / C2 / C3 / D1
36 V DC / 25 V AC	53 V DC / 37 V AC
-	-
1 kA	1 kA
260 A / 10 kA	170 A / 10 kA
1 A (non-Ex)	1 A (non-Ex)
20 kA	20 kA
-	-
$\leq 65$ V (C3 - 10 A)	$\leq 90$ V (C3 - 10 A)
$\leq 1.1$ kV (C3 - 100 A)	$\leq 1.1$ kV (C3 - 100 A)
$\leq 60$ V / -	$\leq 80$ V / -
-	-

#### General data

Dimensions W/H/D	28 mm / 28 mm / 79 mm
Temperature range	-40 °C ... 80 °C (non-Ex)
Test standards	EN 61643-21/A2 / EN 60079-0 / EN 60079-1 / EN 60079-11 / EN 60079-26 / EN 60079-31

#### Safety data

EC-type examination certificate according to ATEX	KEMA 09ATEX0028 X
Identification according to ATEX	Ex II 1 G Ex ia IIC T4...T6
Maximum internal capacitance $C_i$	1.65 nF
Maximum internal inductance $L_i$	1.14 nF
Maximum input current $I_i$	1 $\mu$ H
Maximum input voltage $U_i$	500 mA (T4 / $\leq 75$ °C)
Maximum input power $P_i$	500 mA (T4 / $\leq 75$ °C)
	36 V DC
	53 V DC
	3 W

#### Ordering data

Type	Order No.	Pcs./Pkt.
S-PT-EX-24DC	2800034	1
S-PT-EX-24DC-1/2"	2800035	1
S-PT-EX-48DC	2800053	1
S-PT-EX-48DC-1/2"	2800054	1



**2 double wires (loops), floating, intrinsically safe, encapsulated, without decoupling resistance**

ERC

Ex:

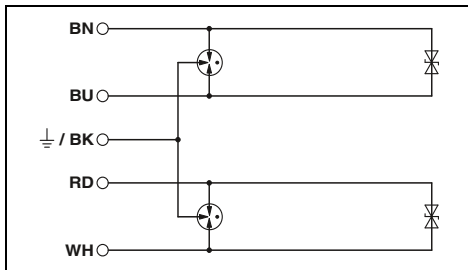

**Technical data**

... 24DC	... 48DC
C1 / C2 / C3 / D1	C1 / C2 / C3 / D1
36 V DC / 25 V AC	53 V DC / 37 V AC
-	-
1 kA	1 kA
260 A / 10 kA	170 A / 10 kA
1 A (non-Ex)	1 A (non-Ex)
20 kA	20 kA
-	-
≤ 50 V (C3 - 10 A)	≤ 80 V (C3 - 10 A)
≤ 1.1 kV (C3 - 100 A)	≤ 1.1 kV (C3 - 100 A)
≤ 50 V / -	≤ 80 V / -
-	-

28 mm / 28 mm / 79 mm

-40 °C ... 80 °C (non-Ex)

EN 61643-21/A2 / EN 60079-0 / EN 60079-1 /

EN 60079-11 / EN 60079-26 / EN 60079-31

KEMA 09ATEX0028 X	KEMA 09ATEX0028 X
II 1 G Ex ia IIC T4...T6	II 1 G Ex ia IIC T4...T6
II 2 G Ex d IIC T4...T6	II 2 G Ex d IIC T4...T6
1.65 nF	1.14 nF
1 μH	1 μH
500 mA (T4 / ≤ 75 °C)	500 mA (T4 / ≤ 75 °C)
36 V DC	53 V DC
3 W	3 W

**Ordering data**

Type	Order No.	Pcs./Pkt.
S-PT-2XEX-24DC	2800040	1
S-PT-2XEX-24DC-1/2"	2800041	1
S-PT-2XEX-48DC	2800038	1
S-PT-2XEX-48DC-1/2"	2800039	1

## Surge protection for MCR technology

### Potentially explosive applications PLUGTRAB PT

- Tailored to the special requirements of intrinsically safe circuits
- Consistently pluggable signal circuit protection
- Maximum ease of maintenance thanks to the two-piece design
- Base element remains an integral part of the installation
- Impedance-neutral disconnection of plug for test and maintenance purposes
- Plugs can be checked with CHECKMASTER

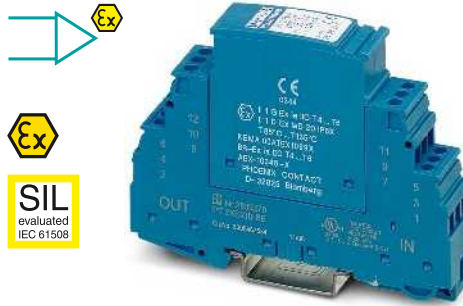

2 double wires (loops), intrinsically safe,  
e.g., for 4 ... 20 mA current loops

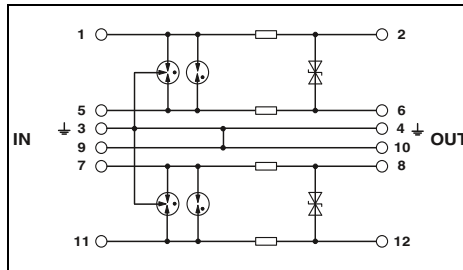

#### Technical data

<b>Electrical data</b>		
IEC test classification/EN type		C1 / C2 / C3 / D1
Maximum continuous operating voltage $U_C$		30 V DC / 21 V AC
Rated current		325 mA (40°C)
Pulse discharge current $I_{imp}$ (10/350) $\mu$ s		2 kA
Nominal discharge current $I_n$ (8/20) $\mu$ s		
	Core-Core / Core-Ground	10 kA / 10 kA
Total discharge current $I_{total}$ (8/20) $\mu$ s		20 kA
Max. discharge current $I_{max}$ (8/20) $\mu$ s		20 kA (in total)
Protection level $U_p$		
	Core-Core	$\leq 50$ V (C3 - 25 A)
	Core-Ground	$\leq 1$ kV (C2 - 10 kV / 5 kA)
Output voltage limitation at 1 kV/ $\mu$ s		
	Core-Core / Core-Ground	$\leq 45$ V / $\leq 1$ kV
Cut-off frequency $f_g$ (3 dB)		
	Symmetrical in the 50 $\Omega$ system	typ. 4.5 MHz
Resistance per path		2.2 $\Omega$
<b>General data</b>		
Dimensions W/H/D		17.7 mm / 90 mm / 65.5 mm
Connection data solid/stranded/AWG		0.2...4 mm <sup>2</sup> / 0.2...2.5 mm <sup>2</sup> / 24 ... 12
Temperature range		-40 °C ... 85 °C
Test standards		EN 61643-21 / EN 60079-0 / EN 60079-11 / EN 60079-26 / IEC 60079-0 / IEC 60079-11
<b>Safety data</b>		
EC-type examination certificate according to ATEX		KEMA 00ATEX1099 X
Identification according to ATEX		Ex II 1G Ex ia IIC T4...T6 Ga Ex II 1D Ex ia IIIC T135°C...T85°C Da
Maximum internal capacitance $C_i$		1.3 nF
Maximum internal inductance $L_i$		1 $\mu$ H
Maximum input current $I_i$		325 mA (T4 / $\leq 80^\circ$ C)
Maximum input voltage $U_i$		30 V DC
Maximum input power $P_i$		3 W

#### Ordering data

Description	Voltage $U_N$	Type	Order No.	Pcs./Pkt.
PLUGTRAB plug, with protective circuit for plugging into the PT base element	24 V DC	PT 2XEX(I)-24DC-ST	2838225	10
PLUGTRAB base element, for mounting on NS 35	24 V DC	PT 2XEX(I)-BE	2839279	10

#### Accessories

Shield fast connection			
For $\varnothing$ 3-6 mm		SSA 3-6	2839295 10
For $\varnothing$ 5-10 mm		SSA 5-10	2839512 10

### Potentially explosive applications TERMITRAB complete

- One-piece or pluggable surge protection
- Tailored to the special requirements of intrinsically safe circuits
- Overall width of just 6.2 mm
- With screw connection technology
- Integrated mechanical status indicator
- With knife disconnection
- Impedance-neutral insertion and removal
- Coded connector versions
- Plugs can be tested with CHECKMASTER 2



new

2-conductor with common reference potential, intrinsically safe, one-piece, e.g., for binary signals

Ex:

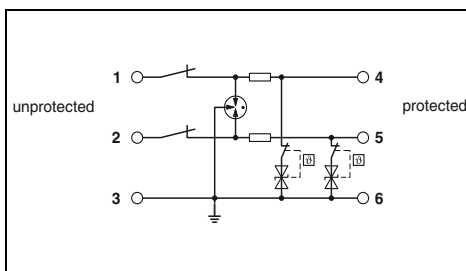

#### Technical data

Electrical data	
IEC test classification/EN type	C1 / C2 / C3 / D1
Maximum continuous operating voltage $U_C$	30 V DC
Rated current	600 mA (40°C)
Pulse discharge current $I_{imp}$ (10/350) $\mu$ s	0.5 kA
Nominal discharge current $I_n$ (8/20) $\mu$ s	
	Core-Core / Core-Ground
Total discharge current $I_{total}$ (8/20) $\mu$ s	- / 5 kA
Protection level $U_p$	10 kA
	Core-Core
	Core-Ground
	-
	$\leq 50$ V (C3 - 100 A)
Cut-off frequency $f_g$ (3 dB)	
	Symmetrical in the 150 $\Omega$ system
	-
Resistance per path	1.65 $\Omega$
General data	
Dimensions W/H/D	6.2 mm / 105.8 mm / 83.5 mm
Connection data solid/stranded/AWG	0.2...4 mm <sup>2</sup> / 0.2...2.5 mm <sup>2</sup> / 24 ... 12
Temperature range	-40 °C ... 85 °C
Test standards	EN 60079-0 / EN 60079-11 / EN 61643-21 / IEC 60079-0 / IEC 60079-11 / IEC 61643-21

#### Ordering data

Description	Voltage $U_N$	Type	Order No.	Pcs./Pkt.
TERMITRAB complete, with screw connection technology	24 V DC	TTC-6-2X1-M-EX-24DC-UT-I	2906821	1

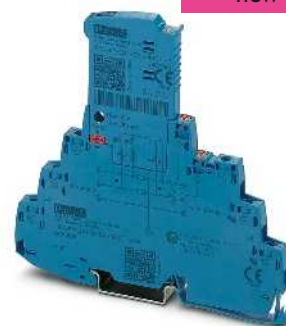

new

2-conductor with common reference potential, intrinsically safe, pluggable, e.g., for binary signals

Ex:

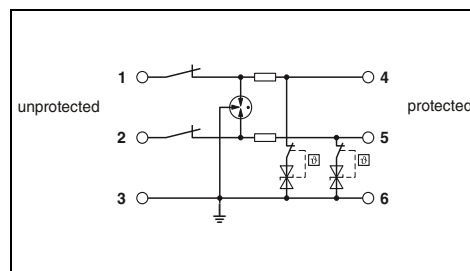

#### Technical data

Electrical data	
IEC test classification/EN type	C1 / C2 / C3 / D1
Maximum continuous operating voltage $U_C$	30 V DC
Rated current	600 mA (40°C)
Pulse discharge current $I_{imp}$ (10/350) $\mu$ s	0.5 kA
Nominal discharge current $I_n$ (8/20) $\mu$ s	
	Core-Core / Core-Ground
Total discharge current $I_{total}$ (8/20) $\mu$ s	- / 5 kA
Protection level $U_p$	10 kA
	Core-Core
	Core-Ground
	-
	$\leq 50$ V (C3 - 100 A)
Cut-off frequency $f_g$ (3 dB)	
	Symmetrical in the 150 $\Omega$ system
	-
Resistance per path	1.65 $\Omega$
General data	
Dimensions W/H/D	6.2 mm / 105.8 mm / 100 mm
Connection data solid/stranded/AWG	0.2...4 mm <sup>2</sup> / 0.2...2.5 mm <sup>2</sup> / 24 ... 12
Temperature range	-40 °C ... 85 °C
Test standards	EN 60079-0 / EN 60079-11 / EN 61643-21 / IEC 60079-0 / IEC 60079-11 / IEC 61643-21

#### Ordering data

Description	Voltage $U_N$	Type	Order No.	Pcs./Pkt.
TERMITRAB complete, with screw connection technology	24 V DC	TTC-6P-2X1-M-EX-24DC-UT-I	2906825	1

# Surge protection and interference suppression filters

## Surge protection for MCR technology

### Potentially explosive applications PLUGTRAB PT

- Tailored to the special requirements of intrinsically safe circuits
- Consistently pluggable signal circuit protection
- Maximum ease of maintenance thanks to the two-piece design
- Base element remains an integral part of the installation
- Impedance-neutral disconnection of plug for test and maintenance purposes
- Plugs can be checked with CHECKMASTER



4-wire, intrinsically safe, impedance-free,  
e.g., for temperature measurements

#### Notes:

For approvals and dimensional drawing, visit  
[phoenixcontact.net/products](http://phoenixcontact.net/products)

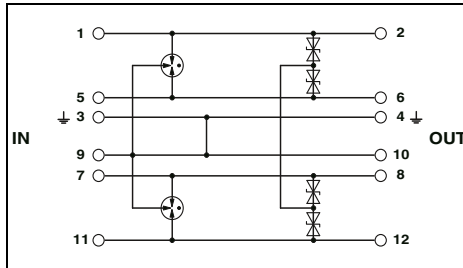

#### Technical data

Electrical data		
IEC test classification/EN type		C1 / C2 / C3 / D1
Maximum continuous operating voltage $U_C$		30 V DC / 21 V AC
Rated current		500 mA (40°C)
Pulse discharge current $I_{imp}$ (10/350) $\mu$ s		1 kA
Nominal discharge current $I_n$ (8/20) $\mu$ s		
	Core-Core / Core-Ground	308 A / 10 kA
Total discharge current $I_{total}$ (8/20) $\mu$ s		20 kA
Max. discharge current $I_{max}$ (8/20) $\mu$ s		20 kA (in total)
Protection level $U_p$	Core-Core	$\leq 50$ V (C3 - 25 A)
	Core-Ground	$\leq 1$ kV (C2 - 10 kV / 5 kA)
Output voltage limitation at 1 kV/ $\mu$ s	Core-Core / Core-Ground	$\leq 45$ V / $\leq 1$ kV
Cut-off frequency $f_g$ (3 dB)	Symmetrical in the 50 $\Omega$ system	typ. 7 MHz
Resistance per path		0 $\Omega$
General data		
Dimensions W/H/D		17.7 mm / 90 mm / 65.5 mm
Connection data solid/stranded/AWG		0.2...4 mm <sup>2</sup> / 0.2...2.5 mm <sup>2</sup> / 24 ... 12
Temperature range		-40 °C ... 85 °C
Test standards		EN 61643-21 / EN 60079-0 / EN 60079-11 / EN 60079-26 / IEC 60079-0 / IEC 60079-11
Safety data		
EC-type examination certificate according to ATEX		KEMA 00ATEX1099 X
Identification according to ATEX		Ex II 1G Ex ia IIC T4...T6 Ga Ex II 1D Ex ia IIIC T135°C...T85°C Da
Maximum internal capacitance $C_i$		1.1 nF
Maximum internal inductance $L_i$		1 $\mu$ H
Maximum input current $I_i$		500 mA (T4 / $\leq 80^\circ$ C)
Maximum input voltage $U_i$		30 V DC
Maximum input power $P_i$		850 mW (T4 / $\leq 80^\circ$ C)

#### Ordering data

Description	Voltage $U_N$	Type	Order No.	Pcs./Pkt.
PLUGTRAB plug, with protective circuit for plugging into the PT base element	24 V DC	PT 4-EX(I)-24DC-ST	2839253	10
PLUGTRAB base element, for mounting on NS 35	24 V DC	PT 4-EX(I)-BE	2839486	10

#### Accessories

Shield fast connection	Order No.	Pcs./Pkt.
For $\varnothing$ 3-6 mm	2839295	10
For $\varnothing$ 5-10 mm	2839512	10

**Potentially explosive applications**  
**SURGETRAB S-PT**

- Arresters in hexagonal tube with various outer threads
- **S-PT-4-EX** installation in a separate cable gland parallel to the signal cables
- S-PT-EX... devices are approved for Ex i and Ex d measuring probes



**4-wire with common reference potential, intrinsically safe, encapsulated, without decoupling resistance**

ERC  
Ex:

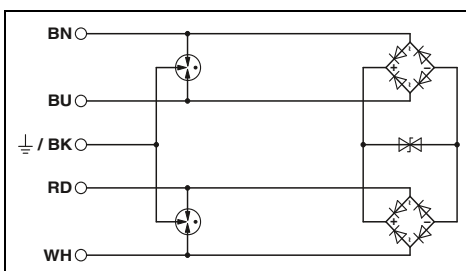

**Technical data**

Electrical data	
IEC test classification/EN type	C1 / C2 / C3 / D1
Maximum continuous operating voltage $U_C$	36 V DC / 25 V AC
Pulse discharge current $I_{imp}$ (10/350) $\mu$ s	1 kA
Nominal discharge current $I_n$ (8/20) $\mu$ s	
Core-Core / Core-Ground	260 A / 10 kA
Maximum permitted short-circuit current at installation location	1 A (non-Ex)
Total discharge current $I_{total}$ (8/20) $\mu$ s	20 kA
Max. discharge current $I_{max}$ (8/20) $\mu$ s	-
Protection level $U_p$	
Core-Core	$\leq 65$ V (C3 - 10 A)
Core-Ground	$\leq 1.1$ kV (C3 - 100 A)
Output voltage limitation at 1 kV/ $\mu$ s	
Core-Core / Core-Ground	$\leq 60$ V / -
General data	
Dimensions W/H/D	28 mm / 28 mm / 79 mm
Temperature range	-40 °C ... 80 °C (non-Ex)
Test standards	EN 61643-21/A2 / EN 60079-0 / EN 60079-1 / EN 60079-11 / EN 60079-26 / EN 60079-31
Safety data	
EC-type examination certificate according to ATEX	KEMA 09ATEX0028 X
Identification according to ATEX	II 1 G Ex ia IIC T4...T6 II 2 G Ex d IIC T4...T6
Maximum internal capacitance $C_i$	1.65 nF
Maximum internal inductance $L_i$	1 $\mu$ H
Maximum input current $I_i$	500 mA (T4 / $\leq 75$ °C)
Maximum input voltage $U_i$	36 V DC
Maximum input power $P_i$	3 W

**Ordering data**

Description	Voltage $U_N$	Type	Order No.	Pcs./Pkt.
<b>SURGETRAB</b> protective adapter for installation on measuring sensors for Ex protection zones				
Outer thread: M20 x 1.5	24 V DC	<b>S-PT-4-EX-24DC</b>	<b>2800036</b>	1
Outer thread: 1/2" 14 NPT	24 V DC	<b>S-PT-4-EX-24DC-1/2"</b>	<b>2800037</b>	1



Low signal levels at high frequencies require special protective circuits in data processing and telecommunications. The arresters must guarantee short response times to quickly limit the surge voltages to safe values, without impairing signal quality. In addition, the protective devices support system-specific connections, such as RJ45 or D-SUB connectors, and all types of network topology.

#### **DATATRAB DT - the all-round solution for protecting data interfaces**

DATATRAB DT reliably protects high-speed networks against damage caused by surge voltages. DT-LAN-CAT.6+ supports various data protocols at very high transmission speeds, such as Ethernet, Power over Ethernet (PoE), ISDN, token ring, and DS1, in a single device.

The housing has a ground connection snap-on foot into which the ground connection cover with equipotential bonding cable is inserted. DATATRAB can be therefore used either as an adapter or a DIN rail module after removing the ground connection cover.

**i** Your web code: #0145

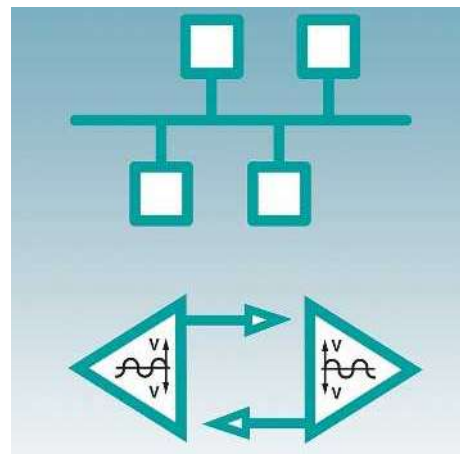

### Versatile

The DATATRAB product range can offer a suitable protective device for many and varied applications. The protective devices are simply installed between the signal paths with interfaces for RJ11/12, RJ45, D-SUB, or screw connection.

### Speed

Used in EDP systems with a transmission speed of up to 10 Gbps (CAT6/CLASS E<sub>o</sub>) and in telecommunications networks with 50 Mbps (VDSL).

### Use

Protective devices suitable for all common applications including Ethernet, token ring, ISDN, DS1, DSL, analog telecommunications, RS-485, V.24, V.11, etc. are available.

The circuit breakers also support Power over Ethernet (PoE) in Mode A and B versions.



### The narrowest surge protection

Starting from a width of 3.5 mm, TERMITRAB complete is the world's narrowest surge protection solution for MCR and fieldbus applications.

### COMTRAB modular

- For protecting telecommunications systems
- Direct insertion in LSA-PLUS marshalling panels
- Coarse protection magazines with gas-filled surge arrester
- Modular miniature connectors with combined coarse and fine protection elements for optimum protection

### Other designs









- Other application-specific protective devices include:
- Two-piece pluggable protective devices in the PLUGTRAB product range
- Combined adapters for the power supply and MAINTRAB interfaces

# Surge protection and interference suppression filters

## Surge protection for information technology and telecommunications

### Selection guide











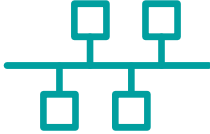







































Explanation of the IEC categories		
LPZ zone	Test category for SPD corresponds to IEC 61643-21	Test class for SPD corresponds to IEC 61643-11
0/1	D1	I
1/2	C2	II
2/3	C1	III

	DIN rail mounting
	Push-in connection
	Screw connection
	Schuko plug-in connection
	RJ45 plug-in connection
	RJ12 plug-in connection
	TAE plug-in connection
	Coaxial plug-in connection
	D-SUB plug-in connection
1)	Also available with screw connection technology



#### Note

Products bearing this stamp (plug elements) can be tested with the CHECKMASTER.

Technology	Interface	Mounting / connection method
	CAN bus / CANopen®	 
	DeviceNet™	 
	Ethernet	 
	GIGABIT ETHERNET (1/10 GBase-T)	 
	FOUNDATION Fieldbus H1	 
	FOUNDATION Fieldbus EX (I)	 
	INTERBUS INLINE (analog I/Os)	  1)
	INTERBUS INLINE (digital I/Os)	  1)
	INTERBUS remote bus	 
	LON (Works)	  1)
	PROFIBUS DP (FMS)	  1)
	PROFIBUS PA (FMS)	 
	PROFINET	 
	RS-422A, V.11, X.27, RS-423A	  1)
	RS-485	  1)
RS-232-C/V.24	   1)	
TTY, 0(4) - 20 mA	 1)	
	ADSL 2+, T-DSL- HDSL, VDSL, analog phone	  1) LSA
	DSL broadband (coax)	 
	ISDN (S <sub>0</sub> & S <sub>2M</sub> bus)	 LSA 
	ISDN (U <sub>k0</sub> )	  / 
		LSA   / 
	SHDSL	  / 

	IEC category	Protected wires	Surge protective device (SPD)	Order No.	Page
	D1/C2/C1	3	PT-IQ-3-HF-12DC-UT	<a href="#">2800786</a>	153
	T3	2	PLT-SEC-T3-24-FM	<a href="#">2905223</a>	71
	D1/C2/C1	3	PT-IQ-3-HF-12DC-UT	<a href="#">2800786</a>	153
	T3	2	PLT-SEC-T3-24-FM	<a href="#">2905223</a>	71
	D1/C2/C1	8	DT-LAN-CAT.6+	<a href="#">2881007</a>	142
	C2/C1	24 x 8	D-LAN-19"-24	<a href="#">2838791</a>	143
	D1/C2/C1	8	DT-LAN-CAT.6+	<a href="#">2881007</a>	142
	D1/C2/C1	4	PT 2X2-FF-ST + PT 4-BE	<a href="#">2800755 + 2839402</a>	161
	D1/C2/C1	2	TTC-6P-1X2-M-EX-24DC-UT-I	<a href="#">2906824</a>	128
	T3	2	PLT-SEC-T3-24-FM	<a href="#">2905223</a>	71
	D1/C2/C1	4	PT-IQ-2X2-24DC-PT	<a href="#">2801263</a>	97
	D1/C2/C1	5	PT-IQ-4X1-24DC-PT	<a href="#">2801271</a>	111
	D1/C2/C1	5	DT-UFB-IB-RBI	<a href="#">2800055</a>	159
		5	DT-UFB-IB-RB0	<a href="#">2800056</a>	159
	D1/C2/C1	2	PT-IQ-1X2-48DC-PT	<a href="#">2801257</a>	96
	D1/C2/C1	3	TTC-6P-3-HF-M-12DC-PT-I	<a href="#">2906756</a>	151
			PT-IQ-3-PB-PT	<a href="#">2801286</a>	146
	C1	2	D-UFB-PB	<a href="#">2880642</a>	155
	D1/C2/C1	2	TTC-6P-3-HF-F-M-EX-24DC-UT-I	<a href="#">2906828</a>	157
		4	PT 4-EX(I)-24DC-ST + PT 4-EX(I)-BE	<a href="#">2839253 + 2839486</a>	134
	D1/C2/C1	8	DT-LAN-CAT.6+	<a href="#">2881007</a>	142
	D1/C2/C1	5	PT-IQ-5-HF+F-12DC-PT	<a href="#">2801295</a>	147
	D1/C2/C1	3	TTC-6P-3-HF-F-M-12DC-PT-I	<a href="#">2906796</a>	151
		5	PT-IQ-5-HF+F-12DC-PT	<a href="#">2801295</a>	147
	D1/C2/C1	5	DT-UFB-485/BS	<a href="#">2920612</a>	147
	C2/C1	9	DT-UFB-V24/S-9-SB	<a href="#">2803069</a>	144
	D1/C2/C1	3	TTC-6P-3-HF-F-M-12DC-PT-I	<a href="#">2906796</a>	151
	D1/C2/C1	4	PT-IQ-2X2-24DC-PT	<a href="#">2801263</a>	97
	D1/C2/C1	4	DT-TELE-RJ45	<a href="#">2882925</a>	162
	D1/C2/C1	2	PT-IQ-1X2-TELE-PT	<a href="#">2801290</a>	163
	D1/C2/C1	2	CTM 1X2-110AC + CTM 10-MAG	<a href="#">2838539 + 2838610</a>	166
	D1/C2/C1	4	TAE-TRAB FM-NFN-AP	<a href="#">2749628</a>	165
	D1/C2/C1 & T3	2	MNT-TEL... / MNT-TAE	<a href="#">2882404 / 2882394</a>	75
	D1/C2/C1	2	C-TV-SAT	<a href="#">2856993</a>	181
	D1/C2/C1 & T3	2	MNT-TV-SAT D/WH	<a href="#">2882297</a>	75
	D1/C2/C1	2 x 2	CTM ISDN (2x) + CTM 10-MAG	<a href="#">2838555 + 2838610</a>	167
	D1/C2/C1	4	DT-LAN-CAT.6+	<a href="#">2881007</a>	142
	D1/C2/C1	4	DT-TELE-RJ45	<a href="#">2882925</a>	162
	D1/C2/C1	2	PT 2-TELE	<a href="#">2882828</a>	164
	D1/C2/C1	2	CTM 1X2-110AC + CTM 10-MAG	<a href="#">2838539 + 2838610</a>	166
	D1/C2/C1 & T3	2	MNT-TEL... / MNT-TAE	<a href="#">2882404 / 2882394</a>	75
	D1/C2/C1	4	DT-TELE-SHDSL	<a href="#">2801593</a>	162

# Surge protection and interference suppression filters

## Surge protection for information technology and telecommunications

### Protection of PROFIBUS DP

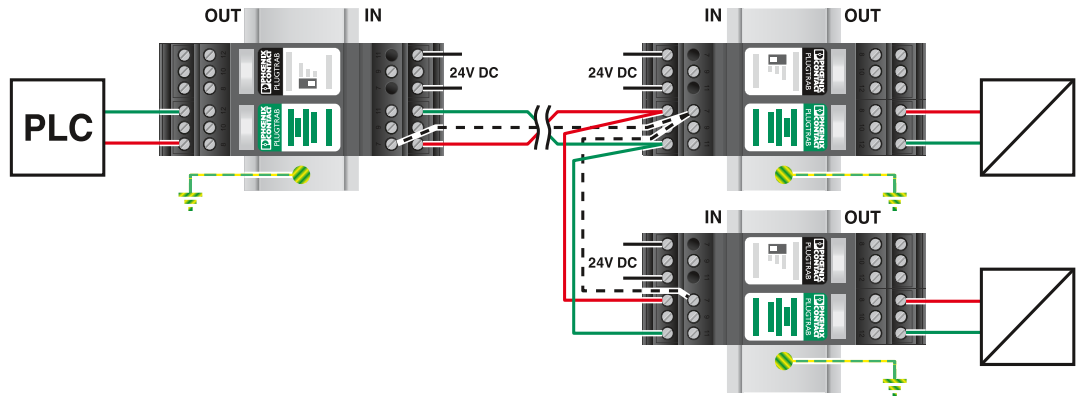
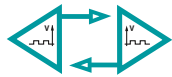

PT-IQ-PTB-PT + PT-IQ-3-PB-PT  
2800768 + 2801286  
Page 153

Optional

PT 5-HF-12DC-ST + PT 2X2-BE  
2838775 + 2839208  
Page 147

### Protection of PROFIBUS PA

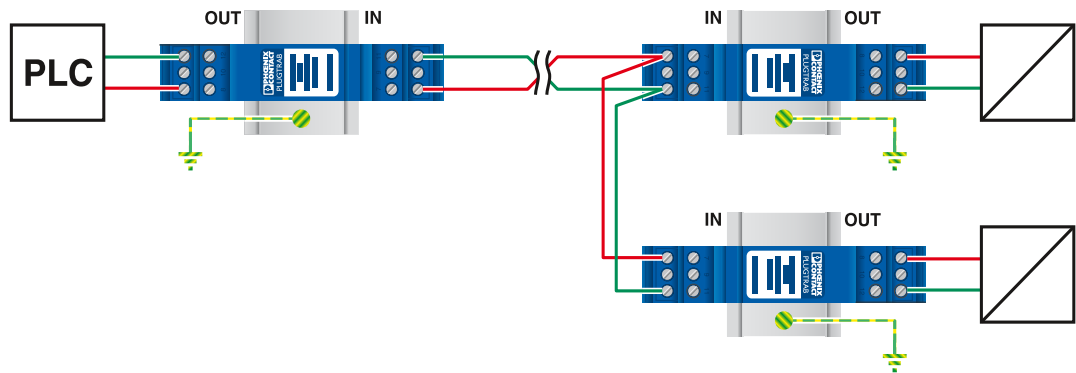
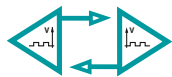

PT 2XEX(I)-24DC + PT 2XEX(I)-BE  
2838225 + 2839279  
Page 132

### Protection of CANopen®/DeviceNet™

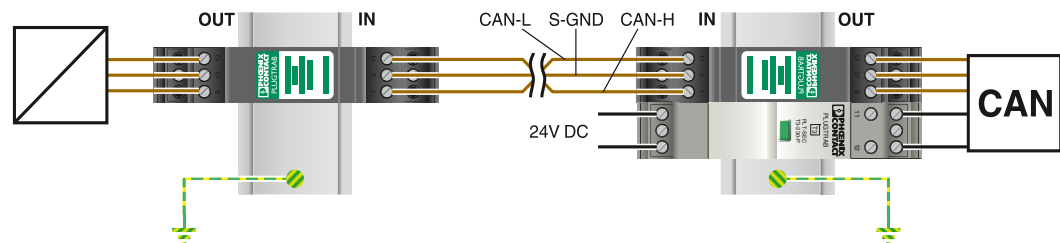
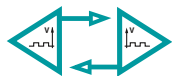

PT 3-HF-12DC-ST + PT 1X2-BE  
2858043 + 2856113  
Page 145

PLT-SEC-T3-24-FM  
2905223  
Page 71

PT 3-HF-12DC-ST + PT 1X2-BE  
2858043 + 2856113  
Page 145

### Protection of an RS-485 interface

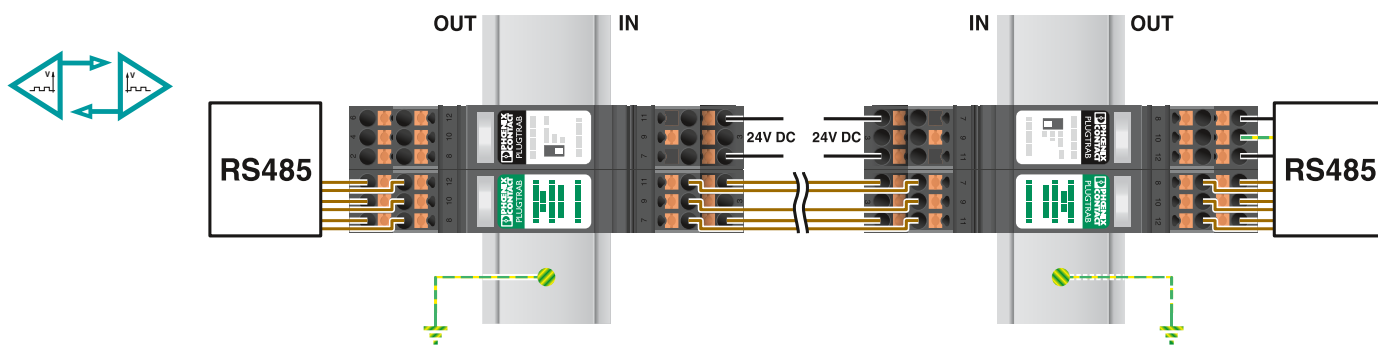

PT-IQ-PTB-PT + PT-IQ-5-HF+F-12DC-PT

2801296 + 2801295

Page 147

Optional

PT 5-HF-12DC-ST + PT 2X2+F-BE

2838775 + 2839224

Page 147

### Protection of an Ethernet interface (including PoE)

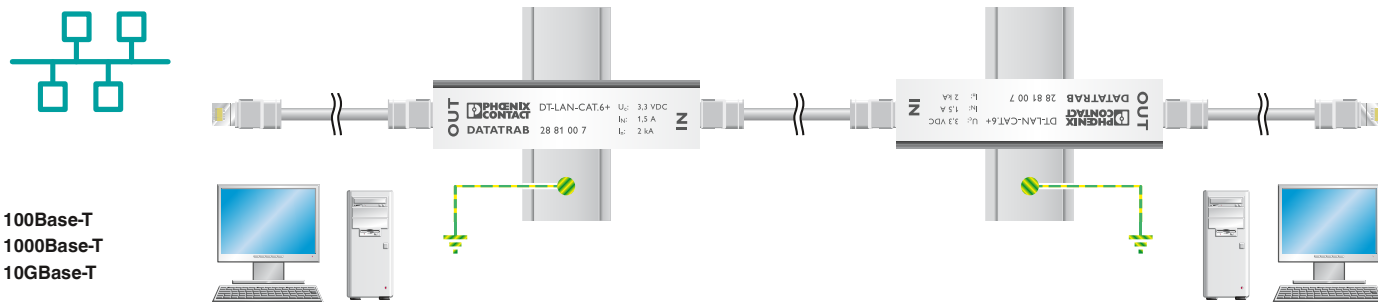

- 100Base-T
- 1000Base-T
- 10GBase-T

DT-LAN-CAT.6+

2881007

Page 142

### Protection of a DSL interface

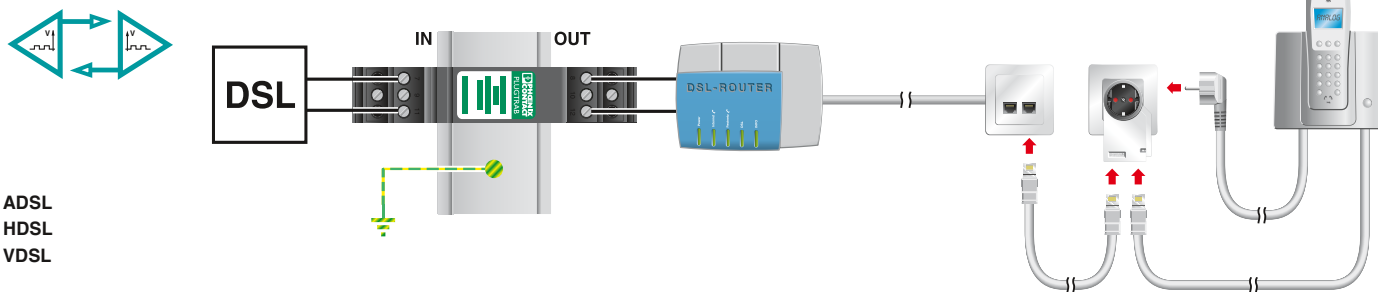

- ADSL
- HDSL
- VDSL

PT 2-TELE

2882828

Page 164

MNT-TAE D/WH

2882394

Page 74

# Surge protection and interference suppression filters

## Surge protection for information technology and telecommunications

### Ethernet/PROFINET networks with twisted pair cabling

#### DT-LAN-CAT.6+

- Suitable for category 6 high-speed data networks
- Secure data transmission up to 10 Gbps
- Protective adapter for eight signal paths via RJ45 connector
- Can be installed in a control cabinet by removing a ground connection adapter

#### D-LAN-CAT.5-FP

- Suitable for category 5 data networks
- Secure data transmission up to 1 Gbps
- Protective adapter for eight signal paths via RJ45 connector

#### D-LAN-19"

- 19" rack for installation in storey distributors
- Up to 24 ports with RJ45 connection
- Secure data transmission up to 1 Gbps
- Protection of all eight signal wires of the data cable
- Indirect grounding via a gas-filled surge arrester in the housing
- Direct grounding via a connection on the housing



For LAN interfaces (Class E<sub>A</sub>/CAT 6) including PoE and ISDN S<sub>0</sub> protection

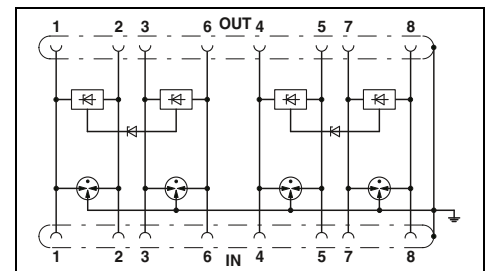

Electrical data	
IEC test classification/EN type	B2 / C1 / C2 / C3 / D1
Maximum continuous operating voltage U <sub>C</sub>	≤ 3.3V DC
Rated current	≤ 1.5 A (25 °C)
Nominal discharge current I <sub>n</sub> (8/20) μs	100 A / 2 kA (per signal pair)
Total discharge current I <sub>total</sub> (8/20) μs	10 kA
Protection level U <sub>p</sub>	Core-Core / Core-Ground ≤ 9 V (B2 - 1 kV/25 A) / ≤ 900 V (B2 - 4 kV/100 A)
Output voltage limitation at 1 kV/μs	Core-Core / Core-Ground ≤ 9 V / ≤ 700 V
Input attenuation aE (typical)	Core-Core / Core-Ground ≤ 1 dB (up to 100 MHz/direct measuring)
Cut-off frequency f <sub>g</sub> (3 dB)	> 500 MHz
In a 100 Ω system	Symmetrical
General data	
Dimensions W/H/D	25 mm / 102 mm / 63.5 mm
Temperature range	-40 °C ... 70 °C
Connection method	RJ45
Test standards	IEC 61643-21 / EN 50173-1 / ISO/IEC 11801-Am.1

#### Technical data

Ordering data		
Type	Order No.	Pcs./Pkt.
DT-LAN-CAT.6+	2881007	1

Description
<b>DATATRAB adapter</b> , protective adapter to be inserted into the data line
<b>DATATRAB</b> , for use in Ethernet, token ring, FDDI/CDDI in acc. with Cat.D/CAT5 EN 50173 (1000Base-T)
24 ports
20 ports
16 ports
12 ports
8 ports
4 ports
<b>Surge protection PCB</b> as replacement or for retrofitting in D-LAN-19"... products, incl. RJ45 sockets
4 ports



**For LAN interfaces (Class D/CAT 5) including PoE and ISDN S<sub>0</sub> protection**



**For data interfaces, with RJ45 connection Class D/CAT5e**

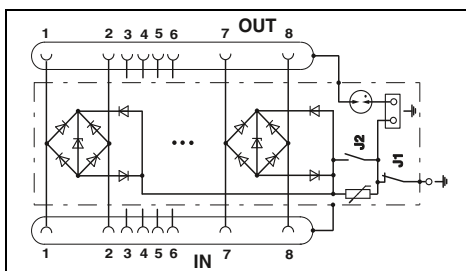
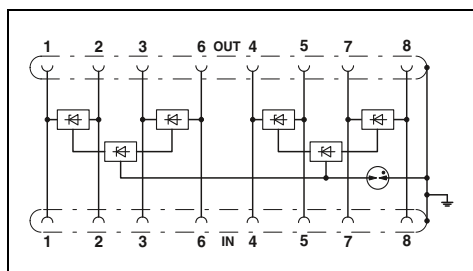

### Technical data

B2 / C1  
± 5 V DC  
-  
350 A / 350 A  
-  
≤ 35 V (C1 - 700 V/350 A) / ≤ 700 V (C1 - 700 V/350 A)  
≤ 25 V / ≤ 750 V  
≤ 1 dB (100 MHz/100 Ω)  
> 100 MHz

28 mm / 110 mm / 60 mm  
-40 °C ... 85 °C  
RJ45  
IEC 61643-21/A1 / GB/T 18802.21 / EN 61643-21/A1

### Technical data

C1 / C2 / C3 / B3  
6 V DC  
1.5 A (25 °C)  
350 A / 350 A  
10 kA  
≤ 50 V (C1 - 500 V / 250 A) / ≤ 40 V (C1 - 500 V / 250 A (J2 ON))  
≤ 20 V / ≤ 30 V (J2 plugged)  
typ. 1 dB (≤ 100 MHz)  
> 100 MHz

483 mm / 44 mm / 160 mm  
-40 °C ... 80 °C  
RJ45  
IEC 61643-21

### Ordering data

Type	Order No.	Pcs./Pkt.
D-LAN-CAT.5-FP	2800723	1

### Ordering data

Type	Order No.	Pcs./Pkt.
D-LAN-19"-24	2838791	1
D-LAN-19"-20	2880134	1
D-LAN-19"-16	2880147	1
D-LAN-19"-12	2880150	1
D-LAN-19"-8	2880163	1
D-LAN-19"-4	2880176	1
D-LAN-19"-D-P	2880192	1

# Surge protection and interference suppression filters

## Surge protection for information technology and telecommunications

### V.24/RS-232 interfaces

#### DT-UFB-V24/S

- Connection: D-SUB 9
- For data and handshake cables

#### Pin assignment DT-UFB-V24/S-9-SB

- 1,2,3,4,6,7,8,9 Data lines
- 5 Signal ground (Ground)

#### PLUGTRAB PT 3-HF-12DC

- Connection: screw terminal blocks
- For high transmission speeds
- High discharge capacity
- Plugs can be checked with CHECKMASTER

#### Pin assignment PT 3-HF-12DC:

- 7,11 Data lines
- 9 Signal ground (Ground)
- 3  $\perp$
- \* **Note:**PT .x.+F-BE connections 9/10 (GND) are linked to the mounting foot via a gas-filled surge arrester.

#### PLUGTRAB PT-IQ 3-HF-12DC

- Connection: Push-in or screw connection technology
- For high transmission speeds
- High discharge capacity
- Multi-stage, floating remote signaling
- Group message via supply and remote signaling module

#### Pin assignment PT-IQ 3-HF-12DC

- 7,11 Data line pair 2 R(A)/R(B)
- 9 Signal ground (Ground)
- 3  $\perp$



Protective adapter with 9-pos. D-SUB

Total width 25 mm

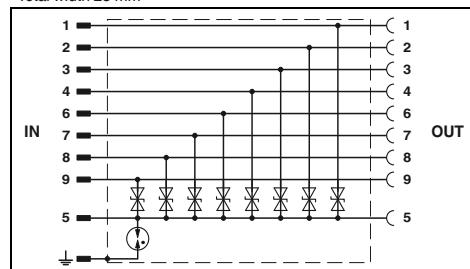

#### Technical data

Electrical data		
IEC test classification/EN type		B2 / C1 / C2 / C3
Maximum continuous operating voltage $U_c$		15 V DC / 10 V AC
Rated current		$\leq 1$ A (25 °C)
Nominal discharge current $I_n$ (8/20) $\mu$ s		$\leq 250$ A / $\leq 250$ A
Total discharge current $I_{total}$ (8/20) $\mu$ s	Core-Ground / Core-GND	5 kA
Protection level $U_p$	Core-Core / Core-Ground	$\leq 55$ V (C1 - 250 A) / $\leq 450$ V (C1 - 250 A)
Cut-off frequency fg (3 dB)		typ. 2.5 MHz / typ. 1.3 MHz
In a 100 $\Omega$ system	Symmetrical / Asymmetrical	typ. 2.5 MHz / typ. 1.3 MHz
In a 150 $\Omega$ system	Symmetrical / Asymmetrical	typ. 2.5 MHz / -
In a 100 $\Omega$ system	Symmetrical / Asymmetrical	typ. 2.5 MHz / -
In a 150 $\Omega$ system	Symmetrical / Asymmetrical	typ. 2.5 MHz / -
General data		
Dimensions W/H/D		25 mm / 108 mm / 63 mm
Temperature range		-40 °C ... 85 °C
Connection method		D-SUB-9
Test standards		DIN EN 61643-21 / IEC 61643-21

#### Ordering data

Type	Order No.	Pcs./Pkt.
DT-UFB-V24/S-9-SB	2803069	1

#### Accessories

Description
<b>DATATRAB adapter</b> , protective adapter for inserting into the data line for protecting the V.24 / RS-232 interface with D-SUB-9 connector
<b>PLUGTRAB plug</b> , with protective circuit for plugging into the PT base element
<b>PLUGTRAB base element</b> , for mounting on NS 35 with a gas-filled surge arrester between the 3/4 ( $\perp$ ) and the 9/10 connections
<b>PLUGTRAB</b> , consisting of a plug, base element, and DIN rail bus Screw connection technology Push-in connection technology
<b>PLUGTRAB</b> , supply and remote signaling module Screw connection technology Push-in connection technology
<b>Marking material</b>



**Pluggable arrester with screw connection, for three conductors, with common reference potential**



**3-wire protection for fieldbus and serial interface, connection 9/10 grounded via gas-filled surge arrester**

Total width 17.7 mm

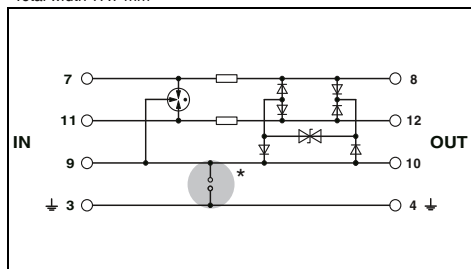

### Technical data

C1 / C2 / C3 / D1  
14 V DC / 9.8 V AC  
450 mA (45°C)

10 kA / 10 kA  
20 kA

≤ 50 V (C3 - 25 A) / ≤ 50 V (C3 - 25 A)

typ. 60 MHz / -  
- / -  
typ. 60 MHz / -  
- / -

17.7 mm / 90 mm / 65.5 mm  
-40 °C ... 85 °C  
Screw connection (in connection with the base element)

EN 61643-21/A1 / IEC 61643-21/A1

### Ordering data

Type	Order No.	Pcs./Pkt.
PT 3-HF-12DC-ST	2858043	10
PT 1X2+F-BE	2856126	10

### Accessories

--	--	--

Total width 17.7 mm

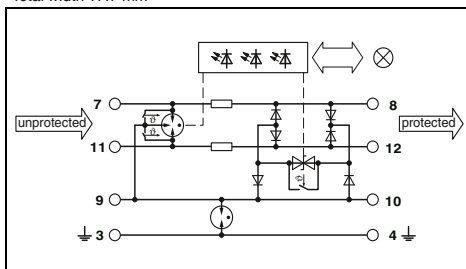

### Technical data

C1 / C2 / C3 / D1  
15 V DC / 10 V AC  
600 mA (40°C)

10 kA / -  
20 kA

≤ 40 V (C3 - 25 A) / ≤ 900 V (C3 - 25 A)

- / -  
typ. 60 MHz / typ. 60 MHz  
- / -  
typ. 60 MHz / -

17.7 mm / 91.1 mm / 77.5 mm  
-40 °C ... 70 °C  
Screw connection

IEC 61643-21 / EN 61643-21 / EN 61000-6-2 /

### Ordering data

Type	Order No.	Pcs./Pkt.
PT-IQ-3-HF+F-12DC-UT	2800995	1
PT-IQ-3-HF+F-12DC-PT	2801289	1

### Accessories

PT-IQ-PTB-UT	2800768	1
PT-IQ-PTB-PT	2801296	1

ZBF ..., see page 197

# Surge protection and interference suppression filters

## Surge protection for information technology and telecommunications

### RS-485 interfaces

#### PLUGTRAB PT-IQ 5-HF

- Connection: Push-in or screw connection technology
- For high transmission speeds
- High discharge capacity
- Multi-stage, floating remote signaling
- Group message via supply and remote signaling module

#### Pin assignment PT-IQ-5-HF-12DC

- 1,5 Data line pair 1T(A)/T(B)
- 7,11 Data line pair 2 R(A)/R(B)
- 9 Signal ground (Ground)
- 3  $\perp$

#### PLUGTRAB PT 5-HF

- High transmission speed
- Fast response time
- High discharge capacity
- Plugs can be checked with CHECKMASTER

#### Pin assignment PT 5-HF...

- 1,5 Data line pair 1T(A)/T(B)
- 7,11 Data line pair 2 R(A)/R(B)
- 9 Signal ground (Ground)
- 3  $\perp$

#### \* Note:

Various grounding options for the base elements:

**PT .x.-BE** connections 9/10 (GND) directly connected to the mounting foot.

**PT .x.+F-BE** connections 9/10 (GND) connected to the mounting foot via a gas-filled surge arrester.

#### DATATRAB DT-UFB-485

- Adapter type
- 9-pos. D-SUB connection
- DIN rail mounting possible by removing the cap

#### Pin assignment DT-UFB-485:

- 3,8 Data line pair 1 T(A)/T(B)
- 4,9 Data line pair 2 R(A)/R(B)
- 2,7 Signal ground (Ground)
- $\perp$   $\perp$

<b>Notes:</b>
Attenuation characteristics at phoenixcontact.net/products



5-wire with common reference potential, 9/10 connection grounded directly

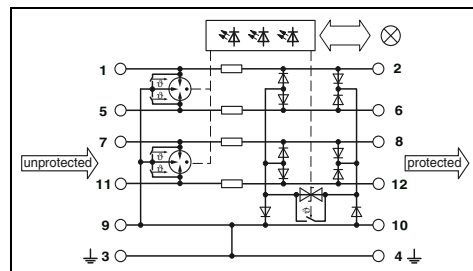

#### Technical data

Electrical data		... 5DC	... 12DC
IEC test classification/EN type		C1 / C2 / C3 / D1	C1 / C2 / C3 / D1
Maximum continuous operating voltage $U_c$		6 V DC / 4 V AC	15 V DC / 10 V AC
Rated current		600 mA (40°C)	600 mA (40°C)
Nominal discharge current $I_n$ (8/20) $\mu$ s	Core-Core / Core-Ground	10 kA / 10 kA	10 kA / 10 kA
Total discharge current $I_{total}$ (8/20) $\mu$ s		20 kA	20 kA
Protection level $U_p$	Core-Core / Core-Ground	$\leq 30$ V (C3 - 25 A) / $\leq 30$ V (C3 - 25 A)	$\leq 40$ V (C3 - 25 A) / $\leq 40$ V (C3 - 25 A)
Cut-off frequency fg (3 dB)		-	-
In a 100 $\Omega$ system	Symmetrical	-	-
In a 150 $\Omega$ system	Symmetrical	-	-
General data		typ. 60 MHz	typ. 60 MHz
Dimensions W/H/D		17.7 mm / 91 mm / 77.5 mm	17.7 mm / 91 mm / 77.5 mm
PT-IQ...UT dimensions W/H/D		17.7 mm / 91 mm / 77.5 mm	17.7 mm / 109.3 mm / 77.5 mm
PT-IQ...PT dimensions W/H/D			17.7 mm / 109.3 mm / 77.5 mm
Temperature range		-40 °C ... 70 °C	-40 °C ... 70 °C
Connection method		Screw connection	Push-in connection
Test standards		IEC 61643-21 / EN 61643-21 / EN 61000-6-2 /	

#### Ordering data

Description	Nominal voltage $U_N$	Type	Order No.	Pcs./Pkt.
<b>MCR-PLUGTRAB</b> , consisting of a plug, base element, and DIN rail bus, with screw connection technology	5 V DC 12 V DC	<b>PT-IQ-5-HF-5DC-UT</b> <b>PT-IQ-5-HF-12DC-UT</b>	<b>2800797</b> <b>2800799</b>	1 1
<b>MCR-PLUGTRAB</b> , consisting of a plug, base element, and DIN rail bus, with Push-in connection technology	5 V DC 12 V DC	<b>PT-IQ-5-HF-5DC-PT</b> <b>PT-IQ-5-HF-12DC-PT</b>	<b>2801291</b> <b>2801293</b>	1 1
<b>PLUGTRAB plug</b> , with protective circuit for plugging into the PT base element				
<b>PLUGTRAB base element</b> , for mounting on NS 35				
	Bridge between 3/4 ( $\perp$ ) and 9/10 Gas-filled surge arrester between 3/4 ( $\perp$ ) and 9/10			
<b>DATATRAB adapter</b> , protective adapter for inserting into the data line				

#### Accessories

<b>PLUGTRAB</b> , supply and remote signaling module				
Screw connection technology				
Push-in connection technology				
<b>PT-IQ-PTB-UT</b>		<b>2800768</b>	1	
<b>PT-IQ-PTB-PT</b>		<b>2801296</b>	1	

# Surge protection and interference suppression filters

## Surge protection for information technology and telecommunications



5-wire with common reference potential, 9/10 connection grounded via gas-filled surge arrester



Pluggable arrester with screw connection, for five conductors, with common reference potential



Protective adapter with 9-pos. D-SUB

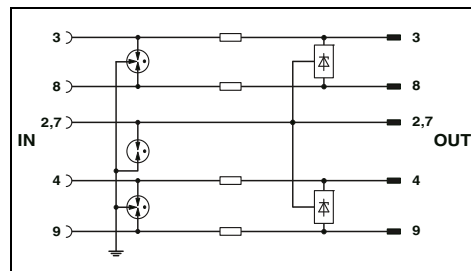
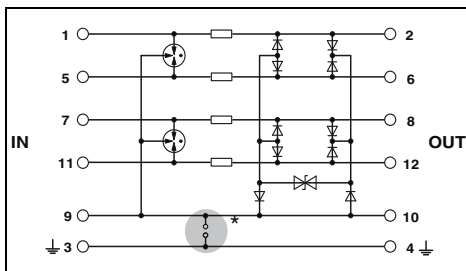
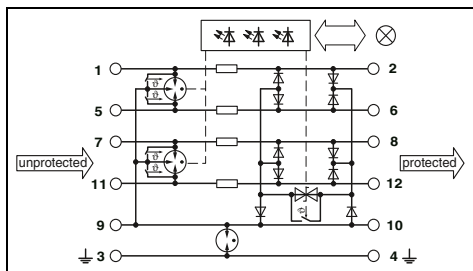

Technical data	
... 5DC	... 12DC
C1 / C2 / C3 / D1	C1 / C2 / C3 / D1
6 V DC / 4 V AC	15 V DC / 10 V AC
600 mA (40°C)	600 mA (40°C)
10 kA / 10 kA	10 kA / 10 kA
20 kA	20 kA
≤ 30 V (C3 - 25 A) / ≤ 900 V (C3 - 25 A)	≤ 40 V (C3 - 25 A) / ≤ 900 V (C3 - 25 A)
-	-
typ. 60 MHz	typ. 60 MHz
17.7 mm / 91 mm / 77.5 mm 17.7 mm / 91 mm / 77.5 mm 17.7 mm / 109.3 mm / 77.5 mm -40 °C ... 70 °C	
Screw connection	Push-in connection
IEC 61643-21 / EN 61643-21 / EN 61000-6-2 /	

Technical data	
... 5DC	... 12DC
C1 / C2 / C3 / D1	C1 / C2 / C3 / D1
5.2 V DC / 3.6 V AC	14 V DC / 9.8 V AC
450 mA (45°C)	450 mA (45°C)
10 kA / 10 kA	10 kA / 10 kA
20 kA	20 kA
≤ 45 V (C3 - 25 A) / ≤ 45 V (C3 - 25 A)	≤ 50 V (C3 - 25 A) / ≤ 50 V (C3 - 25 A)
typ. 60 MHz	typ. 60 MHz
-	-
17.7 mm / 90 mm / 65.5 mm - - -40 °C ... 85 °C	
Screw connection (in connection with the base element)	Screw connection (in connection with the base element)
EN 61643-21/A1 / IEC 61643-21/A1	

Technical data	
B2 / C1 / C2 / C3 / D1	
12 V DC	
≤ 380 mA (25 °C)	
≤ 5 kA / ≤ 5 kA	
10 kA	
≤ 30 V (C1 - 500 A) / ≤ 700 V (C1 - 500 A)	
typ. 50 MHz	
-	
25 mm / 108 mm / 63 mm - - -40 °C ... 85 °C	
D-SUB-9	
DIN EN 61643-21	

Ordering data		
Type	Order No.	Pcs./Pkt.
PT-IQ-5-HF+F-5DC-UT	2800798	1
PT-IQ-5-HF+F-12DC-UT	2800801	1
PT-IQ-5-HF+F-5DC-PT	2801292	1
PT-IQ-5-HF+F-12DC-PT	2801295	1

Ordering data		
Type	Order No.	Pcs./Pkt.
PT 5-HF- 5 DC-ST	2838762	10
PT 5-HF-12 DC-ST	2838775	10
PT 2X2-BE	2839208	10
PT 2X2+F-BE	2839224	10

Ordering data		
Type	Order No.	Pcs./Pkt.
DT-UFB-485/BS	2920612	1

Accessories		
Type	Order No.	Pcs./Pkt.
PT-IQ-PTB-UT	2800768	1
PT-IQ-PTB-PT	2801296	1

Accessories		
Type	Order No.	Pcs./Pkt.

Accessories		
Type	Order No.	Pcs./Pkt.

# Surge protection and interference suppression filters

## Surge protection for information technology and telecommunications

### V.11/RS-422 interfaces

#### PLUGTRAB PT 5-HF-12DC

- For high data transmission rates
- Plugs can be checked with CHECKMASTER
- 9/10 connections (GND) are connected to the mounting foot via a gas-filled surge arrester

#### PLUGTRAB PT-IQ-5-HF-12DC

- Connection: Push-in or screw connection technology
- For high transmission speeds
- Multi-stage, floating remote signaling
- Group message via supply and remote signaling module



Pluggable arrester with screw connection, for five conductors, with common reference potential



5-wire with common reference potential, 9/10 connection grounded via gas-filled surge arrester

**Notes:**  
Attenuation characteristics at phoenixcontact.net/products

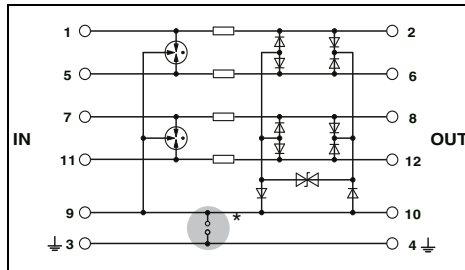

#### Technical data

Electrical data	
IEC test classification/EN type	C1 / C2 / C3 / D1
Maximum continuous operating voltage $U_C$	14 V DC / 9.8 V AC
Rated current	450 mA (45°C)
Nominal discharge current $I_n$ (8/20) $\mu$ s	Core-Core / Core-Ground 10 kA / 20 kA (in total)
Total discharge current $I_{total}$ (8/20) $\mu$ s	20 kA
Protection level $U_p$	Core-Core / Core-Ground $\leq 50$ V (C3 - 25 A) / $\leq 50$ V (C3 - 25 A)
Cut-off frequency $f_g$ (3 dB)	
In a 100 $\Omega$ system	Symmetrical typ. 60 MHz
In a 150 $\Omega$ system	Symmetrical / Asymmetrical - / -
General data	
Dimensions W/H/D	17.7 mm / 90 mm / 65.5 mm
Temperature range	-40 °C ... 85 °C
Test standards	EN 61643-21 / IEC 61643-21

Electrical data	
IEC test classification/EN type	C1 / C2 / C3 / D1
Maximum continuous operating voltage $U_C$	15 V DC / 10 V AC
Rated current	600 mA (40°C)
Nominal discharge current $I_n$ (8/20) $\mu$ s	10 kA / 10 kA
Total discharge current $I_{total}$ (8/20) $\mu$ s	20 kA
Protection level $U_p$	$\leq 40$ V (C3 - 25 A) / $\leq 900$ V (C3 - 25 A)
Cut-off frequency $f_g$ (3 dB)	
In a 100 $\Omega$ system	-
In a 150 $\Omega$ system	typ. 60 MHz / typ. 60 MHz
General data	
Dimensions W/H/D	17.7 mm / 91 mm / 77.5 mm
Temperature range	-40 °C ... 70 °C
Test standards	IEC 61643-21 / EN 61643-21 / EN 61000-6-2 /

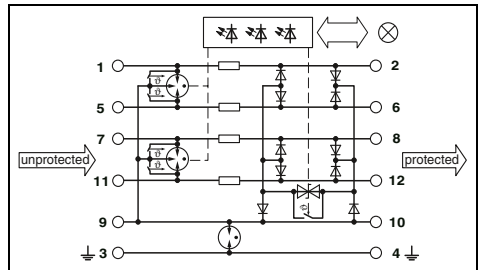

#### Technical data

Description	Nominal voltage $U_N$
<b>PLUGTRAB plug</b> , with protective circuit for inserting in PT base element	12 V DC
<b>PLUGTRAB base element</b> , for mounting on NS 35	
Gas-filled surge arrester between 3/4 ( $\downarrow$ ) and 9/10	
<b>PLUGTRAB</b> , consisting of a plug, base element, and DIN rail bus	
Screw connection technology	

#### Ordering data

Type	Order No.	Pcs./Pkt.
PT 5-HF-12 DC-ST	2838775	10
PT 2X2+F-BE	2839224	10

#### Ordering data

Type	Order No.	Pcs./Pkt.
PT-IQ-5-HF+F-12DC-UT	2800801	1
PT-IQ-5-HF+F-12DC-PT	2801295	1

<b>PLUGTRAB</b> , supply and remote signaling module
Screw connection technology
Push-in connection technology

#### Accessories

ZBF ..., see page 197
-----------------------

#### Accessories

PT-IQ-PTB-UT	2800768	1
PT-IQ-PTB-PT	2801296	1

**Marking material**

### TTY interfaces

#### PLUGTRAB PT 2X2-24DC

- Plugs can be checked with CHECKMASTER
- 9/10 connections (GND) are directly connected to the mounting foot

#### PLUGTRAB PT-IQ-2X2-24DC

- Connection: Push-in or screw connection technology
- Multi-stage, floating remote signaling
- Group message via supply and remote signaling module



Two double wires (loops), floating, for 20 mA current loops



2 double wires (loops), floating, connection 9/10 grounded directly, e.g., for 4 ... 20 mA current loop

#### Notes:

Attenuation characteristics at phoenixcontact.net/products

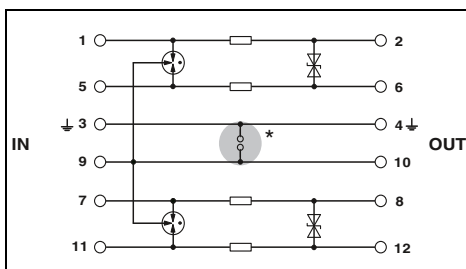

#### Technical data

Electrical data	
IEC test classification/EN type	C1 / C2 / C3 / D1
Maximum continuous operating voltage $U_c$	28 V DC / 20 V AC
Rated current	450 mA (45 °C)
Nominal discharge current $I_n$ (8/20) $\mu$ s	Core-Core / Core-Ground 10 kA / 10 kA
Total discharge current $I_{total}$ (8/20) $\mu$ s	20 kA
Protection level $U_p$	Core-Core / Core-Ground $\leq 50$ V (C3 - 25 A) / $\leq 450$ V (C1 - 1 kV / 500 A with PT 2X2-BE)
Cut-off frequency $f_g$ (3 dB)	
In a 50 $\Omega$ system	Symmetrical typ. 4.5 MHz
General data	
Dimensions W/H/D	17.7 mm / 90 mm / 65.5 mm
Temperature range	-40 °C ... 85 °C
Test standards	IEC 61643-21 / EN 61643-21

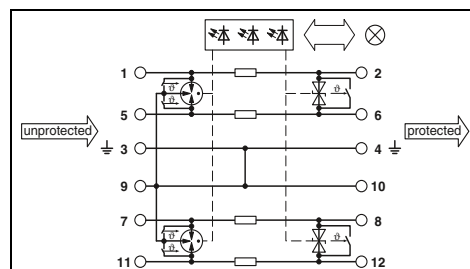

#### Technical data

Electrical data	
IEC test classification/EN type	C1 / C2 / C3 / D1
Maximum continuous operating voltage $U_c$	30 V DC / 21 V AC
Rated current	700 mA (50 °C)
Nominal discharge current $I_n$ (8/20) $\mu$ s	Core-Core / Core-Ground 10 kA / 10 kA
Total discharge current $I_{total}$ (8/20) $\mu$ s	20 kA
Protection level $U_p$	Core-Core / Core-Ground $\leq 55$ V (C3 - 25 A) / $\leq 700$ V (C3 - 25 A)
Cut-off frequency $f_g$ (3 dB)	
In a 50 $\Omega$ system	-
General data	
Dimensions W/H/D	17.7 mm / 91 mm / 77.5 mm
Temperature range	-40 °C ... 70 °C
Test standards	IEC 61643-21 / EN 61643-21 / EN 61000-6-3 /

Description	Nominal voltage $U_N$
<b>PLUGTRAB plug</b> , with protective circuit for inserting in PT base element	24 V DC
<b>PLUGTRAB base element</b> , for mounting on NS 35	
Bridge between 3/4 ( $\downarrow$ ) and 9/10	
<b>PLUGTRAB</b> , consisting of a plug, base element, and DIN rail bus	
Screw connection technology	
Push-in connection technology	

<b>Shield fast connection</b>	
For $\varnothing$ 3-6 mm	
For $\varnothing$ 5-10 mm	
<b>PLUGTRAB</b> , supply and remote signaling module	
Screw connection technology	
Push-in connection technology	

Ordering data		
Type	Order No.	Pcs./Pkt.
PT 2X2-24DC-ST	2838228	10
PT 2X2-BE	2839208	10

Accessories		
Type	Order No.	Pcs./Pkt.
SSA 3-6	2839295	10
SSA 5-10	2839512	10

Ordering data		
Type	Order No.	Pcs./Pkt.
PT-IQ-2X2-24DC-UT	2800980	1

Accessories		
Type	Order No.	Pcs./Pkt.
PT-IQ-PTB-UT	2800768	1
PT-IQ-PTB-PT	2801296	1

# Surge protection and interference suppression filters

## Surge protection for information technology and telecommunications

### PROFIBUS DP/PA fieldbus system TERMITRAB complete

- One-piece or pluggable surge protection
- Overall width of just 6.2 mm
- With Push-in or screw connection technology
- Integrated mechanical status indicator
- Impedance-neutral insertion and removal
- Coded connector versions
- With knife disconnection
- Optional remote signaling module monitors up to 40 items, without additional wiring
- Plugs can be tested with CHECKMASTER 2

SIL  
evaluated  
IEC 61508

D  
H  
W



**3-conductor with common reference potential,  
3/6 connection grounded directly, one-piece**

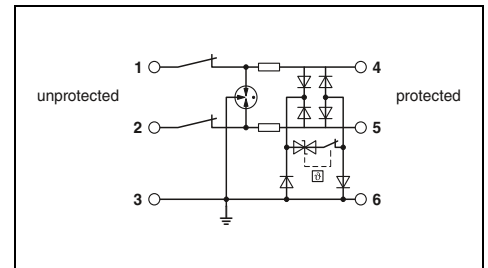

#### Technical data

<b>Electrical data</b>	
IEC test classification/EN type	... 12DC
Maximum continuous operating voltage $U_c$	C1 / C2 / C3 / D1
Rated current	15 V DC
Pulse discharge current $I_{mp}$ (10/350) $\mu$ s	600 mA (40°C)
Nominal discharge current $I_n$ (8/20) $\mu$ s	0.5 kA
Total discharge current $I_{total}$ (8/20) $\mu$ s	Core-Core / Core-Ground
Protection level $U_p$	5 kA / 5 kA
	10 kA
Cut-off frequency $f_g$ (3 dB)	Core-Core / Core-Ground
	$\leq 25$ V (C3 - 25 A) /
	$\leq 25$ V (C3 - 25 A)
Resistance per path	Symmetrical in the 150 $\Omega$ system
<b>General data</b>	
Dimensions W/H/D	typ. 60 MHz
Connection data solid/stranded/AWG	1.65 $\Omega$
Temperature range	6.2 mm / 105.8 mm / 83.5 mm
Test standards	0.2...4 mm <sup>2</sup> / 0.2...2.5 mm <sup>2</sup> / 24 ... 12
	-40 °C ... 85 °C
	IEC 61643-21 / EN 61643-21

Ordering data		
Type	Order No.	Pcs./Pkt.
TERMITRAB complete, with screw connection technology		
	12 V DC	
	24 V DC	
TERMITRAB complete, with Push-in connection technology		
	12 V DC	
	24 V DC	
TTC-6-3-HF-M-12DC-UT-I	2906721	1
TTC-6-3-HF-M-12DC-PT-I	2906732	1

SIL  
evaluated  
IEC 61508



new

SIL  
evaluated  
IEC 61508



new

SIL  
evaluated  
IEC 61508



new

3-conductor with common reference potential,  
3/6 connection grounded via gas-filled surge  
arrestor, one-piece

3-conductor with common reference potential,  
3/6 connection grounded directly, pluggable

3-conductor with common reference potential,  
3/6 connection grounded via gas-filled surge  
arrestor, pluggable

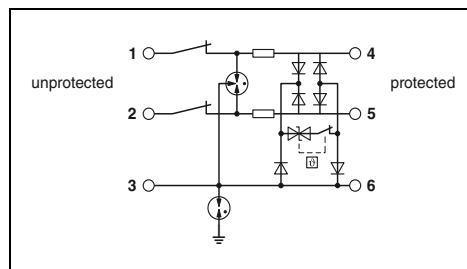
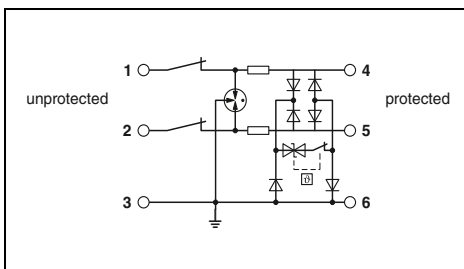
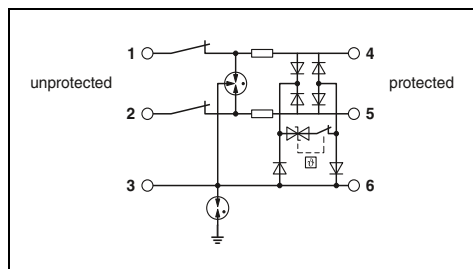

Technical data	
... 12DC	... 24DC
C1 / C2 / C3 / D1	C1 / C2 / C3 / D1
15 V DC	30 V DC
600 mA (40°C)	600 mA (40°C)
0.5 kA	0.5 kA
5 kA / 5 kA	5 kA / 5 kA
10 kA	10 kA
≤ 25 V (C3 - 25 A) / ≤ 1.1 kV (C3 - 25 A)	≤ 45 V (C3 - 25 A) / ≤ 110 V (C3 - 25 A)
typ. 60 MHz	typ. 60 MHz
1.65 Ω	1.65 Ω
6.2 mm / 105.8 mm / 83.5 mm	
0.2...4 mm <sup>2</sup> / 0.2...2.5 mm <sup>2</sup> / 24 ... 12	
-40 °C ... 85 °C	
IEC 61643-21 / EN 61643-21	

Technical data	
... 12DC	... 24DC
C1 / C2 / C3 / D1	C1 / C2 / C3 / D1
15 V DC	30 V DC
600 mA (40°C)	600 mA (40°C)
0.5 kA	0.5 kA
5 kA / 5 kA	5 kA / 5 kA
10 kA	10 kA
≤ 25 V (C3 - 25 A) / ≤ 25 V (C3 - 25 A)	≤ 45 V (C3 - 25 A) / ≤ 110 V (C3 - 25 A)
typ. 60 MHz	typ. 60 MHz
1.65 Ω	1.65 Ω
6.2 mm / 105.8 mm / 100 mm	
0.2...4 mm <sup>2</sup> / 0.2...2.5 mm <sup>2</sup> / 24 ... 12	
-40 °C ... 85 °C	
IEC 61643-21 / EN 61643-21	

Technical data	
... 12DC	... 24DC
C1 / C2 / C3 / D1	C1 / C2 / C3 / D1
15 V DC	30 V DC
600 mA (40°C)	600 mA (40°C)
0.5 kA	0.5 kA
5 kA / 5 kA	5 kA / 5 kA
10 kA	10 kA
≤ 25 V (C3 - 25 A) / ≤ 1.1 kV (C3 - 25 A)	≤ 45 V (C3 - 25 A) / ≤ 110 V (C3 - 25 A)
typ. 60 MHz	typ. 60 MHz
1.65 Ω	1.65 Ω
6.2 mm / 105.8 mm / 100 mm	
0.2...4 mm <sup>2</sup> / 0.2...2.5 mm <sup>2</sup> / 24 ... 12	
-40 °C ... 85 °C	
IEC 61643-21 / EN 61643-21	

Ordering data		
Type	Order No.	Pcs./Pkt.
TTC-6-3-HF-F-M-12DC-UT-I	2906769	1
TTC-6-3-HF-F-M-24DC-UT-I	2906770	1
TTC-6-3-HF-F-M-12DC-PT-I	2906778	1
TTC-6-3-HF-F-M-24DC-PT-I	2906779	1

Ordering data		
Type	Order No.	Pcs./Pkt.
TTC-6P-3-HF-M-12DC-UT-I	2906744	1
TTC-6P-3-HF-M-12DC-PT-I	2906756	1

Ordering data		
Type	Order No.	Pcs./Pkt.
TTC-6P-3-HF-F-M-12DC-UT-I	2906786	1
TTC-6P-3-HF-F-M-24DC-UT-I	2906787	1
TTC-6P-3-HF-F-M-12DC-PT-I	2906796	1
TTC-6P-3-HF-F-M-24DC-PT-I	2906797	1

# Surge protection and interference suppression filters

## Surge protection for information technology and telecommunications

### PROFIBUS DP fieldbus system PLUGTRAB PT-IQ

- Multi-stage status monitoring
- Group message via supply and remote signaling module
- Multi-stage, floating remote signaling
- System supplied via DIN rail bus
- Up to 28 protection modules per supply module
- Maximum ease of maintenance thanks to the two-piece design
- Plugs are coded
- Impedance-neutral disconnection of plug for maintenance purposes
- PT-IQ...-UT base element with screw connection technology
- PT-IQ...-PT base element with Push-in connection technology
- Base element remains an integral part of the installation
- Corresponding replacement plugs can be found on our website



Supply and remote signaling module

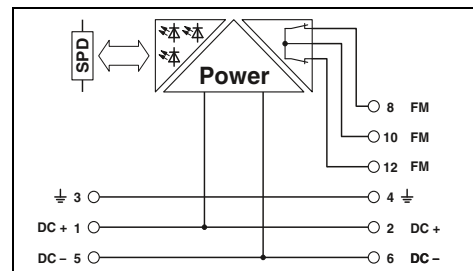

#### Technical data

Electrical data	
IEC test classification/EN type	-
Maximum continuous operating voltage $U_c$	-
Rated current	-
Pulse discharge current $I_{imp}$ (10/350) $\mu s$	-
Nominal discharge current $I_n$ (8/20) $\mu s$	-
	Core-Core / Core-Ground
Total discharge current $I_{total}$ (8/20) $\mu s$	- / -
Max. discharge current $I_{max}$ (8/20) $\mu s$	-
Protection level $U_p$	-
	Core-Core
	Core-Ground
Cut-off frequency $f_g$ (3 dB)	-
	Symmetrical in the 150 $\Omega$ system
	-
Resistance per path	-
General data	
PT-IQ...UT dimensions W/H/D	17.7 mm / 91.1 mm / 77.5 mm
PT-IQ...PT dimensions W/H/D	17.7 mm / 109.3 mm / 77.5 mm
Connection data solid/stranded/AWG	0.2...4 mm <sup>2</sup> / 0.2...2.5 mm <sup>2</sup> / 24 ... 12
Temperature range	-40 °C ... 70 °C
Test standards	EN 61000-6-2 / EN 61000-6-3 / EN 60950-1 / EN 60079-0 / EN 60079-11 / EN 60079-15
Remote indication contact	
Connection data solid/stranded/AWG	2x N/C contacts
Max. operating voltage	0.2...4 mm <sup>2</sup> / 0.2...2.5 mm <sup>2</sup> / 24 ... 14
Max. operating current	30 V AC (50/60 Hz, non-Ex) / 50 V DC (non-Ex) 1 A (up to 50°C, non-Ex)

#### Ordering data

Description	Voltage $U_N$	Type	Order No.	Pcs./Pkt.
<b>PLUGTRAB</b> , supply and remote signaling module				
Screw connection technology		<b>PT-IQ-PTB-UT</b>	<b>2800768</b>	1
Push-in connection technology		<b>PT-IQ-PTB-PT</b>	<b>2801296</b>	1
<b>MCR-PLUGTRAB</b> , with screw connection technology	5 V DC 12 V DC			
<b>MCR-PLUGTRAB</b> , with Push-in connection technology	5 V DC 12 V DC			

# Surge protection and interference suppression filters

## Surge protection for information technology and telecommunications



3-wire protection for fieldbus and serial interface, connection 9/10 grounded directly



5-wire with common reference potential, 9/10 connection grounded directly

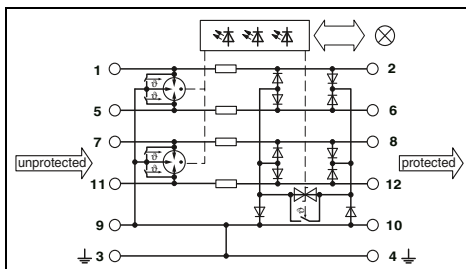
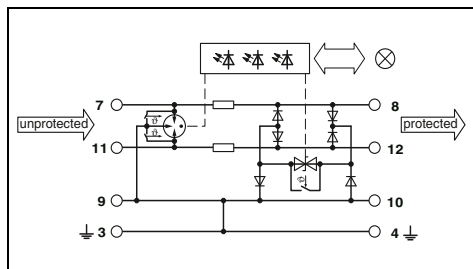

### Technical data

... 5DC	... 12DC
C1 / C2 / C3 / D1	C1 / C2 / C3 / D1
6 V DC / 4 V AC	15 V DC / 10 V AC
600 mA (40°C)	600 mA (40°C)
2.5 kA	2.5 kA

10 kA / 10 kA	10 kA / 10 kA
20 kA	20 kA
-	-

≤ 30 V (C3 - 25 A)	≤ 40 V (C3 - 25 A)
≤ 30 V (C3 - 25 A)	≤ 40 V (C3 - 25 A)

typ. 60 MHz	typ. 60 MHz
1.2 Ω	1.2 Ω

17.7 mm / 91.1 mm / 77.5 mm  
 17.7 mm / 109.3 mm / 77.5 mm  
 0.2...4 mm<sup>2</sup> / 0.2...2.5 mm<sup>2</sup> / 24 ... 12  
 -40 °C ... 70 °C  
 IEC 61643-21 / EN 61643-21 / EN 61000-6-2 /  
 EN 61000-6-3

Via TBUS  
 - mm<sup>2</sup> / - mm<sup>2</sup> / -

### Technical data

... 5DC	... 12DC
C1 / C2 / C3 / D1	C1 / C2 / C3 / D1
6 V DC / 4 V AC	15 V DC / 10 V AC
600 mA (40°C)	600 mA (40°C)
2.5 kA	2.5 kA

10 kA / 10 kA	10 kA / 10 kA
20 kA	20 kA
-	-

≤ 30 V (C3 - 25 A)	≤ 40 V (C3 - 25 A)
≤ 30 V (C3 - 25 A)	≤ 40 V (C3 - 25 A)

typ. 60 MHz	typ. 60 MHz
1.2 Ω	1.2 Ω

17.7 mm / 91 mm / 77.5 mm  
 17.7 mm / 109.3 mm / 77.5 mm  
 0.2...4 mm<sup>2</sup> / 0.2...2.5 mm<sup>2</sup> / 24 ... 12  
 -40 °C ... 70 °C  
 IEC 61643-21 / EN 61643-21 / EN 61000-6-2 /  
 EN 61000-6-3

Via TBUS  
 - mm<sup>2</sup> / - mm<sup>2</sup> / -

### Ordering data

Type	Order No.	Pcs./Pkt.
PT-IQ-3-PB-UT	2800785	1
PT-IQ-3-HF-12DC-UT	2800786	1
PT-IQ-3-PB-PT	2801286	1
PT-IQ-3-HF-12DC-PT	2801288	1

### Ordering data

Type	Order No.	Pcs./Pkt.
PT-IQ-5-HF-5DC-UT	2800797	1
PT-IQ-5-HF-12DC-UT	2800799	1
PT-IQ-5-HF-5DC-PT	2801291	1
PT-IQ-5-HF-12DC-PT	2801293	1

# Surge protection and interference suppression filters

## Surge protection for information technology and telecommunications

### PROFIBUS DP fieldbus system PLUGTRAB PT

**Notes:**  
Attenuation characteristics at phoenixcontact.net/products

#### PLUGTRAB PT 3-PB(HF)... / PT 5-HF...

- Protection for PROFIBUS (up to 12 Mbps), in three to five-conductor technology
- Cable shield connection with SSA... shield fast connection
- Maximum ease of maintenance thanks to the two-piece design
- Base element remains an integral part of the installation
- Impedance-neutral disconnection of plug for test and maintenance purposes

#### DATATRAB D-UFB-PB

- Direct use at the PROFIBUS interface
- Data transmission rate of up to 12 Mbps
- Integrated termination resistor



Pluggable arrester with screw connection, for three conductors, with common reference potential

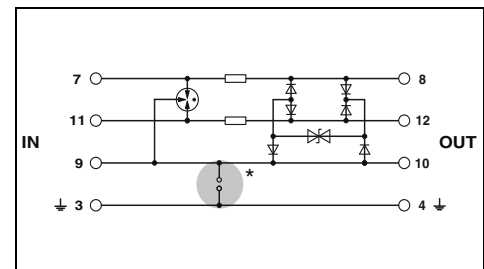

#### Technical data

Electrical data		C1 / C2 / C3 / D1	
IEC test classification/EN type		5.2 V DC / 3.6 V AC	
Maximum continuous operating voltage $U_c$		450 mA (45°C)	
Rated current			
Nominal discharge current $I_n$ (8/20) $\mu$ s	Core-Core / Core-Ground	10 kA / 10 kA	
Total discharge current $I_{total}$ (8/20) $\mu$ s		20 kA	
Protection level $U_p$	Core-Core / Core-Ground	$\leq 45$ V (C3 - 25 A) / $\leq 45$ V (C3 - 25 A)	
Output voltage limitation at 1 kV/ $\mu$ s	Core-Core / Core-Ground	$\leq 15$ V / $\leq 15$ V	
Cut-off frequency $f_g$ (3 dB)		typ. 60 MHz	
In a 100 $\Omega$ system	Symmetrical		
General data			
Dimensions W/H/D		17.7 mm / 90 mm / 65.5 mm	
Temperature range		-40 °C ... 85 °C	
Connection method		Screw connection (in connection with the base element)	
Test standards		EN 61643-21/A1 / IEC 61643-21/A1	

#### Ordering data

Description	Nominal voltage $U_N$	Type	Order No.	Pcs./Pkt.
PLUGTRAB plug, with protective circuit for inserting in PT base element	5 V DC 12 V DC	PT 3-PB-ST PT 3-HF-12DC-ST	2858030 2858043	10 10
PLUGTRAB base element, for mounting on NS 35	Bridge between 3/4 ( $\frac{1}{2}$ ) and 9/10	PT 1X2-BE	2856113	10
DATATRAB, protective device for PROFIBUS DP applications with up to 12 Mbps				

#### Accessories

Shield fast connection	Order No.	Pcs./Pkt.
For $\varnothing$ 3-6 mm	2839295	10
For $\varnothing$ 5-10 mm	2839512	10



**Pluggable arrester with screw connection, for five conductors, with common reference potential**



**PROFIBUS fine protection with D-SUB 9**

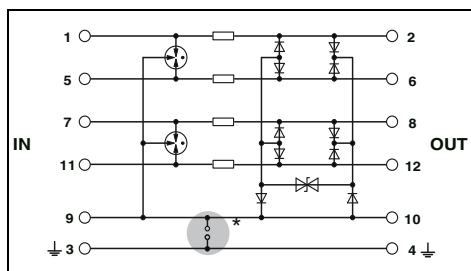

### Technical data

C1 / C2 / C3 / D1  
14 V DC / 9.8 V AC  
450 mA (45°C)

10 kA / 20 kA (in total)  
20 kA

≤ 50 V (C3 - 25 A) / ≤ 50 V (C3 - 25 A)

≤ 25 V / ≤ 25 V (with PT 2X2-BE)

typ. 60 MHz

17.7 mm / 90 mm / 65.5 mm  
-40 °C ... 85 °C  
Screw connection (in connection with the base element)

EN 61643-21 / IEC 61643-21

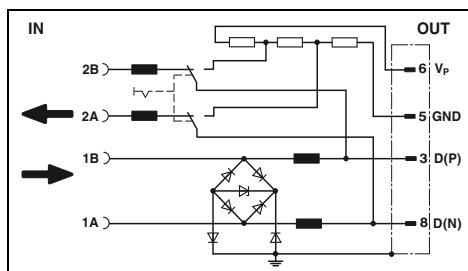

### Technical data

C1 / C3 / B2  
5.2 V DC / -  
250 mA (25 °C)

350 A / 350 A  
350 A

≤ 25 V (C1 - 500 V / 250 A) / ≤ 25 V (C1 - 500 V / 250 A)

≤ 14 V / ≤ 14 V

typ. 70 MHz

44.5 mm / 58 mm / 16.6 mm  
-20 °C ... 75 °C  
Screw connection & D-SUB-9

IEC 61643-21

### Ordering data

Type	Order No.	Pcs./Pkt.
PT 5-HF-12 DC-ST	2838775	10
PT 2X2-BE	2839208	10

### Accessories

SSA 3-6	2839295	10
SSA 5-10	2839512	10

### Ordering data

Type	Order No.	Pcs./Pkt.
D-UFB-PB	2880642	1

### Accessories

--	--	--

### PROFIBUS PA fieldbus system

#### TERMITRAB complete

- One-piece or pluggable surge protection
- Tailored to the special requirements of intrinsically safe circuits
- Overall width of just 6.2 mm
- Integrated mechanical status indicator
- Impedance-neutral insertion and removal
- Coded connector versions
- With knife disconnection
- Plugs can be tested with CHECKMASTER 2

#### PLUGTRAB PT-IQ-EX

- Tailored to the special requirements of intrinsically safe circuits
- Multi-stage status monitoring
- Group message via supply and remote signaling module
- Multi-stage, floating remote signaling
- System supplied via DIN rail bus
- Up to 10 protection modules per supply module
- Maximum ease of maintenance thanks to the two-piece design
- Plugs are coded
- Impedance-neutral disconnection of plug for maintenance purposes
- Base element remains an integral part of the installation
- Corresponding replacement plugs can be found on our website

#### PLUGTRAB PT 2XEX(I)

- Tailored to the special requirements of intrinsically safe circuits
- Consistently pluggable signal circuit protection
- Maximum ease of maintenance thanks to the two-piece design
- Base element remains an integral part of the installation
- Impedance-neutral disconnection of plug for test and maintenance purposes
- Plugs can be checked with CHECKMASTER



new

3-conductor with common reference potential, intrinsically safe, one-piece

Ex:

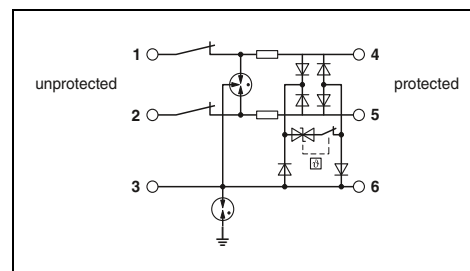

Electrical data	
IEC test classification/EN type	... 12DC
Maximum continuous operating voltage $U_c$	C1 / C2 / C3 / D1
Rated current	15 V DC
Pulse discharge current $I_{mp}$ (10/350) $\mu$ s	600 mA (40°C)
Nominal discharge current $I_n$ (8/20) $\mu$ s	0.5 kA
Total discharge current $I_{total}$ (8/20) $\mu$ s	Core-Core / Core-Ground
Protection level $U_p$	5 kA / 5 kA
	10 kA
	Core-Core
	$\leq 145$ V (C1 - 1 kV/500 A)
	Core-Ground
	$\leq 750$ V (C1 - 1 kV/500 A)
	Core-GND
	$\leq 80$ V (C1 - 1 kV/500 A)
Cut-off frequency $f_g$ (3 dB)	Symmetrical in the 150 $\Omega$ system
Resistance per path	typ. 60 MHz
General data	1.65 $\Omega$
Dimensions W/H/D	
Connection data solid/stranded/AWG	
Temperature range	
Test standards	

Technical data	
... 12DC	... 24DC
C1 / C2 / C3 / D1	C1 / C2 / C3 / D1
15 V DC	30 V DC
600 mA (40°C)	600 mA (40°C)
0.5 kA	0.5 kA
5 kA / 5 kA	5 kA / 5 kA
10 kA	10 kA
$\leq 145$ V (C1 - 1 kV/500 A)	$\leq 150$ V (C1 - 1 kV/500 A)
$\leq 750$ V (C1 - 1 kV/500 A)	$\leq 750$ V (C1 - 1 kV/500 A)
$\leq 80$ V (C1 - 1 kV/500 A)	$\leq 80$ V (C1 - 1 kV/500 A)
typ. 60 MHz	typ. 60 MHz
1.65 $\Omega$	1.65 $\Omega$
	6.2 mm / 105.8 mm / 83.5 mm
	0.2...4 mm <sup>2</sup> / 0.2...2.5 mm <sup>2</sup> / 24 ... 12
	-40 °C ... 85 °C
	EN 60079-0 / EN 60079-11 / EN 61643-21 / IEC 60079-0 / IEC 60079-11 / IEC 61643-21

Description	Voltage $U_N$
<b>TERMITRAB complete</b> , with screw connection technology	
	12 V DC
	24 V DC
<b>MCR-PLUGTRAB</b> , with screw connection technology	24 V DC
<b>PLUGTRAB plug</b> , with protective circuit for plugging into the PT base element	24 V DC
<b>PLUGTRAB base element</b> , for mounting on NS 35	
	24 V DC

Ordering data		
Type	Order No.	Pcs./Pkt.
TTC-6-3-HF-F-M-EX-12DC-UT-I	2906822	1
TTC-6-3-HF-F-M-EX-24DC-UT-I	2906823	1

# Surge protection and interference suppression filters

## Surge protection for information technology and telecommunications

new



SIL  
evaluated  
IEC 61508

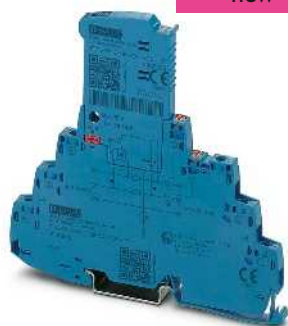

3-conductor with common reference potential, intrinsically safe, pluggable

Ex:



SIL  
evaluated  
IEC 61508



Double wire (loop), floating, connection 9/10 grounded directly, e.g., for 4 ... 20 mA current loop

Ex:



SIL  
evaluated  
IEC 61508



Double wire protection for two intrinsically safe circuits

Ex:

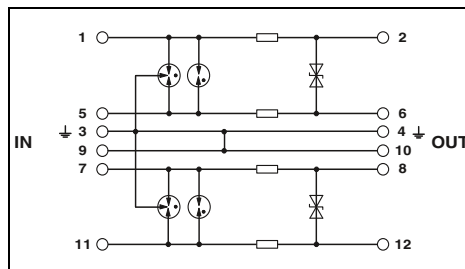
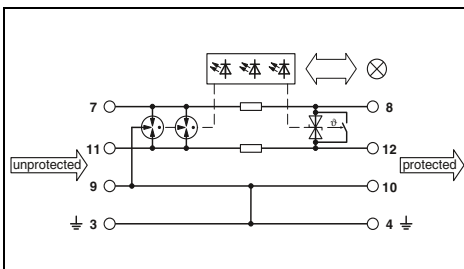
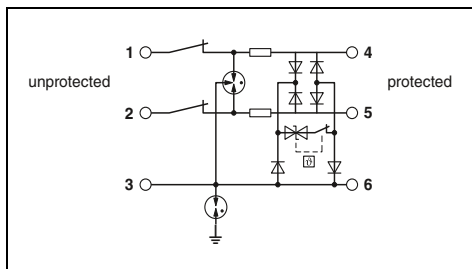

Technical data	
... 12DC	... 24DC
C1 / C2 / C3 / D1	C1 / C2 / C3 / D1
15 V DC	30 V DC
600 mA (40°C)	600 mA (40°C)
0.5 kA	0.5 kA
5 kA / 5 kA	5 kA / 5 kA
10 kA	10 kA
≤ 95 V (C1 - 1 kV/500 A)	≤ 150 V (C1 - 1 kV/500 A)
≤ 1.1 kV (C1 - 1 kV/500 A)	≤ 750 V (C1 - 1 kV/500 A)
≤ 95 V (C1 - 1 kV/500 A)	≤ 80 V (C1 - 1 kV/500 A)
typ. 60 MHz	typ. 60 MHz
1.65 Ω	1.65 Ω
6.2 mm / 105.8 mm / 100 mm	
0.2...4 mm <sup>2</sup> / 0.2...2.5 mm <sup>2</sup> / 24 ... 12	
-40 °C ... 85 °C	
EN 60079-0 / EN 60079-11 / EN 61643-21 / IEC 60079-0 / IEC 60079-11 / IEC 61643-21	

Technical data	
C1 / C2 / C3 / D1	
30 V DC / 21 V AC	
350 mA	
2 kA	
10 kA / 10 kA	
20 kA	
≤ 60 V (C1 - 1 kV/500 A)	
≤ 1.3 kV (C2 - 10 kV / 5 kA)	
-	
typ. 1.1 MHz	
1.2 Ω	
17.7 mm / 91.1 mm / 77.5 mm	
0.2...4 mm <sup>2</sup> / 0.2...2.5 mm <sup>2</sup> / 24 ... 12	
-40 °C ... 70 °C	
EN 61643-21/A2 / IEC 61643-21/A2 / EN 61000-6-2 / EN 61000-6-3/A1	

Technical data	
C1 / C2 / C3 / D1	
30 V DC / 21 V AC	
325 mA (40°C)	
2 kA	
10 kA / 10 kA	
20 kA	
≤ 45 V (C1 - 0.5 kV / 250 A)	
≤ 1 kV (C1 - 1 kV/500 A)	
-	
typ. 1.6 MHz	
2.2 Ω	
17.7 mm / 90 mm / 65.5 mm	
0.2...4 mm <sup>2</sup> / 0.2...2.5 mm <sup>2</sup> / 24 ... 12	
-40 °C ... 85 °C	
EN 61643-21 / EN 60079-0 / EN 60079-11 / EN 60079-26 / IEC 60079-0 / IEC 60079-11	

Ordering data		
Type	Order No.	Pcs./Pkt.
TTC-6P-3-HF-F-M-EX-12DC-UT-I	2906826	1
TTC-6P-3-HF-F-M-EX-24DC-UT-I	2906828	1

Ordering data		
Type	Order No.	Pcs./Pkt.
PT-IQ-1X2-EX-24DC-UT	2801512	1

Ordering data		
Type	Order No.	Pcs./Pkt.
PT 2XEX(I)-24DC-ST	2838225	10
PT 2XEX(I)-BE	2839279	10

# Surge protection and interference suppression filters

## Surge protection for information technology and telecommunications

### INTERBUS remote bus

#### PLUGTRAB PT-IQ 5-HF

- Surge protection system
- Group message via supply and remote signaling module
- Multi-stage, floating remote signaling
- System supplied via DIN rail bus
- Base element with screw connection technology

#### PLUGTRAB PT 5-HF

- High transmission speed
- Fast response time
- High discharge capacity
- Plugs can be checked with CHECKMASTER

#### DATATRAB DT-UFB-IB-RBI/ -RBO

- Adapter type
- 9-pos. D-SUB connection
- For remote bus modules
- DIN rail mounting possible by removing the cap
- D-SUB cable included

\* **Note:PT .x.+F-BE** connections 9/10 (GND) are linked to the mounting foot via a gas-filled surge arrester.

#### Notes:

For approvals and dimensional drawing, visit [phoenixcontact.net/products](http://phoenixcontact.net/products)



Pluggable arrester with screw connection, for five conductors, with common reference potential

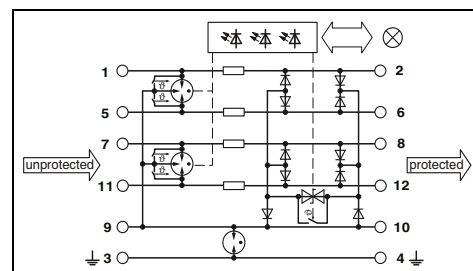

#### Technical data

Electrical data	
IEC test classification/EN type	C1 / C2 / C3 / D1
Maximum continuous operating voltage $U_c$	6 V DC / 4 V AC
Rated current	600 mA (40°C)
Nominal discharge current $I_n$ (8/20) $\mu$ s	
	Core-Core / Core-Ground
Total discharge current $I_{total}$ (8/20) $\mu$ s	10 kA / 10 kA
Protection level $U_p$	20 kA
	Core-Core / Core-Ground
	$\leq 30$ V (C3 - 25 A) / $\leq 900$ V (C3 - 25 A)
Cut-off frequency fg (3 dB)	-
In a 100 $\Omega$ system	Symmetrical
In a 150 $\Omega$ system	Symmetrical
General data	
Dimensions W/H/D	17.7 mm / 91 mm / 77.5 mm
Temperature range	-40 °C ... 70 °C
Connection method	Screw connection
Test standards	IEC 61643-21 / EN 61643-21 / EN 61000-6-2 /

#### Ordering data

Description	Nominal voltage $U_N$	Type	Order No.	Pcs./Pkt.
<b>MCR-PLUGTRAB</b> , consisting of a plug, base element, and DIN rail bus, with screw connection technology				
	5 V DC	<b>PT-IQ-5-HF+F-5DC-UT</b>	<b>2800798</b>	1
<b>PLUGTRAB plug</b> , with protective circuit for plugging into the PT base element				
<b>PLUGTRAB base element</b> , for mounting on NS 35				
Gas-filled surge arrester between 3/4 ( $\downarrow$ ) and 9/10				
<b>DATATRAB adapter</b> , protective adapter for inserting into the data line				

#### Accessories

<b>PLUGTRAB</b> , supply and remote signaling module				
Screw connection technology		<b>PT-IQ-PTB-UT</b>	<b>2800768</b>	1
Push-in connection technology		<b>PT-IQ-PTB-PT</b>	<b>2801296</b>	1

# Surge protection and interference suppression filters

## Surge protection for information technology and telecommunications



Pluggable arrester with screw connection, for five conductors, with common reference potential



Protective adapter for 5-wire remote bus input



Protective adapter for 5-wire remote bus output

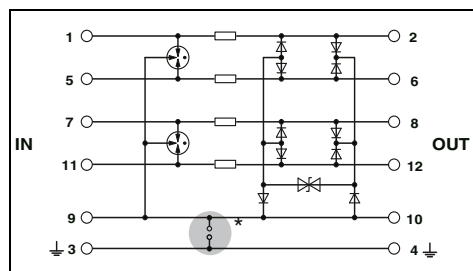

### Technical data

C1 / C2 / C3 / D1  
5.2 V DC / 3.6 V AC  
450 mA (45 °C)

10 kA / 10 kA  
20 kA

≤ 45 V (C3 - 25 A) / ≤ 45 V (C3 - 25 A)

typ. 60 MHz  
-

17.7 mm / 90 mm / 65.5 mm  
-40 °C ... 85 °C  
Screw connection (in connection with the base element)

EN 61643-21/A1 / IEC 61643-21/A1

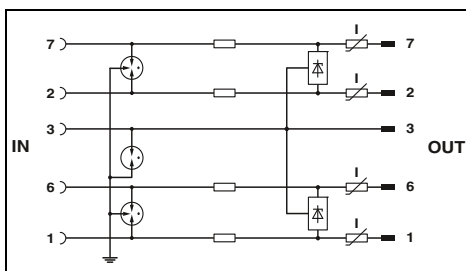

### Technical data

B2 / C1 / C2 / C3 / D1  
5.8 V DC / -  
≤ 180 mA (25 °C)

≤ 5 kA / ≤ 5 kA  
10 kA

≤ 20 V (C1 - 500 A) / ≤ 700 V (C1 - 500 A)

≥ 100 MHz  
≥ 100 MHz

25 mm / 110 mm / 63 mm  
-40 °C ... 85 °C  
D-SUB-9

DIN EN 61643-21 / IEC 61643-21

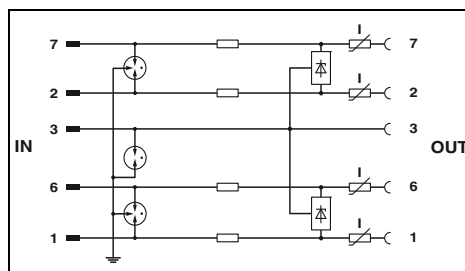

### Technical data

B2 / C1 / C2 / C3 / D1  
5.8 V DC / -  
≤ 180 mA (25 °C)

≤ 5 kA / ≤ 5 kA  
10 kA

≤ 20 V (C1 - 500 A) / ≤ 700 V (C1 - 500 A)

≥ 100 MHz  
≥ 100 MHz

25 mm / 110 mm / 63 mm  
-40 °C ... 85 °C  
D-SUB-9

DIN EN 61643-21 / IEC 61643-21

### Ordering data

Type	Order No.	Pcs./Pkt.
PT 5-HF-5 DC-ST	2838762	10
PT 2X2+F-BE	2839224	10

### Accessories

--	--	--

### Ordering data

Type	Order No.	Pcs./Pkt.
DT-UFB-IB-RB0	2800056	1

### Accessories

--	--	--

### Ordering data

Type	Order No.	Pcs./Pkt.
DT-UFB-IB-RBI	2800055	1

### Accessories

--	--	--

# Surge protection and interference suppression filters

## Surge protection for information technology and telecommunications

### MCR-PLUGTRAB, for various applications

- Protection for fieldbus systems and signal circuits with three to five-conductor technology
- Cable shield connection using SSA... shield fast connection
- Maximum ease of maintenance thanks to the two-piece design
- Base element remains an integral part of the installation
- Impedance-neutral disconnection of plug for test and maintenance purposes

**\* Note:**

Various grounding options for the base elements:

**PT .x.-BE** connections 9/10 (GND) directly connected to the mounting foot.

**PT .x.+F-BE** connections 9/10 (GND) connected to the mounting foot via a gas-filled surge arrester.

<b>Notes:</b>
Attenuation characteristics at <a href="http://phoenixcontact.net/products">phoenixcontact.net/products</a>



**5-wire protection  
for fieldbus and serial interface**

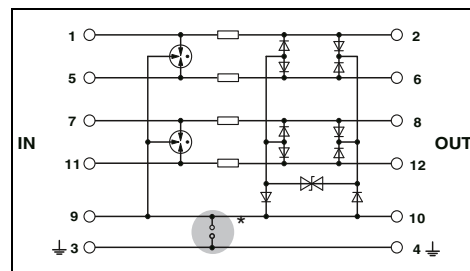

Electrical data	
IEC test classification/EN type	... 5DC / ... 12DC / ... 24DC C1 / C2 / C3 / D1
Maximum continuous operating voltage $U_c$	5.2 V DC / 3.6 V AC / 14 V DC / 9.8 V AC / 28 V DC
Rated current	450 mA (45°C)
Pulse discharge current $I_{imp}$ (10/350) $\mu$ s	2.5 kA
Nominal discharge current $I_n$ (8/20) $\mu$ s	10 kA / 10 kA / 10 kA / 20 kA (in total) / 10 kA (with PT 2X2+F-BE)
Total discharge current $I_{total}$ (8/20) $\mu$ s	20 kA
Max. discharge current $I_{max}$ (8/20) $\mu$ s	10 kA
Output voltage limitation at 1 kV/ $\mu$ s	Core-Core $\leq$ 15 V / Core-Ground $\leq$ 15 V
Cut-off frequency $f_g$ (3 dB)	Symmetrical in the 100 $\Omega$ system
Resistance per path	typ. 60 MHz / 2.2 $\Omega$
General data	
Dimensions W/H/D	17.7 mm / 90 mm / 65.5 mm
Connection data solid/stranded/AWG	0.2...4 mm <sup>2</sup> / 0.2...2.5 mm <sup>2</sup> / 24 ... 12
Temperature range	-40 °C ... 85 °C
Test standards	EN 61643-21/A1 / IEC 61643-21/A1

Technical data		
... 5DC	... 12DC	... 24DC
C1 / C2 / C3 / D1	C1 / C2 / C3 / D1	C1 / C2 / C3 / D1
5.2 V DC / 3.6 V AC	14 V DC / 9.8 V AC	28 V DC
450 mA (45°C)	450 mA (45°C)	450 mA (45°C)
2.5 kA	2.5 kA	2.5 kA
10 kA / 10 kA	10 kA / 20 kA (in total)	10 kA / 10 kA (with PT 2X2+F-BE)
20 kA	20 kA	20 kA
10 kA	20 kA (in total)	-
$\leq$ 15 V	$\leq$ 25 V	-
$\leq$ 15 V	$\leq$ 25 V (with PT 2X2-BE)	-
typ. 60 MHz	typ. 60 MHz	typ. 70 MHz
2.2 $\Omega$	2.2 $\Omega$	2.2 $\Omega$

Description	Voltage $U_N$
<b>PLUGTRAB plug</b> , with protective circuit for inserting in PT base element	5 V DC 12 V DC 24 V DC 32 V DC
<b>PLUGTRAB base element</b> , for mounting on NS 35	
Bridge between 3/4 ( $\perp$ ) and 9/10	
Gas-filled surge arrester between 3/4 ( $\perp$ ) and 9/10	

Ordering data		
Type	Order No.	Pcs./Pkt.
<b>PT 5-HF- 5 DC-ST</b>	<b>2838762</b>	10
<b>PT 5-HF-12 DC-ST</b>	<b>2838775</b>	10
<b>PT 5-HF-24DC-ST</b>	<b>2906002</b>	1
<b>PT 2X2-BE</b>	<b>2839208</b>	10
<b>PT 2X2+F-BE</b>	<b>2839224</b>	10

Shield fast connection	
For $\varnothing$ 3-6 mm	
For $\varnothing$ 5-10 mm	

Accessories		
<b>SSA 3-6</b>	<b>2839295</b>	10
<b>SSA 5-10</b>	<b>2839512</b>	10



**2 x 2-wire protection  
for 2-wire bus system**



**2 x 2-wire protection  
for FOUNDATION Fieldbus**

ERC  
Ex:

ERC  
Ex:

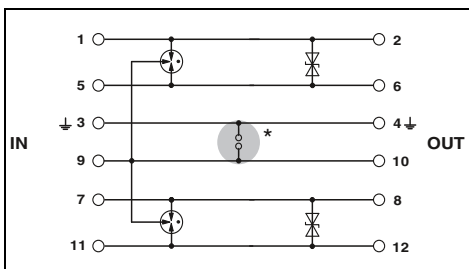
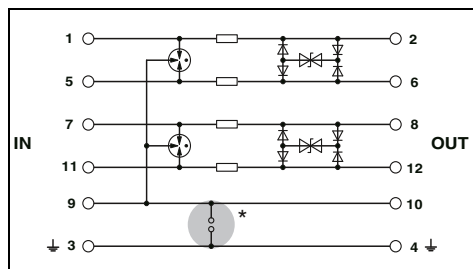

### Technical data

### Technical data

... 5DC	... 12DC	... 24DC
C1 / C2 / C3 / D1	C1 / C2 / C3 / D1	C1 / C2 / C3 / D1
5.2 V DC / 3.6 V AC	13 V DC / 9 V AC	28 V DC / 19.8 V AC
450 mA (45°C)	450 mA (45°C)	450 mA (45°C)
2.5 kA	2.5 kA	2.5 kA
10 kA / 10 kA	10 kA / 10 kA	10 kA / 10 kA
20 kA / 10 kA	20 kA / 10 kA	20 kA / 10 kA
≤ 15 V	≤ 25 V	≤ 45 V
-	-	-
typ. 70 MHz	typ. 70 MHz	typ. 70 MHz
2.2 Ω	2.2 Ω	2.2 Ω

C1 / C2 / C3 / D1
36 V DC
1.6 A
1 kA
100 A / 10 kA
-
10 kA
≤ 75 V
-
-
1 Ω

17.7 mm / 45 mm / 52 mm  
0.2...4 mm<sup>2</sup> / 0.2...2.5 mm<sup>2</sup> / 24 ... 12  
-40 °C ... 85 °C  
IEC 61643-21

17.7 mm / 90 mm / 65.5 mm  
- mm<sup>2</sup> / - mm<sup>2</sup> / -  
-40 °C ... 85 °C  
EN 61643-21/A1

### Ordering data

### Ordering data

Type	Order No.	Pcs./Pkt.
PT 2X2-HF-5 DC-ST	2839567	10
PT 2X2-HF-12 DC-ST	2839570	10
PT 2X2-HF-24 DC-ST	2839729	10
PT 2X2-BE	2839208	10
PT 2X2+F-BE	2839224	10

Type	Order No.	Pcs./Pkt.
PT 2X2-FF-ST	2800755	10
PT 4-BE	2839402	10
PT 4+F-BE	2839415	10

### Accessories

### Accessories

SSA 3-6	2839295	10
SSA 5-10	2839512	10

SSA 3-6	2839295	10
SSA 5-10	2839512	10

# Surge protection and interference suppression filters

## Surge protection for information technology and telecommunications

### DSL telecommunications

#### DATATRAB DT

- Protection for two DSL ports
- Connection: RJ45 (RJ12/RJ11) and plug-in screw terminal block (COMBICON)
- Alternatively, can be snapped onto a DIN rail
- Protective circuit:
  - Course/fine protection combination between all cables of signal wire pairs, as well as common mode voltage coarse protection between all signal wires and ground
- Separate ground connection line
- The adapter included enables conversion from RJ45 to RJ11 and RJ12 (for contacting, see circuit diagram)



Attachment plug for two VDSL interfaces (ports)



Attachment plug for two SHDSL interfaces (ports)

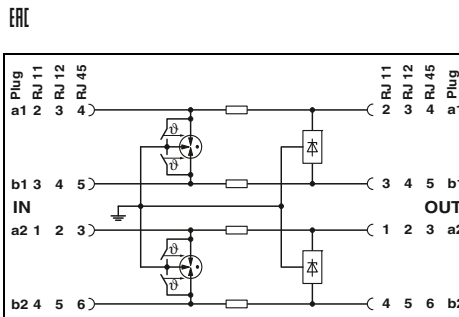

#### Technical data

Electrical data	
IEC test classification/EN type	B2 / C1 / C2 / C3 / D1
Maximum continuous operating voltage $U_C$	185 V DC
Rated current	$\leq 380$ mA (25 °C)
Nominal discharge current $I_n$ (8/20) $\mu$ s	Core-Core / Core-Ground $\leq 5$ kA / $\leq 5$ kA
Total discharge current $I_{total}$ (8/20) $\mu$ s	10 kA
Protection level $U_p$	Core-Core / Core-Ground $\leq 250$ V (C1 - 1 kV/500 A) / $\leq 250$ V (C1 - 1 kV/500 A)
Cut-off frequency $f_g$ (3 dB)	Core-Core typ. 50 MHz
In a 100 $\Omega$ system	
General data	
Dimensions W/H/D	25 mm / 102 mm / 63.5 mm
Connection data solid/stranded/AWG	0.14...1.5 mm <sup>2</sup> / 0.14...1.5 mm <sup>2</sup> / 28 ... 16
Temperature range	-40 °C ... 85 °C
Connection method	RJ45/COMBICON
Test standards	IEC 61643-21 / EN 61643-21

#### Ordering data

DATATRAB, protective adapter for insertion in the data cable			
DT-TELE-RJ45	2882925	1	

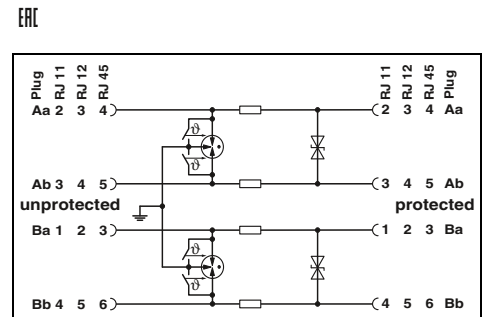

#### Technical data

Electrical data	
IEC test classification/EN type	B2 / C1 / C2 / C3 / D1
Maximum continuous operating voltage $U_C$	185 V DC
Rated current	$\leq 380$ mA (25 °C)
Nominal discharge current $I_n$ (8/20) $\mu$ s	Core-Core / Core-Ground $\leq 5$ kA / $\leq 5$ kA
Total discharge current $I_{total}$ (8/20) $\mu$ s	10 kA
Protection level $U_p$	Core-Core / Core-Ground $\leq 250$ V (C1 - 500 A) / $\leq 580$ V (C1 - 500 A)
Cut-off frequency $f_g$ (3 dB)	25 MHz
In a 100 $\Omega$ system	
General data	
Dimensions W/H/D	25 mm / 103 mm / 63 mm
Connection data solid/stranded/AWG	0.14...1.5 mm <sup>2</sup> / 0.14...1.5 mm <sup>2</sup> / 28 ... 16
Temperature range	-40 °C ... 85 °C
Connection method	RJ45/COMBICON
Test standards	IEC 61643-21

#### Ordering data

DATATRAB, protective adapter for insertion in the data cable			
DT-TELE-SHDSL	2801593	1	

### DSL telecommunications

#### PLUGTRAB PT-IQ

- Multi-stage status monitoring
- Group message via supply and remote signaling module
- Multi-stage, floating remote signaling
- System supplied via DIN rail bus
- Up to 28 protection modules per supply module
- Maximum ease of maintenance thanks to the two-piece design
- Plugs are coded
- Impedance-neutral disconnection of plug for maintenance purposes
- PT-IQ...-UT base element with screw connection technology
- PT-IQ...-PT base element with Push-in connection technology
- Base element remains an integral part of the installation
- Corresponding replacement plugs can be found on our website



**Double wire (loop), floating, connection 9/10 grounded directly, e.g., for DSL applications**

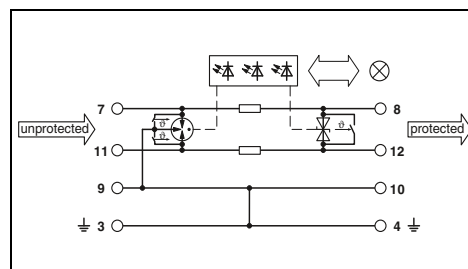

#### Technical data

<b>Electrical data</b>		C1 / C2 / C3 / D1 / B2
IEC test classification/EN type		180 V DC
Maximum continuous operating voltage $U_c$		150 mA (25 °C)
Rated current		2.5 kA
Pulse discharge current $I_{imp}$ (10/350) $\mu$ s		Core-Core / Core-Ground
Nominal discharge current $I_n$ (8/20) $\mu$ s		
Total discharge current $I_{total}$ (8/20) $\mu$ s		20 kA
Protection level $U_p$		Core-Core $\leq$ 290 V (C3 - 50 A)
		Core-Ground $\leq$ 700 V (C3 - 50 A)
Cut-off frequency $f_g$ (3 dB)		Symmetrical in the 150 $\Omega$ system
Resistance per path		typ. 25 MHz 1.2 $\Omega$
<b>General data</b>		
Dimensions W/H/D		17.7 mm / 91.1 mm / 77.5 mm
Connection data solid/stranded/AWG		0.2...4 mm <sup>2</sup> / 0.2...2.5 mm <sup>2</sup> / 24 ... 12
Temperature range		-40 °C ... 70 °C
Test standards		IEC 61643-21 / EN 61643-21 / EN 61000-6-2 / EN 61000-6-3
<b>Remote indication contact</b>		Via TBUS

#### Ordering data

Description	Type	Order No.	Pcs./Pkt.
<b>DATA-PLUGTRAB</b>			
Screw connection technology	PT-IQ-1X2-TELE-UT	2800769	1
Push-in connection technology	PT-IQ-1X2-TELE-PT	2801290	1

#### Accessories

<b>Replacement plug</b>			
PLUGTRAB, supply and remote signaling module			
Screw connection technology	PT-IQ-PTB-UT	2800768	1
Push-in connection technology	PT-IQ-PTB-PT	2801296	1

# Surge protection and interference suppression filters

## Surge protection for information technology and telecommunications

### DSL telecommunications

#### PT 2-TELE

- For analog telecommunications
- Two-piece, pluggable
- Universal use
- High discharge capacity
- Plugs can be checked with CHECKMASTER

**Notes:**  
Attenuation characteristics at phoenixcontact.net/products



**3-wire protection for DSL (ISDN  $U_{k0}$ ) applications with common reference potential**

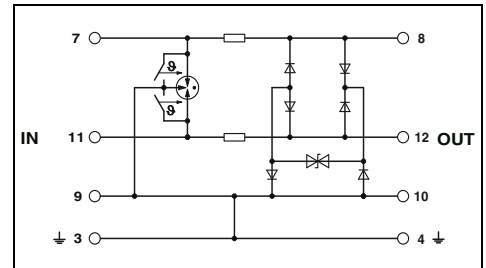

Electrical data	
IEC test classification/EN type	B2 / C1 / C2 / C3 / D1
Maximum continuous operating voltage $U_c$	185 V DC / 130 V AC
Rated current	450 mA AC (45°C)
Pulse discharge current $I_{imp}$ (10/350) $\mu$ s	1 kA
Nominal discharge current $I_n$ (8/20) $\mu$ s	10 kA / 10 kA
	Core-Core / Core-Ground
Total discharge current $I_{total}$ (8/20) $\mu$ s	18 kA
Max. discharge current $I_{max}$ (8/20) $\mu$ s	18 kA
Output voltage limitation at 1 kV/ $\mu$ s	Core-Core $\leq$ 300 V
	Core-Ground $\leq$ 300 V
Cut-off frequency $f_g$ (3 dB)	typ. 20 MHz
	Symmetrical in the 100 $\Omega$ system
Resistance per path	2.2 $\Omega$

#### Technical data

B2 / C1 / C2 / C3 / D1  
185 V DC / 130 V AC  
450 mA AC (45°C)  
1 kA

10 kA / 10 kA  
18 kA  
18 kA

$\leq$  300 V  
 $\leq$  300 V

typ. 20 MHz  
2.2  $\Omega$

General data	
Dimensions W/H/D	17.7 mm / 90 mm / 65.5 mm
Connection data solid/stranded/AWG	0.2...4 mm <sup>2</sup> / 0.2...2.5 mm <sup>2</sup> / 24 ... 12
Temperature range	-40 °C ... 85 °C
Test standards	IEC 61643-21 / EN 61643-21

#### Ordering data

Description
<b>DATA-PLUGTRAB</b> , consisting of plug and base element

Type	Order No.	Pcs./Pkt.
PT 2-TELE	2882828	10

Replacement plug
<b>Shield fast connection</b> For $\varnothing$ 3-6 mm For $\varnothing$ 5-10 mm

#### Accessories

PT 2-TELE-ST	2838733	10
SSA 3-6	2839295	10
SSA 5-10	2839512	10

**DSL telecommunications**

- For surface mounting
- Three TAE6 slots
- For two N-coded and one F-coded terminal devices
- Suitable for ADSL and VDSL
- Main areas of application: Phone terminals, answering machines, modems, and fax machines



**TAE outlet box for VDSL (NFN)**

ERIC

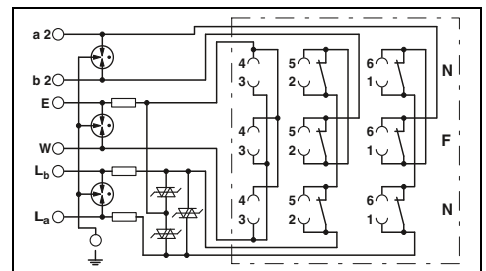

**Technical data**

Electrical data		
IEC test classification/EN type		B2 / C1 / C2 / C3 / D1
Nominal voltage $U_N$		60 V DC
Maximum continuous operating voltage $U_C$		185 V DC
Rated current		450 mA ( $\leq 40^\circ\text{C}$ )
Nominal discharge current $I_n$ (8/20) $\mu\text{s}$	Core-Core / Core-Ground	5 kA / 5 kA
Total discharge current $I_{\text{total}}$ (8/20) $\mu\text{s}$		10 kA
Protection level $U_p$	Core-Core / Core-Ground	$\leq 250 \text{ V}$ (C2 - 10 kV / 5 kA) / $\leq 500 \text{ V}$ (C2 - 10 kV / 5 kA)
Output voltage limitation at 1 kV/ $\mu\text{s}$	Core-Core / Core-Ground	$\leq 250 \text{ V}$ / $\leq 450 \text{ V}$
Cut-off frequency $f_g$ (3 dB)		typ. 2 MHz
In a 600 $\Omega$ system	Core-Core	
General data		
Dimensions W/H/D		65 mm / 27 mm / 80 mm
Temperature range		$-40^\circ\text{C} \dots 80^\circ\text{C}$
Connection method		Screw connection & TAE 6
Test standards		DIN EN 61643-21 / IEC 61643-21

**Ordering data**

Description	For country-specific use in	Type	Order No.	Pcs./Pkt.
<b>TAE outlet box (NFN)</b> with surge protection for analog telecommunications interfaces				
Surface-mounted socket	D	<b>TAE-TRAB FM-NFN-AP</b>	<b>2749628</b>	1

# Surge protection and interference suppression filters

## Surge protection for information technology and telecommunications

### For telecommunications and measurement and control interfaces COMTRAB modular

- Space-saving LSA-PLUS connection technology
- Can be used in LSA-PLUS disconnect and control strips or CT-TERMIBLOCK
- The CTM 10-MAG surge protection magazine can be fitted with ten different protective plugs



Double wire (loop), floating



2-wire, with common reference potential

ERIC

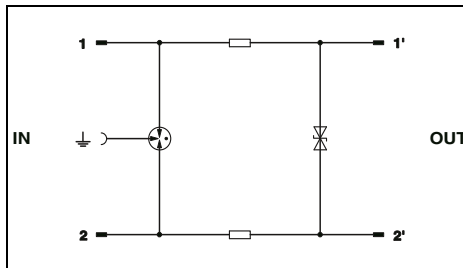

ERIC

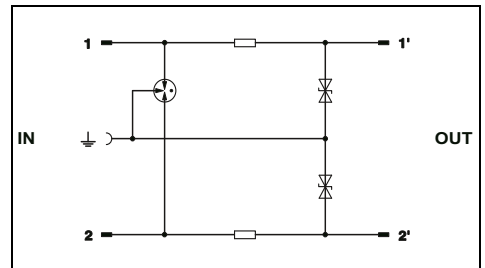

#### Technical data

Electrical data	... 110AC
IEC test classification/EN type	B2 / C1 / C2 / C3 / D1
Maximum continuous operating voltage $U_C$	60 V DC / 125 V AC
Rated current	380 mA AC (25 °C)
Pulse discharge current $I_{imp}$ (10/350) $\mu$ s	1 kA
Nominal discharge current $I_n$ (8/20) $\mu$ s	
	Core-Core / Core-Ground
Total discharge current $I_{total}$ (8/20) $\mu$ s	5 kA / 5 kA
Protection level $U_p$	10 kA
	Core-Core
	Core-Ground
	$\leq 260$ V (C3 - 100 A)
	$\leq 800$ V (C3 - 100 A)
Cut-off frequency $f_g$ (3 dB)	
	typ. 20 MHz / -
	Symmetrical/asymmetrical in the 100 $\Omega$ system
Resistance per path	3.3 $\Omega$
General data	
Dimensions W/H/D	9.4 mm / 21 mm / 52.4 mm
Temperature range	-25 °C ... 75 °C
Test standards	IEC 61643-21 / EN 61643-21

#### Technical data

Electrical data	... 110AC
IEC test classification/EN type	B2 / C1 / C2 / C3 / D1
Maximum continuous operating voltage $U_C$	60 V DC / 125 V AC
Rated current	380 mA AC (25 °C)
Pulse discharge current $I_{imp}$ (10/350) $\mu$ s	1 kA
Nominal discharge current $I_n$ (8/20) $\mu$ s	
	Core-Core / Core-Ground
Total discharge current $I_{total}$ (8/20) $\mu$ s	- / 5 kA
Protection level $U_p$	10 kA
	Core-Core
	Core-Ground
	$\leq 260$ V (C3 - 100 A)
Cut-off frequency $f_g$ (3 dB)	
	- / typ. 20 MHz
	Symmetrical/asymmetrical in the 100 $\Omega$ system
Resistance per path	3.3 $\Omega$
General data	
Dimensions W/H/D	9.4 mm / 21 mm / 52.4 mm
Temperature range	-25 °C ... 75 °C
Test standards	IEC 61643-21 / EN 61643-21

#### Ordering data

Description	Voltage $U_N$
<b>COMTRAB modular</b> , surge protection for a double wire with coarse and fine protection and ohmic decoupling, DSL-compatible	110 V AC 180 V DC
<b>COMTRAB modular</b> , surge protection for the ISDN $S_0$ interface	6 V DC

Type	Order No.	Pcs./Pkt.
CTM 1X2-110AC	2838539	10

#### Ordering data

Type	Order No.	Pcs./Pkt.
CTM 2X1-110AC	2838526	10

#### Accessories

<b>Magazine</b> , with grounding rail for accommodating up to 10 LSA-PLUS protective plugs (CTM...), for insertion in CT-TERMIBLOCK or LSA-PLUS disconnect strip	
<b>Grounding connector</b>	

CTM 10-MAG	2838610	5
CTM EST	2838649	10

#### Accessories

CTM 10-MAG	2838610	5
CTM EST	2838649	10

# Surge protection and interference suppression filters

## Surge protection for information technology and telecommunications



2-wire, with common reference potential



2-wire, coarse protection, with failsafe contact



2-wire, coarse protection, with failsafe contact and current protection (Powercross)

ERIC

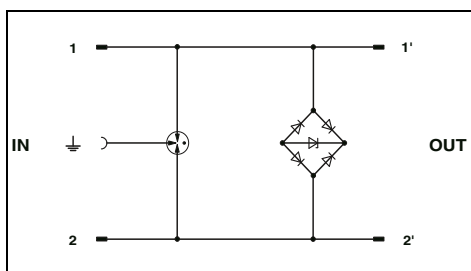

### Technical data

B2 / C2 / C3 / D1 / C1  
 ± 6 V DC  
 1.5 A (25 °C)  
 1 kA  
 350 A / 5 kA  
 10 kA  
 ≤ 18 V (C3, 7.5 kV/100 A)  
 ≤ 700 V (C3 - 7.5 kV / 100 A, spike)  
 ≥ 100 MHz / -  
 -

9.5 mm / 21 mm / 53.5 mm  
 -25 °C ... 75 °C  
 IEC 61643-21

### Ordering data

Type	Order No.	Pcs./Pkt.
CTM ISDN	2838555	10

### Accessories

CTM 10-MAG	2838610	5
CTM EST	2838649	10

ERIC

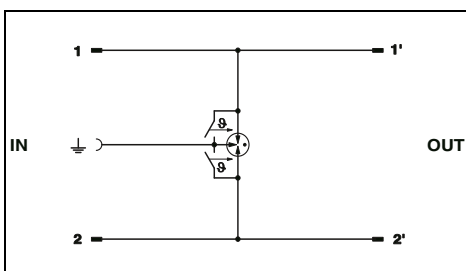

### Technical data

A2 / B1 / B2 / B3 / C1 / C2 / C3 / D1 / D2  
 ± 180 V DC  
 1.5 A (25 °C)  
 1 kA  
 - / 5 kA  
 10 kA  
 -  
 ≤ 1 kV (C3 - 7.5 kV / 100 A, spike)  
 - / > 100 MHz  
 -

9.5 mm / 21 mm / 53.5 mm  
 -40 °C ... 85 °C  
 IEC 61643-21

### Ordering data

Type	Order No.	Pcs./Pkt.
CTM 2X1-180DC-GS	2838636	10

### Accessories

CTM 10-MAG	2838610	5
CTM EST	2838649	10

ERIC

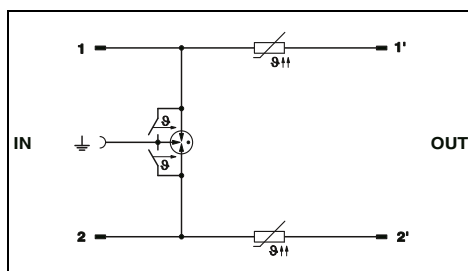

### Technical data

A2 / B1 / B2 / B3 / C1 / C2 / C3 / D1 / D2  
 ± 180 V DC  
 120 mA (25 °C)  
 1 kA  
 - / 5 kA  
 10 kA  
 -  
 ≤ 1 kV (C3 - 7.5 kV / 100 A, spike)  
 - / > 100 MHz  
 5.5 Ω

9.5 mm / 21 mm / 53.5 mm  
 -40 °C ... 85 °C  
 IEC 61643-21

### Ordering data

Type	Order No.	Pcs./Pkt.
CTM 2X1-180DC-GS-P	2838623	10

### Accessories

CTM 10-MAG	2838610	5
CTM EST	2838649	10

# Surge protection and interference suppression filters

## Surge protection for information technology and telecommunications

### LSA-PLUS coarse protection magazine

- For use in CT-TERMIBLOCK or in LSA-PLUS and LSA-PROFIL disconnect and terminal strips

#### CT 10-2/2-GS

- For fitting with 20 two-electrode arresters filled with inert gas
- Common mode voltage coarse protection for 20 signal wires

#### CT ...-2/2-GS/3E

- Fitted with up to 10 three-electrode arresters filled with inert gas
- When the gas-filled surge arrester is triggered, the potentials of the three connections a-b- $\perp$  are equalized
- Coarse protection both in the normal mode voltage branch and the common mode voltage branch for 10 double wires

#### Notes:

For dimensional drawings, see phoenixcontact.net/products



For 10 double wires (loops) and 20 two-electrode GDTs

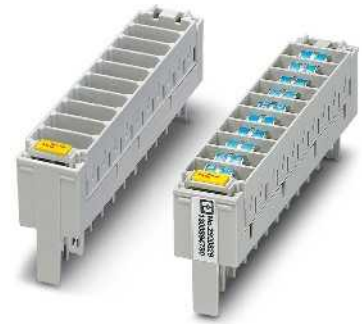

For 10 double wires (loops) and 10 three-electrode GDTs

ERC

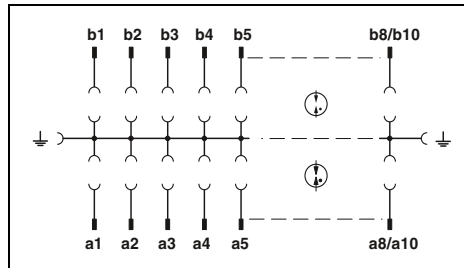

ERC

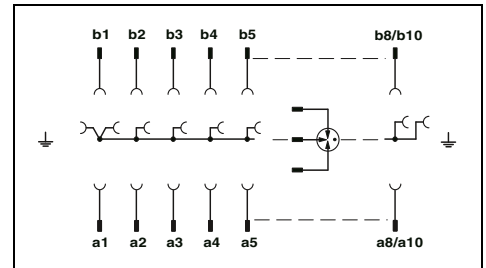

#### Ordering data

Type	Order No.	Pcs./Pkt.
CT 10-2/2-GS	2765398	5

#### Ordering data

Type	Order No.	Pcs./Pkt.
CT 10-2/2-GS/3E	2765408	5
CT 10-2/2-GS/3E-110AC	2920829	10

#### Accessories

Type	Order No.	Pcs./Pkt.
SVP 2E- 48AC	2788919	10
SVP 2E-110AC	2765534	10

#### Accessories

Type	Order No.	Pcs./Pkt.
SVP 3E-110AC	2765521	10

Description	Voltage $U_N$
Coarse protection magazine, to accommodate 20 two-electrode gas-filled surge arresters, type H, unassembled, design: 10 double wires	
Coarse protection magazine, for 10 double wires unassembled, for accommodating 10 three-electrode gas-filled surge arresters	
assembled, with 10 three-electrode gas-filled surge arresters	110 V AC
2-electrode gas-filled surge arrester filled with inert gas, type H, for use in CT 10-2/2-GS coarse protection magazine	48 V AC 110 V AC
3-electrode gas-filled surge arrester filled with inert gas, for use in CT 10-2/2-GS/3E coarse protection magazine	110 V AC

**CT-TERMIBLOCK**

- Screw terminal block
- For COMTRAB protective plugs
- Automatically closing feed-through/disconnect contacts
- Ground terminal blocks on both sides with plug-in connection for the protective plugs used
- Mounting on DIN rails according to EN 60715



**Notes:**  
 For dimensional drawings, see [phoenixcontact.net/products](http://phoenixcontact.net/products)

**For accommodating the CT and CTM protective plugs, with screw connection**

**Magazine for 10 CTM**

General data	
Dimensions W/H/D	
Connection data solid/stranded/AWG	
Temperature range	
Degree of protection in acc. with IEC 60529/EN 60529	
Inflammability class in acc. with UL 94	

Technical data		
Dimensions W/H/D	118 mm / 43 mm / 40.9 mm	
Connection data solid/stranded/AWG	0.2...2.5 mm <sup>2</sup> / 0.2...2.5 mm <sup>2</sup> / 24 ... 12	
Temperature range	-40 °C ... 85 °C	
Degree of protection	IP20	
Inflammability class	V2	

Technical data		
Dimensions W/H/D	112.5 mm / 21.8 mm / 44 mm	
Connection data solid/stranded/AWG	- mm <sup>2</sup> / - mm <sup>2</sup> / -	
Temperature range	-25 °C ... 75 °C	
Degree of protection	IP20	
Inflammability class	V-0	

Description	
<b>Screw terminal block</b> , with disconnect contacts for accommodating the CT and CTM protective plugs, design: 10 double wires	
<b>Magazine</b> , with grounding rail for accommodating up to 10 LSA-PLUS protective plugs (CTM...), for insertion in CT-TERMIBLOCK or LSA-PLUS disconnect strip	

Ordering data		
Type	Order No.	Pcs./Pkt.
CT-TERMIBLOCK 10 DA	0441711	10

Ordering data		
Type	Order No.	Pcs./Pkt.
CTM 10-MAG	2838610	5

**COMTRAB disconnect strip**

- LSA-PLUS disconnect strip
- For COMTRAB protective plugs
- For up to 10 CTM connectors

**Notes:**  
 For dimensional drawings, see [phoenixcontact.net/products](http://phoenixcontact.net/products)

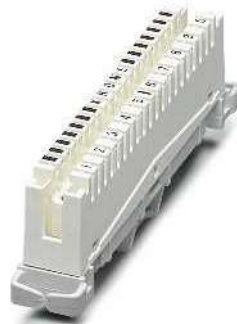

**For accommodating the CT and CTM protective plugs, with LSA-PLUS connection**

**Grounding rail/mounting clip**

Description	
<b>LSA-PLUS disconnect strip</b> for accommodating the CTM and CT 10 protection modules, design: 10 double wires	
<b>Grounding rail</b> for CTM protective plug when used in combination with LSA-PLUS disconnect strip, design: 10 double wires	
<b>Mounting clip</b> , for holding 3 disconnect or ground wire strips, design: 10 double wires	
<b>Mounting clip</b> , for holding 10 disconnect or ground wire strips, design: 10 double wires	
<b>Cable feed-through sleeve</b> for mounting trays, for protecting the lines guided through the laminated frame	

Ordering data		
Type	Order No.	Pcs./Pkt.
CT 10-TL	2765356	5

Ordering data		
Type	Order No.	Pcs./Pkt.
CT 1-10-ES	2765547	10
CT 10-MB/ 3	2765372	2
CT 10-MB/10	2765385	2
CT-KDT	2765518	10



#### **You won't lose reception with COAXTRAB**

Transceiver systems are generally considered to be particularly susceptible to surge voltages. Antenna cables which extend beyond a building and are usually very long, plus the antennas themselves, are directly exposed to atmospheric discharge.

Cables with a coaxial structure and therefore favorable EMC properties are primarily used in antenna systems. However, the risk of surge voltage coupling in antenna cables and potential transfer through to the sensitive interfaces of transceiver systems is not eliminated.

Thanks to interface-optimized surge protective devices, the COAXTRAB product range significantly increases safety for transceiver equipment. The aim of such safety measures is to increase the availability and operability of the devices affected.

**i** Your web code: **#0146**



### Shielding

Good shielding properties are vital for clean transmission. The robust metal housings provide ideal shielding properties and are also suitable for use in harsh industrial environments.

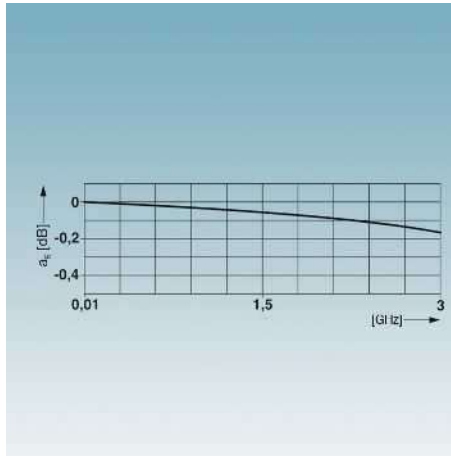

### Customized products

Appropriate protective devices are available for all applications including SAT receiver systems, mobile phones, and video monitoring.

The very low attenuation values ensure that data transmission is clean.



### Performance classes

The protective devices conform to standards in all performance classes. This applies for coarse protection in accordance with Category D1, 10/350  $\mu$ s, and for fine protection in accordance with Category C2 and C1, 8/20  $\mu$ s.



### Connection technology

The right connection technology to suit the application: F connector, TV connector, type N, 7/16, BNC, SMA.

# Surge protection and interference suppression filters

## Surge protection for transceiver systems



The interface matrix indicates which surge protective device is suitable for a specific interface.











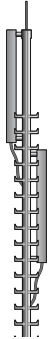

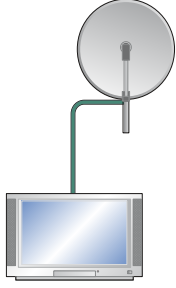

**Note:**

For further interface recommendations, visit [phoenixcontact.net/products](http://phoenixcontact.net/products).

1) The PT-IQ-PTB-UT supply module is required in order to operate the PT-IQ series.

Explanation of the IEC categories		
LPZ zone	Test category for SPD corresponds to IEC 61643-21	Test class for SPD corresponds to IEC 61643-11
0/1	D1	I
1/2	C2	II
2/3	C1	III

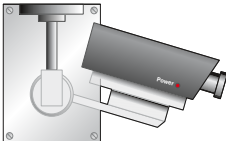
	Screw connection
	Schuko plug-in connection
	Coaxial plug-in connection

Technology	Interface	Connection technology	
		Icon	Type
	GPS, GSM, UMTS, LTE (900, 1800, 1900 MHz)		Type N
	GSM, UMTS, LTE (without COAX DC supply) (900, 1800, 1900 MHz)		Type N
	WiMAX, LTE (2.4 to 6 GHz)		Type N
	GSM, Industrial Wireless (2.4 GHz)		Type SMA
	Satellite television (upstream of the antenna distributor)		Type F
	Satellite television (upstream of the SAT receiver or TV)		Type F
		 	Type F + IEC
	Cable/terrestrial TV		Type IEC
 		Type F + IEC	
	Video monitoring (coax connection)		Type BNC
	Video monitoring (2-wire connection)		

IEC category	Protected wires	Surge protective device (SPD)	Order No.	Page
D1/C2/C3	2	CN-UB-280DC-3	<a href="#">2801050 / 2801051</a>	176
D1/C2/C3	2	CN-UB-70-6	<a href="#">2803166 / 2803153</a>	176
D1/C2/C3	2	CN-LAMBDA/4-2.25	<a href="#">2801057 / 2801056</a>	178
D1/C2/C3	2	CN-LAMBDA/4-5.9	<a href="#">2838490 / 2800023</a>	178
D1/C2/C3	2	CSMA-LAMBDA/4-2.0-BS-SET	<a href="#">2800491</a>	178
D1/C2/C1	5 x 2	C-SAT-BOX	<a href="#">2880561</a>	180
D1/C2/C1	2	C-TV-SAT	<a href="#">2856993</a>	180
D1/C2/C3 & T3	2	MNT-TV-SAT	<a href="#">2882297</a>	74
D1/C2/C1	2	C-TV/HIFI	<a href="#">2857002</a>	180
D1/C2/C3 & T3	2	MNT-TV-SAT	<a href="#">2882297</a>	74
D1/C2/C3	2	C-UFB-5DC/E	<a href="#">2782300</a>	176
D1/C2/C3	2	C-UFB-5DC/E 75	<a href="#">2763604</a>	176
D1/C2/C1	2	PT-IQ-3-PB+F-UT <sup>1</sup> )	<a href="#">2800994</a>	96

# Surge protection and interference suppression filters

## Surge protection for transceiver systems

### Protection of video signals

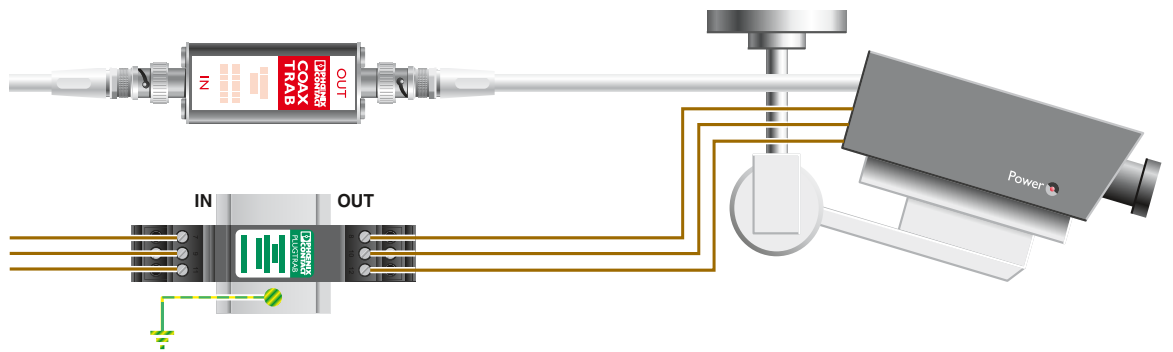
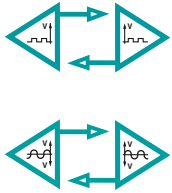

**C-UFB 5DC**  
2797858  
Page 177

**PT 3-HF-12DC-ST + PT 1X2-BE**  
2858043 + 2856113  
Page 144

### Protection of the SAT antenna connection

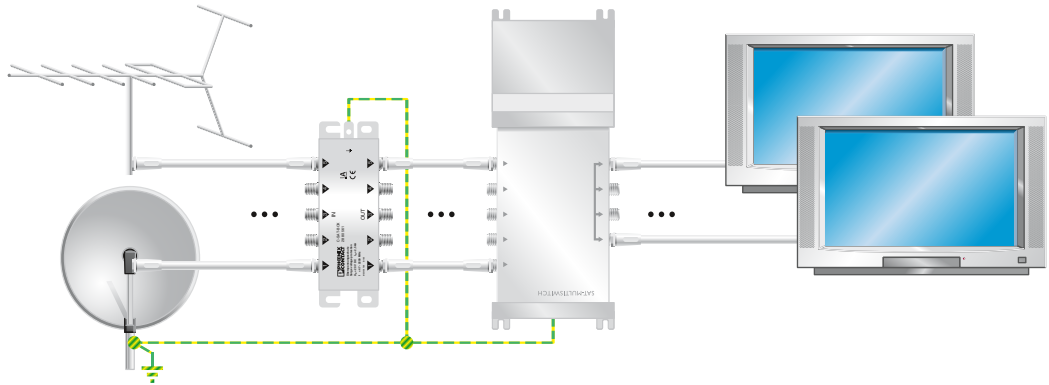
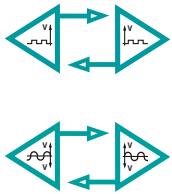

**C-SAT-BOX**  
2880561  
Page 180

### Protection of the cable TV connection

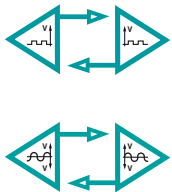

**MNT-TV-SAT D**  
2882284  
Page 75

### Protection of antenna signals

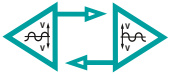
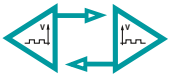

- GPS
- GSM
- UMTS

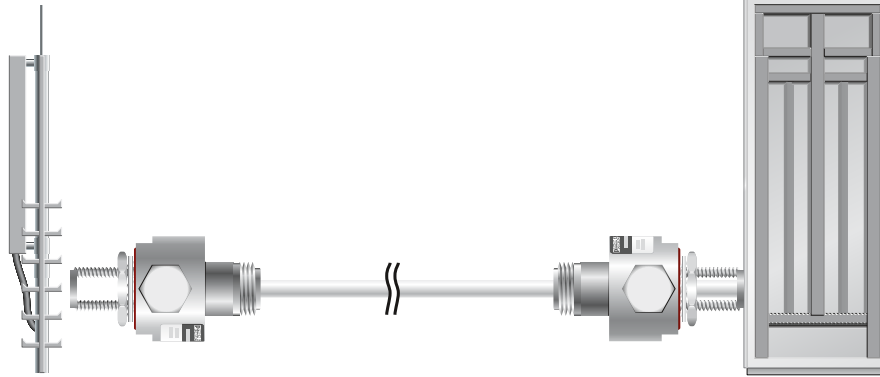

**CN-UB-280DC-3-BB**  
**2801050**  
Page 176

Optional

**CN-LAMBDA/4-2.25-BB**  
**2801057**  
Page 178

# Surge protection and interference suppression filters

## Surge protection for transceiver systems

### Antenna systems

- For antennas with N and BNC connection
- High transmission capacities even for frequencies up to 6 GHz
- Mounting plate enables fixed mounting, e.g., in a control cabinet
- The protective adapters can also be used in a 75 Ω system with 50 Ω BNC connectors
- For the CN-UB-280DC, the gas-filled surge arrester can be replaced in case of malfunction



For GSM systems (0-3 GHz), grounded shield, connection: type N



For GSM systems (0 - 6 GHz), grounded shield, connection: type N

**Notes:**  
Attenuation characteristics at phoenixcontact.net/products

ERC

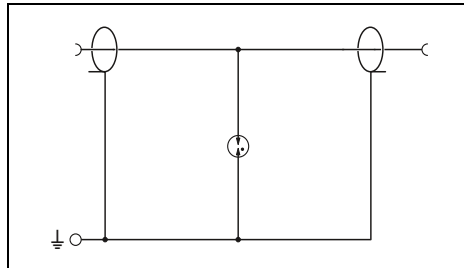

#### Technical data

<b>Electrical data</b>	
IEC test classification/EN type	
Maximum continuous operating voltage $U_C$	
Rated current	
Nominal discharge current $I_n$ (8/20) $\mu$ s	
Total discharge current $I_{total}$ (8/20) $\mu$ s	
Protection level $U_p$	
In a 50 $\Omega$ system	
Standing wave ratio SWR in a 50 $\Omega$ system	
Permissible RF power $P_{max}$	
<b>General data</b>	
Dimensions W/H/D	
Temperature range	
Degree of protection in acc. with IEC 60529/EN 60529	
Connection method	
Test standards	

C2 / C3 / D1	280 V DC
5 A (25 °C)	
Core-Shield / Core-Ground	20 kA / 20 kA
	20 kA
Core-Shield / Core-Ground	$\leq 900$ V (C1 - 1 kV/500 A) / $\leq 900$ V (C1 - 1 kV/500 A)

ERC

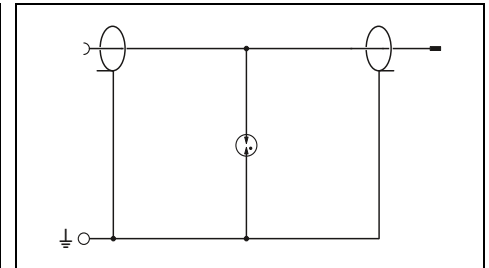

#### Technical data

C2 / C3 / D1	70 V DC / 50 V AC
10 A	
5 kA / 5 kA	
5 kA	
	$\leq 800$ V (C2 - 4 kV/2 kA) / $\leq 800$ V (C2 - 4 kV/2 kA)

> 6 GHz	
typ. 1.15 ( $\leq 6$ GHz)	
30 W (VSWR = 1.15)	
24 mm / 50 mm / 24 mm	
-40 °C ... 90 °C	
IP68	
N connector 50 $\Omega$	
IEC 61643-21	

#### Ordering data

<b>Description</b>
<b>COAXTRAB</b> , protective adapter for antenna connections
Socket-socket
Connector-socket
<b>COAXTRAB</b> , as surge protection for coaxial cables, connection via connector and socket
BNC 50 $\Omega$
BNC 75 $\Omega$
BNC 50 $\Omega$

Type	Order No.	Pcs./Pkt.
CN-UB-280DC-3-BB	2801050	1
CN-UB-280DC-3-SB	2801051	1

#### Ordering data

Type	Order No.	Pcs./Pkt.
CN-UB-70DC-6-BB	2803166	1
CN-UB-70DC-6-SB	2803153	1

#### Accessories

<b>Mounting plate</b> , for individual attachment to housing panels
straight
angled
<b>BNC connector</b> , single-level, for mounting on NS 32 or NS 35/7.5
50 $\Omega$ wave impedance
75 $\Omega$ wave impedance
<b>Adapter</b> , insertion loss <0.3 dB at 2.4 GHz
N (male) -> SMA (female)
<b>Adapter cable</b> , pigtail, 50 $\Omega$ impedance;
50 cm long, MCX (male) -> N (male)

Type	Order No.	Pcs./Pkt.
CN-UB/MP	2818135	10
CN-UB/MP-90DEG-50	2803137	10

#### Accessories

Type	Order No.	Pcs./Pkt.
CN-UB/MP	2818135	10
CN-UB/MP-90DEG-50	2803137	10
<b>RAD-ADP-N/M-SMA/F</b>	2917036	1
<b>RAD-PIG-EF316-MCX-N</b>	2867681	1



For TETRA systems (380 MHz - 470 MHz), floating shield, connection: type N



For video systems, floating shield, coarse protection, connection: BNC



For video systems, floating shield, connection: BNC

ERC

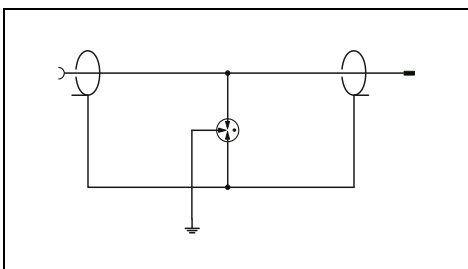

### Technical data

C2 / C3 / D1  
180 V DC / 130 V AC  
5 A (25 °C)

5 kA / 5 kA  
10 kA

≤ 700 V (C2 - 10 kV / 5 kA) /  
≤ 500 V (C2 - 10 kV / 5 kA)

typ. 1 GHz  
typ. 1.2 (≤ 200 MHz)  
300 W (VSWR = 1.1)

25.4 mm / 96 mm / 25.4 mm  
-40 °C ... 80 °C  
-  
N connector 50 Ω  
IEC 61643-21 / -

### Ordering data

Type	Order No.	Pcs./Pkt.
CN-UB/E-BB	2817686	1
CN-UB/E	2763691	1

### Accessories

Accessories	Order No.	Pcs./Pkt.
BNC-V 50	2805041	10

ERC

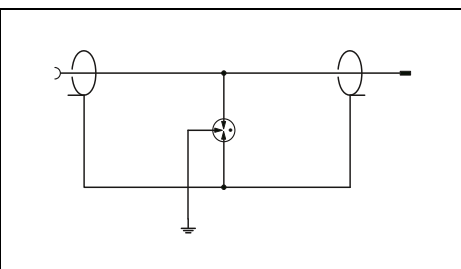

### Technical data

C2 / C3 / D1  
180 V DC / 130 V AC  
3.5 A (25 °C)

5 kA / 5 kA  
10 kA

≤ 700 V (C2 - 10 kV / 5 kA) /  
≤ 500 V (C2 - 10 kV / 5 kA)

typ. 1 GHz  
typ. 1.3 (≤ 150 MHz)  
300 W (VSWR = 1.1)

25.4 mm / 80 mm / 25.4 mm  
-40 °C ... 80 °C  
-  
BNC 50 Ω  
IEC 61643-21 / -

### Ordering data

Type	Order No.	Pcs./Pkt.
C-UB/E	2763701	10

### Accessories

Accessories	Order No.	Pcs./Pkt.
BNC-V 50	2805041	10

ERC

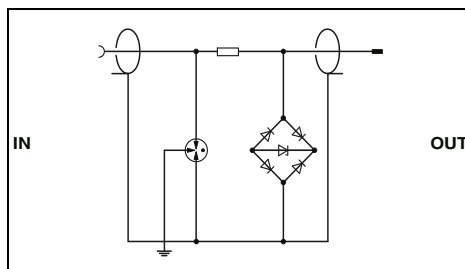

### Technical data

... 5DC/E	... 24DC/E	... 5DC/E 75
C2 / C3 / D1	C2 / C3 / D1	C2 / C3 / D1
5 V DC	30 V DC	-
185 mA (25 °C)	185 mA (25 °C)	185 mA (25 °C)
10 kA / 10 kA	10 kA / 10 kA	10 kA / 10 kA
20 kA	20 kA	20 kA
≤ 25 V (C3 - 10 A) / ≤ 500 V (C3 - 10 A)	≤ 50 V (C3 - 10 A) / ≤ 500 V (C3 - 10 A)	≤ 25 V (C3 - 10 A) / ≤ 500 V (C3 - 10 A)
typ. 90 MHz	typ. 90 MHz	typ. 80 MHz
-	-	-

25.4 mm / - / 93 mm  
-40 °C ... 80 °C  
-  
BNC 50 Ω    BNC 50 Ω    BNC 75 Ω  
IEC 61643-21

### Ordering data

Type	Order No.	Pcs./Pkt.
C-UBF- 5DC/E	2782300	10
C-UBF- 5DC/E 75	2763604	10
C-UBF-24DC/E	2782313	10

### Accessories

Accessories	Order No.	Pcs./Pkt.
BNC-V 50	2805041	10
BNC-V 75	2805070	10

# Surge protection and interference suppression filters

## Surge protection for transceiver systems

### Antenna systems

- For antennas with N and SMA connection
- High transmission capacities even for frequencies up to 6 GHz
- Maintenance-free surge protection with Lambda/4 technology
- Low protection level

**Notes:**  
Attenuation characteristics at phoenixcontact.net/products



For TETRA systems (380 MHz - 470 MHz), grounded shield, connection: type N



For GSM systems (0.8 GHz-2.25 GHz), grounded shield, connection: type N

ERC

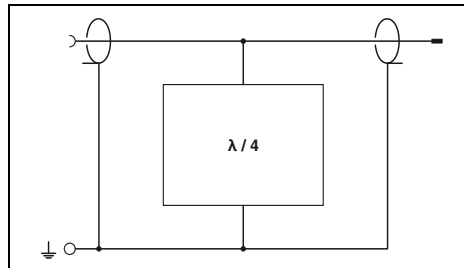

ERC

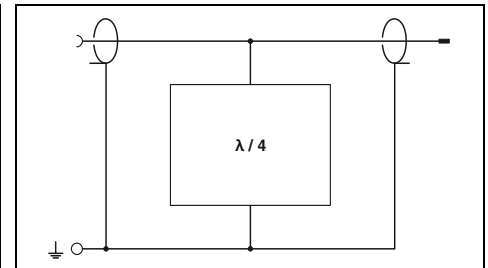

#### Technical data

Electrical data	
IEC test classification/EN type	C2 / C3 / D1
Rated current	5 A (25 °C)
Nominal discharge current $I_n$ (8/20) $\mu$ s	Core-Shield / Core-Ground 20 kA / 20 kA
Total discharge current $I_{total}$ (8/20) $\mu$ s	30 kA
Protection level $U_p$	Core-Shield / Core-Ground $\leq 95$ V (C2 - 10 kV / 5 kA) / $\leq 95$ V (C2 - 10 kV / 5 kA)
Frequency range	380 MHz ... 470 MHz
Standing wave ratio SWR in a 50 $\Omega$ system	typ. 1.05 ( $\leq 1.15$ )
Permissible RF power $P_{max}$	$\leq 800$ W
General data	
Dimensions W/H/D	32 mm / 32 mm / 83 mm
Temperature range	-40 °C ... 90 °C
Degree of protection in acc. with IEC 60529/EN 60529	IP68
Connection method	N Connector
Test standards	IEC 61643-21

Technical data	
IEC test classification/EN type	C2 / C3 / D1
Rated current	-
Nominal discharge current $I_n$ (8/20) $\mu$ s	Core-Shield / Core-Ground 50 kA / 50 kA
Total discharge current $I_{total}$ (8/20) $\mu$ s	-
Protection level $U_p$	- / $\leq 5$ V (C1 - 1 kV/500 A)
Frequency range	0.8 GHz ... 2.25 GHz
Standing wave ratio SWR in a 50 $\Omega$ system	typ. 1.2
Permissible RF power $P_{max}$	$\leq 500$ W
General data	
Dimensions W/H/D	25 mm / 77.5 mm
Temperature range	-40 °C ... 85 °C
Degree of protection in acc. with IEC 60529/EN 60529	IP68
Connection method	N connector 50 $\Omega$
Test standards	IEC 61643-21/A1 / EN 61643-21/A1

#### Ordering data

Description	
COAXTRAB, protective adapter for antenna connections with Lambda/4 technology	
Socket-socket	CN-LAMBDA/4-0.47-BB
Connector-socket	CN-LAMBDA/4-0.47-SB
Surge protection for UMTS and quad-band GSM antenna, with SMA plug and SMA coupling	

Type	Order No.	Pcs./Pkt.
CN-LAMBDA/4-0.47-BB	2800021	1
CN-LAMBDA/4-0.47-SB	2800022	1

#### Ordering data

Type	Order No.	Pcs./Pkt.
CN-LAMBDA/4-2.25-BB	2801057	1
CN-LAMBDA/4-2.25-SB	2801056	1

#### Accessories

Mounting plate, for individual attachment to housing panels	
straight	CN-UB/MP-90DEG-50
angled	
Adapter, insertion loss <0.3 dB at 2.4 GHz	
N (male) -> SMA (female)	RAD-ADP-N/M-SMA/F
Adapter cable, pigtail, 50 $\Omega$ impedance;	
50 cm long, MCX (male) -> N (male)	RAD-PIG-EF316-MCX-N
30 cm long, N (female) -> SMA (male)	RAD-PIG-EF316-N-SMA

Type	Order No.	Pcs./Pkt.
CN-UB/MP-90DEG-50	2803137	10
RAD-ADP-N/M-SMA/F	2917036	1
RAD-PIG-EF316-MCX-N	2867681	1
RAD-PIG-EF316-N-SMA	2867694	1

#### Accessories

Type	Order No.	Pcs./Pkt.
CN-UB/MP-90DEG-50	2803137	10
RAD-ADP-N/M-SMA/F	2917036	1
RAD-PIG-EF316-MCX-N	2867681	1
RAD-PIG-EF316-N-SMA	2867694	1



For GSM systems (0.8 GHz - 2.25 GHz), grounded shield, connection: SMA



For GSM and WiMAX systems (2.4 GHz - 5.9 GHz), grounded shield, connection: type N

ERC

ERC

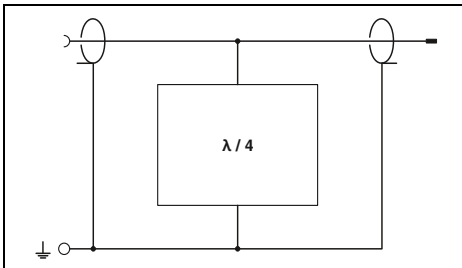
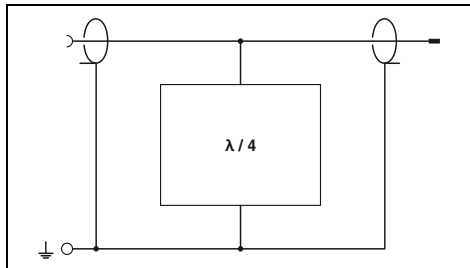

### Technical data

C2 / C3 / D1  
2 A (25 °C)

6 kA / 6 kA  
6 kA

- / ≤ 5 V (C1 - 1 kV/500 A)  
0.8 GHz ... 2.25 GHz  
≤ 1.2 (0.8 GHz ... 2.25 GHz)  
≤ 110 W (VSWR = 1.0)

46.5 mm / 25 mm / 70 mm  
-40 °C ... 70 °C  
IP55  
SMA connector  
IEC 61643-21/A1 / EN 61643-21/A1

### Technical data

C2 / C3 / D1  
5 A (25 °C)

50 kA / 50 kA  
60 kA

- / ≤ 11 V (6 kV / 3 kA)  
2.4 GHz ... 5.9 GHz  
typ. 1.1 (≤ 1.20 (2.4 GHz...5.9 GHz))  
≤ 500 W

26.1 mm / 38 mm / 60 mm  
-40 °C ... 90 °C  
IP68  
N Connector  
IEC 61643-21

### Ordering data

Type	Order No.	Pcs./Pkt.
CSMA-LAMBDA/4-2.0-BS-SET	2800491	1

### Ordering data

Type	Order No.	Pcs./Pkt.
CN-LAMBDA/4-5.9-BB	2838490	1
CN-LAMBDA/4-5.9-SB	2800023	1

### Accessories

CN-UB/MP	2818135	10
CN-UB/MP-90DEG-50	2803137	10

### Accessories

CN-UB/MP-90DEG-50	2803137	10
RAD-ADP-N/M-SMA/F	2917036	1
RAD-PIG-EF316-MCX-N	2867681	1

# Surge protection and interference suppression filters

## Surge protection for transceiver systems

### TV and radio systems

#### C-SAT-BOX

- Protection for antenna inputs in satellite receiver technology
- Used upstream of antenna distributor or multi-switch
- Analog and digital SAT signals
- Terrestrial antenna signals
- Direct wall mounting supported

#### C-TV-SAT and C-TV/HIFI

- Protective adapter for antenna connections
- Use on broadband cable or SAT connection
- TV (IEC) or F connector

**Notes:**  
Attenuation characteristics at [phoenixcontact.net/products](http://phoenixcontact.net/products)



For antenna distributor or multi-switch, grounded shield, connection: F

ERC

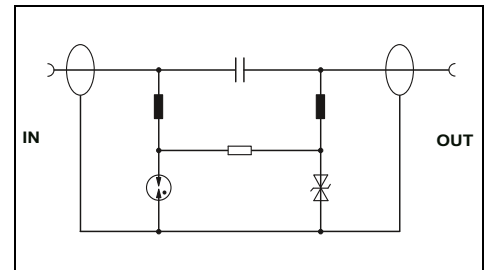

#### Technical data

Electrical data	
IEC test classification/EN type	B2 / C1 / C2 / C3 / D1
Maximum continuous operating voltage $U_c$	20 V DC / -
Rated current	400 mA (25 °C)
Nominal discharge current $I_n$ (8/20) $\mu$ s	
	Core-Shield / Core-Ground
Total discharge current $I_{total}$ (8/20) $\mu$ s	2.5 kA / 2.5 kA
Output voltage limitation at 1 kV/ $\mu$ s	10 kA
	Core-Shield / Core-Ground
Output voltage limitation at 1 kV/ $\mu$ s	$\leq 80$ V / $\leq 80$ V
Cut-off frequency fg (3 dB)	
In a 75 $\Omega$ system	Symmetrical / Asymmetrical
	- / > 2.5 GHz
General data	
Dimensions W/H/D	145 mm / 72 mm / 32 mm
Temperature range	-25 °C ... 55 °C
Degree of protection in acc. with IEC 60529/EN 60529	IP40
Inflammability class in acc. with UL 94	-
Connection method	F connector
Test standards	IEC 61643-21+A1+A2 / DIN EN 61643-21 / DIN EN 50083-2

#### Ordering data

Description	Type	Order No.	Pcs./Pkt.
<b>COAXTRAB</b> , protective device for antenna distributors/multi-switches for insertion in the antenna line	C-SAT-BOX	2880561	1
<b>COAXTRAB</b> , surge protection adapter			
	F connector TV connector		

#### Accessories

<b>Adapter</b> , to connect the C-SAT-BOX with antenna distributors with a pitch of 20 mm (e.g. ASTRO, SPAUN)	ADAPTER KOAX TYP F	2880972	5
<b>Connection cable</b> , to connect the C-SAT-BOX with the antenna distributor, length: 0.2 m	KBL-SAT/20	2880985	5



For TV equipment and SAT systems,  
grounded shield, connection: F or TV (IEC)

ERIC

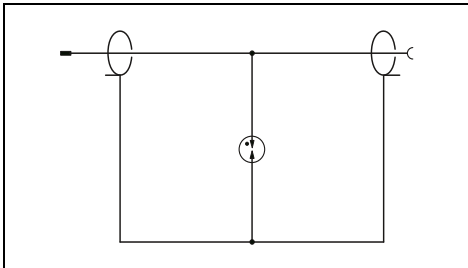

**Technical data**

F-connector	TV connector
C1 / C2 / C3 / D1	C1 / C2 / C3 / D1
24 V DC / -	24 V DC / -
1.5 A (25 °C)	1.5 A (25 °C)
2.5 kA / -	2.5 kA / -
-	-
≤ 600 V / -	≤ 600 V / -
- / > 3 GHz	- / > 1 GHz

28 mm / 66 mm / 44 mm  
-25 °C ... 75 °C

V-0

F connector PAL-TV (IEC 169-2)  
IEC 61643-21 / EN 61643-21 / EN 50083

**Ordering data**

Type	Order No.	Pcs./Pkt.
C-TV-SAT	2856993	1
C-TV/HIFI	2857002	1

**Accessories**

--	--	--



### Reliable signals by means of interference suppression filters with integrated surge protection

Switching operations triggered mechanically or electronically generate pulse-like and high-frequency interference voltages. These voltages spread in an unimpeded manner across the cable network. All the devices within this cable network are affected. Data errors, uncontrolled functions, and system crashes can result, with data processing devices at particular risk.

### Interference voltage filters for power supply units

Interference suppression filters limit conducted high-frequency interference voltages. Devices used in data processing or automation particularly benefit from a clean power supply. The end result is safe operation and reliable measured results. Thanks to the integrated surge protection, surge pulses are effectively limited and surge currents are safely discharged.

 Your web code: [#0149](#)

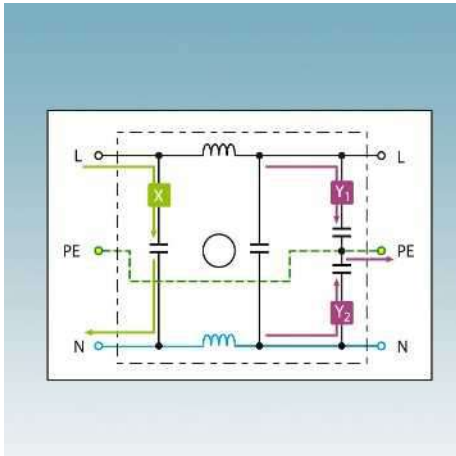

### Mains interference filters - operating principle and range

#### Filtering of symmetrical disturbance variables

**X** - Interference voltages between the phase and neutral conductor are filtered.

#### Filtering of asymmetrical disturbance variables

**Y<sub>1</sub>, Y<sub>2</sub>** - The opposite grounded interference voltages from phase to PE and from the neutral conductor to PE are filtered.

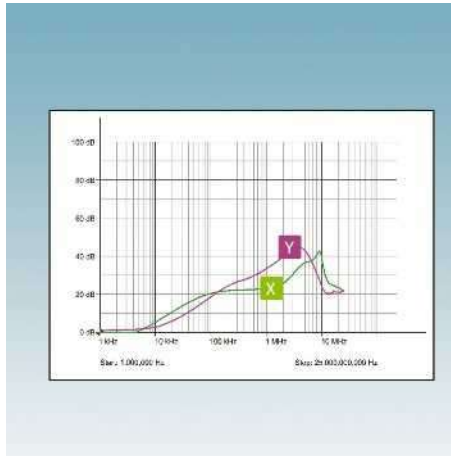

### Operating range of filters

An attenuation curve diagram illustrates the effective operating range of mains interference filters. The relevant frequency-dependent attenuation can be read according to the symmetrical or asymmetrical filter circuit.



### Interference suppression filters with surge protection

Interference suppression filters with integrated surge protection have two tasks: they absorb surge voltages and also limit high-frequency interference voltages.

Versions are available for the power supply and for signal circuits.

# Surge protection and interference suppression filters

## Interference suppression filters

### DIN-rail-mountable device protection with SFP-TRAB interference suppression filter

- Combined protective circuit for absorbing transient surge voltages and high-frequency interference voltages
- Thermal monitoring of the protective circuit
- Disconnection status signaled via floating remote indication contact
- Can be installed in industrial environments



20 A nominal current

Total width 112 mm

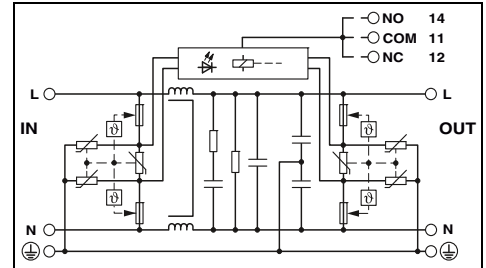

#### Technical data

Electrical data	... 120AC	... 230AC
IEC test classification / EN Type / SPD Type (UL)	III / T3 / 2CA	III / T3 / -
Nominal voltage $U_N$	120 V AC (TN) / 120 V AC (TT - only in use with RCD) / 120 V AC (IT)	240 V AC (TN) / 240 V AC (TT - only in use with RCD) / 240 V AC (IT - only in use with RCD)
Maximum continuous operating voltage $U_C$	150 V AC	264 V AC
Nominal load current $I_L$	20 A (40°C)	20 A (40°C)
Combined surge $U_{OC}$	6 kV (3 kA)	10 kV (5 kA)
Protection level $U_p$	$\leq 0.45$ kV	$\leq 1$ kV
Response time $t_A$	$\leq 25$ ns	$\leq 25$ ns
Backup fuse max. in acc. with IEC	20 A (MCB B/general purpose)	20 A (MCB B/general purpose)
Input attenuation $a_i$		
Inductance	Symmetrical	20 dB ( $\geq 100$ kHz / 50 $\Omega$ )
	Asymmetrical	30 dB ( $\geq 1$ MHz / 50 $\Omega$ )
		2x 1 mH $\pm 30$ % (with current compensation)
General data		
Dimensions W/H/D	112 mm / 93 mm / 79 mm	
Connection data solid/stranded/AWG	2.5 mm <sup>2</sup> ... 6 mm <sup>2</sup> / 2.5 mm <sup>2</sup> ... 4 mm <sup>2</sup> / 14 ... 10	
Temperature range	-25 °C ... 70 °C	
Inflammability class in acc. with UL 94	V-0	
Test standards	IEC 61643-11 / EN 61643-11	
Remote indication contact	PDT contact	
Connection data solid/stranded/AWG	0.14 mm <sup>2</sup> ... 1.5 mm <sup>2</sup> / 0.14 mm <sup>2</sup> ... 1.5 mm <sup>2</sup> / 26 ... 16	
Max. operating voltage	250 V AC / 250 V DC	
Max. operating current	1 A AC / 1 A DC	

#### Ordering data

Description	Voltage $U_N$	Type	Order No.	Pcs./Pkt.
<b>SFP-TRAB</b> , DIN-rail-mountable TVSS device protection with integrated mains interference filter and optical signaling				
Nominal current: 20 A	120 V AC	<b>SFP 1-20/120AC</b>	<b>2856702</b>	1
Nominal current: 20 A	240 V AC	<b>SFP 1-20/230AC</b>	<b>2859987</b>	1
<b>SFP-TRAB</b> , DIN-rail-mountable device protection with integrated mains interference filter and optical signaling				
Nominal current: 5 A	120 V AC			
Nominal current: 10 A	120 V AC			
Nominal current: 15 A	120 V AC			



5 A nominal current



10 A nominal current



15 A nominal current

Total width 112 mm

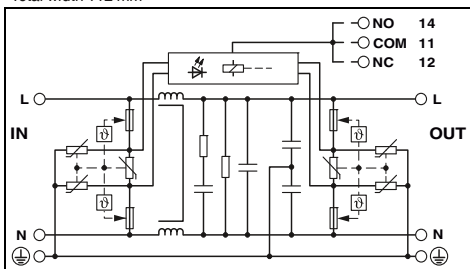

### Technical data

III / T3 / 2CA  
120 V AC (TN) /  
120 V AC (TT - only in use with RCD) /  
120 V AC (IT)

150 V AC  
5 A (70°C)  
6 kV (3 kA)  
≤ 0.45 kV  
≤ 25 ns  
20 A (MCB B/general purpose)

20 dB (≥ 100 kHz / 50 Ω)  
30 dB (≥ 1 MHz / 50 Ω)  
2x 1 mH ±30 % (with current compensation)

112 mm / 93 mm / 79 mm  
2.5 mm<sup>2</sup> ... 6 mm<sup>2</sup> / 2.5 mm<sup>2</sup> ... 4 mm<sup>2</sup> / 14 ... 10

-25 °C ... 70 °C  
V-0  
IEC 61643-11 / EN 61643-11

PDT contact  
0.14 mm<sup>2</sup> ... 1.5 mm<sup>2</sup> / 0.14 mm<sup>2</sup> ... 1.5 mm<sup>2</sup> / 26 ... 16

250 V AC / 250 V DC  
1 A AC / 1 A DC

### Ordering data

Type	Order No.	Pcs./Pkt.
SFP 1-5/120AC	2920667	1

Total width 112 mm

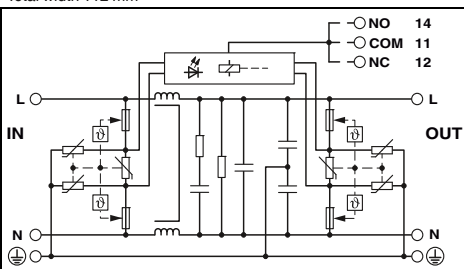

### Technical data

III / T3 / 2CA  
120 V AC (TN) /  
120 V AC (TT - only in use with RCD) /  
120 V AC (IT)

150 V AC  
10 A (60°C)  
6 kV (3 kA)  
≤ 0.45 kV  
≤ 25 ns  
20 A (MCB B/general purpose)

20 dB (≥ 100 kHz / 50 Ω)  
30 dB (≥ 1 MHz / 50 Ω)  
2x 1 mH ±30 % (with current compensation)

112 mm / 93 mm / 79 mm  
2.5 mm<sup>2</sup> ... 6 mm<sup>2</sup> / 2.5 mm<sup>2</sup> ... 4 mm<sup>2</sup> / 14 ... 10

-25 °C ... 70 °C  
V-0  
IEC 61643-11 / EN 61643-11

PDT contact  
0.14 mm<sup>2</sup> ... 1.5 mm<sup>2</sup> / 0.14 mm<sup>2</sup> ... 1.5 mm<sup>2</sup> / 26 ... 16

250 V AC / 250 V DC  
1 A AC / 1 A DC

### Ordering data

Type	Order No.	Pcs./Pkt.
SFP 1-10/120AC	2920670	1

Total width 112 mm

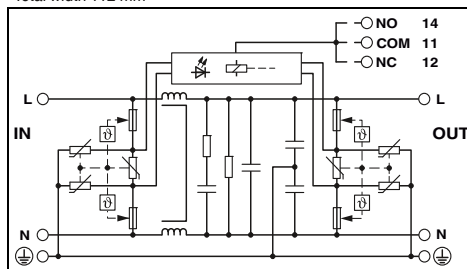

### Technical data

III / T3 / 2CA  
120 V AC (TN) /  
120 V AC (TT - only in use with RCD) /  
120 V AC (IT)

150 V AC  
15 A (50°C)  
6 kV (3 kA)  
≤ 0.45 kV  
≤ 25 ns  
20 A (MCB B/general purpose)

20 dB (≥ 100 kHz / 50 Ω)  
30 dB (≥ 1 MHz / 50 Ω)  
2x 1 mH ±30 % (with current compensation)

112 mm / 93 mm / 79 mm  
2.5 mm<sup>2</sup> ... 6 mm<sup>2</sup> / 2.5 mm<sup>2</sup> ... 4 mm<sup>2</sup> / 14 ... 10

-25 °C ... 70 °C  
V-0  
IEC 61643-11 / EN 61643-11

PDT contact  
0.14 mm<sup>2</sup> ... 1.5 mm<sup>2</sup> / 0.14 mm<sup>2</sup> ... 1.5 mm<sup>2</sup> / 26 ... 16

250 V AC / 250 V DC  
1 A AC / 1 A DC

### Ordering data

Type	Order No.	Pcs./Pkt.
SFP 1-15/120AC	2920683	1

# Surge protection and interference suppression filters

## Interference suppression filters

### TERMITRAB

**Notes:**  
Attenuation characteristics at [phoenixcontact.net/products](http://phoenixcontact.net/products)

- Combined protective circuit for absorbing transient surge voltages and high-frequency interference voltages
- With spring-cage connection
- Disconnection of signal circuits by disconnect knife



Protection for two conductors with a common reference potential

ERIC

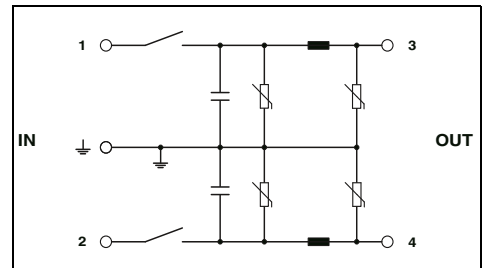

Electrical data	
IEC test classification/EN type	C1 / C3
Maximum continuous operating voltage $U_c$	38 V DC / 30 V AC
Rated current	500 mA (55°C)
Nominal discharge current $I_n$ (8/20) $\mu$ s	
Total discharge current $I_{total}$ (8/20) $\mu$ s	Core-Ground 350 A (per path) 700 A
Output voltage limitation at 1 kV/ $\mu$ s	Core-Ground $\leq 70$ V (per path)
Cut-off frequency $f_g$ (3 dB)	Asymmetrical in the 50 $\Omega$ system
Resistance per path	typ. 60 kHz
Inductance per path	0.5 $\Omega$
Capacity per path	typ. 100 $\mu$ H typ. 130 nF
General data	
Connection data solid/stranded/AWG	0.2 mm <sup>2</sup> ... 4 mm <sup>2</sup> / 0.2 mm <sup>2</sup> ... 2.5 mm <sup>2</sup> / 24 ... 12
Temperature range	-40 °C ... 85 °C
Degree of protection in acc. with IEC 60529/EN 60529	IP20
Inflammability class in acc. with UL 94	V-0
Test standards	IEC 61643-21 / EN 61643-21

### Technical data

Ordering data		
Type	Order No.	Pcs./Pkt.
TT-ST-M-SFP-24AC	2858946	10
Accessories		
TT-D-STTCO-BK	2858894	50

Description	Voltage $U_N$
TERMITRAB, spring-cage terminal block with integrated surge protection as a filter circuit and disconnect knives, for mounting on NS 35	24 V AC
Cover, for terminating a row of terminal blocks	

**FILTRAB**

- Low pass filters for nominal currents of 1 to 10 A
- For single-phase circuits
- DIN rail module

**Notes:**  
Attenuation characteristics at phoenixcontact.net/products

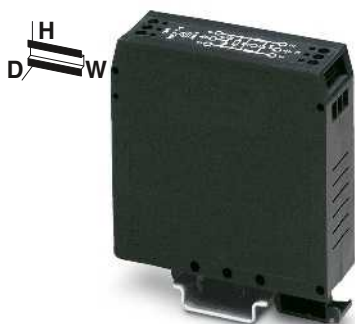

1 A / 3 A nominal current

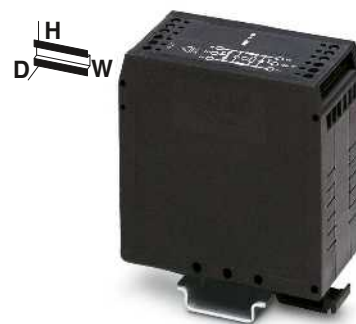

6 A / 10 A nominal current

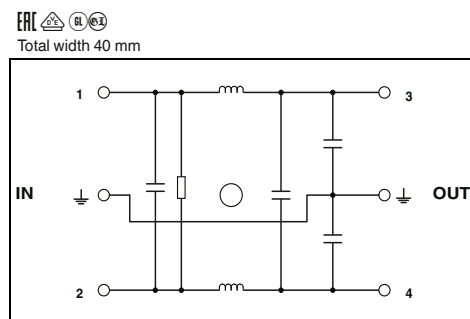
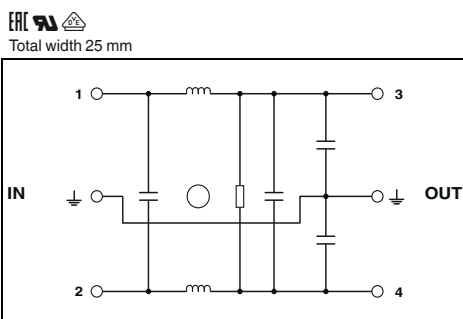

Electrical data	
Rated voltage	240 V AC (L-N) 264 V AC (L-N) / 264 V AC (L-PE)
Maximum continuous operating voltage $U_c$	
Rated current	1 A (40°C) 3 A (40°C)
Backup fuse max. in acc. with IEC	1 A (gL) 3 A (gL)
Inductance	2x 10 mH 2x 2.7 mH
Input attenuation $a_i$	Symmetrical > 65 dB (50 Ω/ 1 MHz) Asymmetrical > 45 dB (50 Ω/ 1 MHz)
General data	
Dimensions W/H/D	25 mm / 79.4 mm / 84.15 mm
Connection data solid/stranded/AWG	0.2 ... 4 mm <sup>2</sup> / 0.2 ... 2.5 mm <sup>2</sup> / 24 - 12
Temperature range	-25 °C ... 100 °C (HMF)
Inflammability class in acc. with UL 94	V-2
Test standards	IEC 60939-2 / EN 60939-2

Technical data	
NEF 1- 1	NEF 1- 3
240 V AC (L-N)	240 V AC (L-N)
264 V AC (L-N) / 264 V AC (L-PE)	264 V AC (L-N) / 264 V AC (L-PE)
1 A (40°C)	3 A (40°C)
1 A (gL)	3 A (gL)
2x 10 mH	2x 2.7 mH
Symmetrical > 65 dB (50 Ω/ 1 MHz)	> 55 dB (50 Ω/ 1 MHz)
Asymmetrical > 45 dB (50 Ω/ 1 MHz)	> 35 dB (50 Ω/ 1 MHz)
25 mm / 79.4 mm / 84.15 mm	
0.2 ... 4 mm <sup>2</sup> / 0.2 ... 2.5 mm <sup>2</sup> / 24 - 12	
-25 °C ... 100 °C (HMF)	
V-2	
IEC 60939-2 / EN 60939-2	

Technical data	
NEF 1- 6	NEF 1-10
240 V AC (L-N)	240 V AC (L-N)
264 V AC (L-N) / 264 V AC (L-PE)	264 V AC (L-N) / 264 V AC (L-PE)
6 A (40°C)	10 A (40°C)
6.3 A (gL/C)	10 A (gL)
2x 2.7 mH	2x 1.8 mH
> 80 dB (50 Ω/ 1 MHz)	> 80 dB (50 Ω/ 1 MHz)
> 40 dB (50 Ω/ 1 MHz)	> 40 dB (50 Ω/ 1 MHz)
40 mm / 79.4 mm / 84.1 mm	
0.2 ... 4 mm <sup>2</sup> / 0.2 ... 2.5 mm <sup>2</sup> / 24 - 12	
-25 °C ... 100 °C (HMF)	
V-2	
IEC 60939-2 / EN 60939-2	

Ordering data	
Description	Nominal load current $I_L$
<b>FILTRAB</b> , interference suppression filter for single-phase current circuits, for mounting on NS 32 or NS 35...	
	1 A
	3 A
	6 A
	10 A

Type	Order No.	Pcs./Pkt.
NEF 1- 1	2794123	10
NEF 1- 3	2794110	10

Type	Order No.	Pcs./Pkt.
NEF 1- 6	2783082	5
NEF 1-10	2788977	5



Lightning strikes cause devastating damage to buildings and systems. It is practically impossible for employees to continuously monitor exposed or large-scale systems, which means that damage is detected too late.

### Detecting lightning with the lightning monitoring system

The LM-S lightning monitoring system supports continuous monitoring. Lightning events are detected, evaluated, and remotely monitored via network access. By consolidating the system operating parameters and the measuring data, the system provides a better basis for making decisions regarding control and maintenance.

The LM-S lightning monitoring system consists of the following components:

- Sensor
- Connecting cable
- O/E module
- Evaluation unit

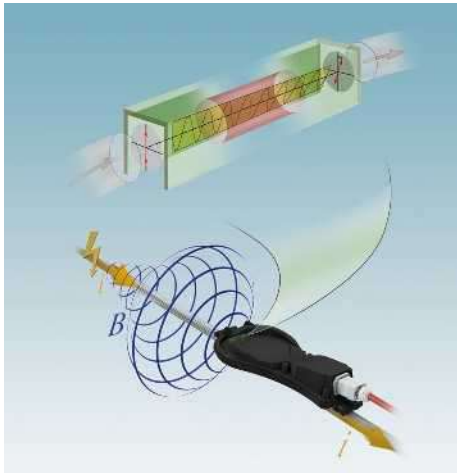

### Faraday effect as a reliable measuring method

The internal measuring principle of the LM-S is based on the Faraday effect. Polarized light in a specific medium is rotated through a magnetic field over a defined length and measured.

The higher the amperage ( $i$ ) generated by a lightning strike the greater the magnetic flux density ( $B$ ) and, therefore, the rotation of the polarized light.

The lightning monitoring system detects this change in the light signal and uses this as the basis for the corresponding measured value results.



### Remote monitoring in real time

The evaluation unit can be easily integrated into standard network systems via the RJ45 Ethernet interface. The data acquired can be accessed and the system can be configured via web interface, Modbus/TCP or OPC UA. The web interface is opened via the Internet browser on a PC connected to the system using IP addressing.

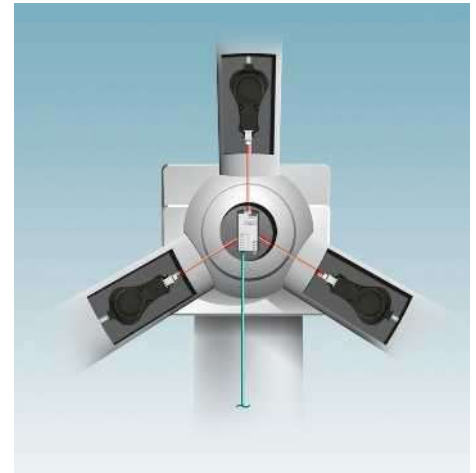

### Detection and evaluation

The sensors are mounted on the lightning arrester cables. They record the magnetic field that occurs around the conductor due to the lightning surge current. The measured result is transmitted via fiber optics to the O/E module of the evaluation unit, where the optical signal is converted into an electrical signal. Based on the values obtained, the evaluation unit determines the lightning characteristics with their typical parameters, including, for example, the maximum lightning current strength, lightning current rate of rise, charge, and energy. These results can be forwarded to an available management system via the Ethernet interface.

# Surge protection and interference suppression filters

## Lightning current measurement

### Sensor

- Optical sensor for measuring lightning surge currents
- Can be retrofitted
- Resistant to humidity
- Good UV resistance



Sensor

Technical data			
Detectable values			
Maximum current strength	400 kA		
FO interface			
Connection method	SC-RJ socket with push-pull connector, IP67		
General data			
Ambient temperature (operation)	-30 °C ... 60 °C		
Ambient temperature (storage/transport)	-40 °C ... 85 °C		
Degree of protection	IP67		
Ordering data			
Description	Type	Order No.	Pcs./Pkt.
Sensor	LM-S-LS-H	2800616	1

### Connecting cable

- HCS cable for connecting LM-S sensors to the O/E module
- Good UV resistance
- Good oil resistance

#### Notes:

The specified connector configuration (see ordering example) must be used in order to use the connecting cable in the LM-S lightning monitoring system.  
Recommended length: 10 to 200 m



Connecting cable for LM-S

### Ordering example for LM-S connecting cable with variable cable length:

Assembled connecting cable for the LM-S lightning monitoring system, with a metal push-pull connector, a B-FOC connector, and a cable length of 10 m.

Ordering data		
Description		
Connecting cable, variable		
Type	Order No.	Pcs./Pkt.
FOC-SJ:14-ST/HB02/...	1417723	1

Order No.	Length [m]
1417723 / FOC-SJ:14-ST/HB02	10.0
	<b>Increments:</b> 10.0 m ... 200 m = 1.0 m

## Evaluation unit

- Complete module including O/E module for connecting up to three LM-S sensors
- Evaluation and storage of amperage, current rate of rise, charge, and specific energy
- Real-time analysis and exact time allocation
- Status and diagnostic indicators
- Communication via Ethernet
- Operation and configuration via web interface, Modbus/TCP, and OPC-UA
- Mounted on DIN rails



Evaluation unit with O/E module

Technical data	
Operating voltage	24 V DC $\pm$ 4 V
Ethernet ports	
Connection method	RJ45
Transmission speed	10/100 Mbps
FO interface	
Interface	B-FOC (ST®)
Number of ports	3
Sensor interfaces	
Connection method	Rack for plug-in I/O module
Remote indication contact	
Connection method	M12 D-coded
Max. operating voltage	60 V DC
General data	
Ambient temperature (operation)	-30 °C ... 60 °C
Degree of protection	IP20

Ordering data			
Description	Type	Order No.	Pcs./Pkt.
Evaluation unit with O/E module	LM-S-A/C-3S-ETH	2800618	1

## Opto-electronic module

- O/E module replacement for evaluation unit
- Connection of up to three LM-S sensors
- Status and diagnostic display via evaluation unit



O/E module

Technical data	
FO interface	
Interface	B-FOC (ST®)
Number of ports	3
General data	
Ambient temperature (operation)	-30 °C ... 60 °C
Ambient temperature (storage/transport)	-40 °C ... 85 °C
Degree of protection	IP20

Ordering data			
Description	Type	Order No.	Pcs./Pkt.
Opto-electronic module	LM-S-C-3LS	2800617	1



### **CHECKMASTER 2 – the intelligent test device for surge protective devices**

Outdoor and indoor lightning protection must be regularly tested in accordance with normative requirements (IEC 62305) and official regulations. A basic visual check is not enough to identify damage to surge protective devices. Only an electrical check using the CHECKMASTER 2 produces meaningful results. The electrical check is performed with the aid of a programmable logic controller, a high-voltage source, and a constant current source. During the check, a program-controlled electrical test is performed on all the relevant components of the surge protective device. Thanks to the integrated database for surge protective devices, spark gaps, gas-filled surge protective devices, varistors, and suppressor diodes can be checked automatically. Surge protective devices that were previously damaged, surge protective devices that are nearing the electrical tolerance limits, and faulty surge protective devices can be safely identified.

In industries where high demands are placed on system availability, the CHECKMASTER 2 enables predictive maintenance to be carried out on surge protective devices. This provides additional security for failure-critical systems.

**i** Your web code: #0147



### Easy selection

The CHECKMASTER 2 has a modular design. Corresponding test adapters are available for the various surge protective devices. Further information about the test adapters required can be found on the next page.



### Convenient scanning

The barcodes on the surge protective devices present a fast and error-free solution for entering items. Plant-specific ID codes or user-defined designations can be entered via the color touch display or read from individually created barcode labels.



### Fast logging and easy data export

The tests are documented in accordance with IEC 62305. The CHECKMASTER 2 saves all test results to the internal memory with mains failure protection. The test reports are available via USB stick for convenient further processing in Office programs.

### CHECKMASTER 2

- Modular test device for pluggable surge protective devices from Phoenix Contact
- Easy and tool-free changing of test adapters
- Integrated programmable logic controller with high-voltage source and constant current source
- Automatic and program-controlled testing of surge protective devices
- Easy operation by means of color touch display with virtual keypad
- User interfaces: German, English
- Further languages available for download: French, Italian, Spanish, Portuguese, Turkish, Russian
- Barcode scanner for automatic identification of surge protective devices and for reading user-specific barcodes (e.g., plant identification codes)
- Plant identification codes can also be entered using the virtual keypad
- USB interface for connecting standard USB sticks
- Easy transfer of test reports to Office programs and easy system software update via USB stick
- No additional software required
- No data cable required
- Power supply cable with SCHUKO connector
- Robust plastic transport case; with removable lid
- Additional compartment for another test adapter
- Calibration certificate

Test adapters are not supplied as standard with the CHECKMASTER 2. The required test adapters must be ordered separately.

### PA-CASE 2 transport case for test adapters

- Padded compartments for holding test adapters for the CHECKMASTER 2
- Test adapters are not supplied as standard with the PA-CASE 2

Free software for updating the CHECKMASTER 2 can be found in the download area on the Phoenix Contact homepage.

The CHECKMASTER 2 is designed for use in industrial environments (EMC: class A product) and may not meet the requirements for radiated disturbance variables for use in residential areas.

Nominal voltage  $U_N$   
Ambient temperature (operation)

#### Description

**Test device**, for testing the correct function of surge protective devices from Phoenix Contact; test adapters must be ordered separately

**Transport case**, to hold four test adapters

**Test adapter**, for testing the correct function of surge protective devices from Phoenix Contact:

FLASHTRAB FLT-CP/SEC and VALVETRAB VAL-CP/SEC

VALVETRAB VAL-MS

PLUGTRAB PT/PLT (width: 17.5 mm)

PLUGTRAB PT/PLT (width: 35 mm)

COMTRAB CTM

FLASHTRAB-SEC-HYBRID

PLUGTRAB UFBK/UAK

TERMITRAB complete



Test device



Transport case



Test adapter

Total width 432 mm

### Technical data

100 V AC ... 240 V AC  
5 °C ... 35 °C

Ordering data			Ordering data			Ordering data		
Type	Order No.	Pcs./Pkt.	Type	Order No.	Pcs./Pkt.	Type	Order No.	Pcs./Pkt.
CHECKMASTER 2	2905256	1	PA-CASE 2	2906272	1	CM 2-PA-FLT/VAL-CP/SEC	2905283	1
						CM 2-PA-VAL-MS	2905265	1
						CM 2-PA-PT/PLT	2905284	1
						CM 2-PA-PT4/PLT3S	2907019	1
						CM 2-PA-CTM	2905282	1
						CM 2-PA-SEC-HYBRID	2907889	1
						CM 2-PA-PT/A	2907891	1
						CM 2-PA-TTC	2908707	1

# Surge protection and interference suppression filters

## Accessories for surge protection

### Feed-through terminal block

- For wiring mixed combinations of lightning current arresters and surge protective devices
- As a system extension for FLASHTRAB and VALVETRAB applications
- Practical wiring of all common applications



Feed-through terminal block

Technical data		
<b>Electrical data</b>		
Maximum continuous operating voltage $U_c$	500 V AC	
Nominal current $I_N$	-	
Impulse discharge curr. $I_{imp}$ (10/350) $\mu$ s	Peak value 100 kA	
<b>General data</b>		
Dimensions W/H/D	17.7 mm / 89.8 mm / 65.5 mm	
Connection data solid/stranded/AWG	0.5...35 mm <sup>2</sup> / - mm <sup>2</sup> / 20 ... 2	
Temperature range	-40 °C ... 85 °C	
Inflammability class in acc. with UL 94	V-0	
Test standards	IEC 60947-7-1 / DIN EN 61643-11 / IEC 61643-1	
Ordering data		
Type	Order No.	Pcs./Pkt.
DK-BIC-35	2749880	1

Description	
<b>Feed-through terminal block</b> with biconnect connecting terminal blocks as wiring aid for lightning current arrester and surge protective device applications.	

## Equipotential bonding and TRABTECH housing

### Equipotential bonding strip

- For main equipotential bonding according to DIN VDE 0100
- As well as for lightning protection equipotential bonding in acc. with DIN EN 62305 TRABTECH housing
- Use in harsh environmental conditions at the installation location
- Suitable for outdoor and indoor installation



Equipotential bonding strip

Ordering data			
Description	Type	Order No.	Pcs./Pkt.
Equipotential bonding strip	PAS-1	2765615	1

### Marking material

- For clear and logical identification
- The multi-section ZB strips can be easily separated
- Can be marked with CMS computer marking system or by hand using B-STIFT



For terminal width 6.2 mm



Marking label for the SEC product range

Description	Ordering data			Ordering data		
	Type	Order No.	Pcs./Pkt.	Type	Order No.	Pcs./Pkt.
<b>Marking labels</b> , corresponding material can be found on the website Can be marked acc. to customer specifications <b>UniCard materials</b> , can be marked with BLUEMARK, corresponding material can be found on our website	ZBN 18 CUS	0825059	1			
<b>Zack marker strip, 5-section, unprinted</b> , corresponding material can be found on our website 5-section <b>Continuous roll</b> , width: 20 mm Color: white Color: yellow	UC-TM 6 GN	0818360	10			
	ZB 12:UNPRINTED	0812120	10			
				EML (20XE)R	0803452	1
				EML (20XE)R YE	0803453	1

### Shield fast connection and wiring bridges

- For connecting cable shielding to cable terminal points
- Easy assembly

#### Wiring bridges

- 1-phase with various numbers of positions



Shield fast connection

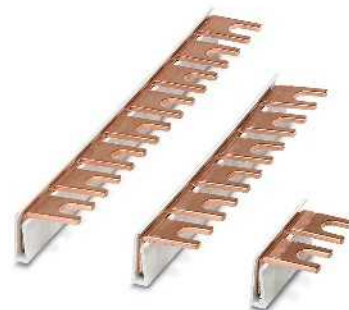

Wiring bridges

Description	Ordering data			Ordering data		
	Type	Order No.	Pcs./Pkt.	Type	Order No.	Pcs./Pkt.
<b>Shield fast connection</b> For Ø 3-6 mm For Ø 5-10 mm	SSA 3-6	2839295	10			
	SSA 5-10	2839512	10			
<b>Wiring bridge</b> , for wiring applications with lightning current arresters and surge protective devices; these can be found on the website under the corresponding items 2-pos. 3-pos. 4-pos. 5-pos. 6-pos. 8-pos. 9-pos. 12-pos. 57-pos. <b>Wiring bridge</b> , 35 mm <sup>2</sup> 6-pos. 8-pos.				MPB 18/1- 2	2809209	10
				MPB 18/1- 3	2809212	10
				MPB 18/1- 4	2809225	10
				MPB 18/1- 5	2817864	10
				MPB 18/1- 6	2748564	10
				MPB 18/1- 8	2748577	10
				MPB 18/1- 9	2748580	10
				MPB 18/1-12	2748593	10
				MPB 18/1-57	2809238	1
				MPB 18/1-6/35	2908705	10
				MPB 18/1-8/35	2908704	10



# Power supplies and UPS

## For superior system availability

The product ranges differ with regard to their design, performance, and functionality. Select the ideal solution based on your requirements:

- QUINT POWER – maximum functionality
- TRIO POWER – robust standard functionality
- UNO POWER – compact basic functionality

The product range is supplemented with designs tailor-made for specific applications:

- MINI POWER for measurement and control technology
- STEP POWER for installation distributors and flat control panels

## Power supplies

Thanks to high-quality products featuring leading technology, our QUINT, TRIO, UNO, MINI, and STEP POWER product ranges optimally equip you for international competition.

## DC/DC converters

Change the voltage level, regenerate the voltage at the end of long cables or enable the creation of independent supply systems with the QUINT and MINI DC/DC converters.

## Redundancy modules

A redundant power supply system is the result of the parallel connection of two power supply units. Optimize this solution with the QUINT ORING and QUINT-S-ORING redundancy modules and the QUINT, TRIO, UNO, and STEP diodes for superior system availability.

## Uninterruptible power supplies (UPS) for control cabinets

IQ technology is the key to an intelligent power supply solution. The UPS monitors and optimizes the energy storage. Avoid interruptions when working with the intelligent UPS for non-stop power.

 Your web code: #0150

## Power supplies and UPS

<b>Selection guides</b>	<b>200</b>
<b>Power supplies</b>	<b>204</b>
QUINT POWER	206
QUINT POWER, with protective coating	216
TRIO POWER	218
UNO POWER	226
MINI POWER	234
STEP POWER	238
<b>DC/DC converters</b>	<b>246</b>
QUINT DC/DC converters	248
QUINT DC/DC converters, with protective coating	254
MINI DC/DC converters	256
<b>Redundancy modules</b>	<b>258</b>
QUINT ORING	260
QUINT S-ORING	262
QUINT DIODE	264
TRIO DIODE	266
UNO DIODE	267
STEP DIODE	267
<b>Accessories</b>	<b>268</b>
<b>Uninterruptible power supplies for the control cabinet</b>	<b>270</b>
Selection guide for QUINT DC-UPS	272
QUINT DC UPS	274
Selection guide for QUINT AC-UPS	278
QUINT AC-UPS	280
TRIO AC-UPS	282
Energy storage for QUINT UPS	284
Accessories	290
Selection guide for UPS modules	292
UPS module with integrated energy storage	294
UPS module with integrated power supply	300
Energy storage for TRIO UPS and MINI UPS	302

# Power supplies and UPS

## Product range overview

### QUINT POWER, with NFC technology, 1~



**24 DC / 5 A**  
Page 206



**24 DC / 10 A**  
Page 206



**24 DC / 20 A**  
Page 207



**24 DC / 5 A**  
Page 208



**24 DC / 10 A**  
Page 208



**24 DC / 20 A**  
Page 209

### QUINT POWER, with NFC technology, 3~

### QUINT POWER 1~



**24 DC / 3.5 A**  
Page 210



**48 DC / 5 A**  
Page 213  
**12 DC / 15 A**  
Page 212



**48 DC / 10 A**  
Page 213  
**12 DC / 20 A**  
Page 212



**24 DC / 40 A**  
Page 210  
**48 DC / 20 A**  
Page 213



**24 DC / 40 A**  
Page 211  
**48 DC / 20 A**  
Page 214

### ... 3~

### QUINT POWER, with protective coating 1~



**1 AC / 24 DC / 5 A CO**  
Page 216



**1 AC / 24 DC / 10 A CO**  
Page 217



**1 AC / 24 DC / 20 A CO**  
Page 217



**3 AC / 24 DC / 20 A CO**  
Page 217

### ... 3~

### TRIO POWER 1~



**24 DC / 3 A**  
Page 218



**24 DC / 5 A**  
Page 219



**24 DC / 5 A B+D**  
Page 219



**24 DC / 10 A**  
Page 220  
**48 DC / 5 A**  
Page 225



**24 DC / 10 A B+D**  
Page 221



**24 DC / 20 A**  
Page 221  
**48 DC / 10 A**  
Page 225

**12 DC / 5 A**  
Page 224

**12 DC / 10 A**  
Page 225

### TRIO POWER 3~



**24 DC / 5 A**  
Page 222



**24 DC / 10 A**  
Page 223



**24 DC / 20 A**  
Page 223



**24 DC / 40 A**  
Page 223

UNO POWER 1~

2~



24 DC / 30 W  
Page 226



24 DC / 60 W  
Page 226  
48 DC / 60 W  
Page 232



24 DC / 90 W  
Page 228



24 DC / 100 W  
Page 227  
48 DC / 100 W  
Page 232  
15 DC / 100 W  
Page 231  
12 DC / 100 W  
Page 229



24 DC / 150 W  
Page 227



24 DC / 240 W  
Page 227



24 DC / 90 W  
Page 228

15 DC / 30 W  
Page 231  
12 DC / 30 W  
Page 229  
5 DC / 25 W  
Page 230

15 DC / 55 W  
Page 231  
12 DC / 55 W  
Page 229  
5 DC / 40 W  
Page 230

MINI POWER 1~



24 DC / 1.3 A  
Page 234  
5 DC / 3 A  
Page 236



24 DC / 1.5 A  
Page 234



24 DC / 2 A  
Page 235  
10 - 15 DC / 2 A  
Page 236  
±15 DC / 1 A  
Page 237



24 DC / 4 A  
Page 235  
24 DC / 100 W  
Page 235  
10 - 15 DC / 8 A  
Page 237



24 DC / 1.5 A EX  
Page 237

STEP POWER 1~



24 DC / 0.5 A  
Page 238  
48 AC / 24 DC / 0.5 A  
Page 239  
12 DC / 1 A  
Page 244  
5 DC / 2 A  
Page 242



24 DC / 0.75 A / FL  
Page 239  
12 DC / 1.5 A / FL  
Page 244



24 DC / 0.75 A  
Page 239  
12 DC / 1.5 A  
Page 245



24 DC / 1.75 A  
Page 240  
12 DC / 3 A  
Page 245



24 DC / 2.5 A  
Page 240  
5 DC / 6.5 A  
Page 243  
12 DC / 5 A  
Page 245  
15 DC / 4 A  
Page 243



24 DC / 4.2 A  
Page 241  
24 DC / 100 W  
Page 241  
48 DC / 2 A  
Page 243  
277 AC / 24 DC / 3.5 A  
Page 241

Redundancy modules – QUINT



24 DC / 2x10 A  
Page 260



24 DC / 2x20 A  
Page 261



24 DC / 2x40  
Page 261



12 - 24 DC / 1x40 A  
Page 262  
12 - 24 DC / 1x40 A /+  
Page 263



12 - 24 DC / 2x20 A  
Page 264  
48 DC / 2x20 A  
Page 265

Redundancy modules – TRIO

- UNO

- STEP



12 - 24 DC / 2x10 A  
Page 266



12 - 24 DC / 2x20 A  
Page 267



5 - 24 DC / 2x10 A  
Page 267



5 - 24 DC / 2x5 A  
Page 267

# Power supplies and UPS

## Product range overview

### QUINT DC/DC converters



**24 DC / 24 DC / 5 A**

Page 248



**24 DC / 24 DC / 10 A**

Page 248



**24 DC / 24 DC / 20 A**

Page 249

**24 DC / 12 DC / 8 A**

Page 249

**24 DC / 48 DC / 5 A**

Page 249

**48 DC / 24 DC / 5 A**

Page 252

**48 DC / 48 DC / 5 A**

Page 253

**12 DC / 24 DC / 5 A**

Page 250

**60 - 72 DC / 24 DC / 10 A**

Page 253

**12 DC / 12 DC / 8 A**

Page 251

**96 - 110 DC / 24 DC / 10 A**

Page 253

### QUINT DC/DC converters, with protective coating



**24 DC / 24 DC / 5 A / CO**

Page 254



**60-72 DC/24 DC/10 A/CO**

Page 255

**96-110 DC/24 DC/10 A/CO**

Page 255



**24 DC / 24 DC / 10 A / CO**

Page 254



**24 DC / 24 DC / 20 A / CO**

Page 255



### UNO DC/DC converters



**350-900 DC/24 DC/60 W**

Page 233

### MINI DC/DC converters



**12 - 24 DC/24 DC/1 A**

Page 256

**48 - 60 DC/24 DC/1 A**

Page 257

**12 - 24 DC/5 - 15 DC/2 A**

Page 256

**12 - 24 DC/48 DC / 0.7 A**

Page 257



**AC power module**

Page 257

### For frequency inverters



**2 AC / 1 DC / 24 DC / 20 A**

Page 215



**600 DC / 24 DC / 20 A**

Page 215

### QUINT DC-UPS



**24 DC / 5 A**

Page 274



**24 DC / 10 A**

Page 275



**24 DC / 20 A**

Page 275



**24 DC / 40 A**

Page 275



**12 DC/5 A/24 DC/10 A**

Page 276

### QUINT AC-UPS



**1 AC / 1 AC / 500 VA**

Page 280



**1 AC / 1 AC / 1 kVA**

Page 281

### TRIO AC-UPS



**1 AC / 1 AC / 750 VA**

Page 282

UPS-CAP for QUINT UPS



24 DC / 10 A / 10 KJ  
Page 284



24 DC / 20 A / 20 KJ  
Page 284



24 DC / 120 WH  
Page 285



24 DC / 925 WH  
Page 285



24 DC / 13 AH  
Page 288



24 DC / 26 AH  
Page 288

UPS-BAT/VRLA for QUINT UPS



24 DC / 5 A / 1.3 AH  
Page 286



24 DC / 3.4 AH  
Page 286



24 DC / 7.2 AH  
Page 287



24 DC / 12 AH  
Page 287



24 DC / 38 AH  
Page 287

UPS with integrated QUINT, UNO, STEP energy storage



24 DC / 5 A / 1.3 AH  
Page 294



24 DC / 10 A / 3.4 AH  
Page 294



24 DC / 60 W  
Page 299



24 DC / 3 A  
Page 298  
12 DC / 4 A  
Page 298

QUINT BUFFER



24 DC / 20 A  
Page 295



24 DC / 40 A  
Page 295



24 DC / 5 A / 4 KJ  
Page 296



24 DC / 5 A / 8 KJ  
Page 297

MINI UPS with integrated power supply and energy storage



1 AC / 24 DC / 2 A  
Page 301



24 DC / 1.3 AH  
Page 302



24 DC / 0.8 AH  
Page 304



1 AC / 24 DC / 5 A  
Page 300



24 DC / 3.4 AH  
Page 303



24 DC / 7.2 AH  
Page 303



24 DC / 12 AH  
Page 303

TRIO UPS with integrated power supply and energy storage



### Leading technology and high quality – power supplies for superior system availability.

Thanks to high-quality products featuring leading technology, with our power supply solutions from the QUINT, TRIO, UNO, MINI, and STEP POWER product ranges, you are optimally equipped to handle competitors on an international scale.

Functionality, performance class, and design are tailored to the demands of various different sectors and always offer the ideal solution. Choose from our wide range of power supplies and DC/DC converters.

### QUINT POWER – maximum functionality

Cost-effective selective fuse protection with SFB Technology:

In order to trip miniature circuit breakers magnetically and quickly, power supplies must be able to supply several times the nominal current for a short period. With SFB (Selective Fuse Breaking) Technology, which supplies up to 6 times the nominal current for 15 ms, a dynamic power reserve is available. Faulty current paths are switched off selectively, the fault is located, and important system parts remain in operation.

### Preventive function monitoring:

Comprehensive diagnostics are provided through constant monitoring of the output voltage and output current. This preventive function monitoring visualizes critical operating states, before errors can occur. The remote monitoring takes place by means of active switching outputs and floating relay contacts.

### Power reserves:

- Easy system extension with static boost with sustained power of up to 125%
  - Start heavy loads with dynamic boost, providing up to 200% power for 5 s
- Adaptable:
- Signaling thresholds and characteristic curves that can be adjusted via NFC maximize system availability

### TRIO POWER – robust standard functionality

The reliable supply of the loads under challenging ambient conditions is ensured by the power supply units, which feature an extremely robust electrical and mechanical design. TRIO POWER supplies up to 1.5 times the nominal current for five seconds with the dynamic boost. Loads with high starting currents can therefore be started without other loads being affected by voltage dips.

### UNO POWER – compact basic functionality

UNO POWER offers maximum energy efficiency thanks to high efficiency of up to 94% and low idling losses below 0.3 W. The extremely high power density of up to 325 W/dm<sup>3</sup> enables a very compact design. Thanks to the wide range of products and the temperature range from -25°C to +70°C, the devices support flexible use.

**i** Your web code: #0151



**Power supplies – a comparison of the advantages**

- QUINT POWER – maximum flexibility up to 1000 W
- TRIO POWER – standard functionality up to 1000 W
- UNO POWER – compact basic functionality up to 240 W



**QUINT POWER**

- The QUINT POWER power supplies enable individual adjustment to the signaling thresholds and characteristic curves via the NFC interface.
- Quick tripping of standard circuit breakers with SFB Technology
  - Easy system extension with static boost
  - Starting of heavy loads with dynamic boost



**TRIO POWER**

- The TRIO POWER power supplies represent standard functionality, high quality, and reliability. They are therefore perfect for use in machine building.
- Robust design
  - Reliable supply of loads with high switch-on currents with the dynamic boost
  - Time savings during installation thanks to Push-in connection technology



**UNO POWER**

- The UNO POWER power supplies offer extremely compact basic functionality.
- The wide range of products covers all common voltage levels
  - Save energy thanks to high efficiency and low idling losses
  - Compact design saves space in the control cabinet



**MINI POWER**

- MINI POWER power supplies in electronics housing for measurement and control technology.
- Maintenance-friendly connection technology: coded COMBICON connectors
  - Active function monitoring with switching output for remote monitoring of the output voltage



**STEP POWER**

- The STEP POWER power supplies are particularly suited to installation distributors and flat control panels.
- Maximum energy efficiency, thanks to incredibly low idling losses and a high degree of efficiency
  - Flexible: snap onto the DIN rail or screw onto a level surface

# Power supplies and UPS

## Power supplies

### QUINT POWER power supplies – maximum functionality

#### QUINT POWER, 1 AC, 24 V DC

- SFB Technology selectively trips standard circuit breakers; loads connected in parallel continue working
- Preventive function monitoring
- Signaling thresholds and characteristic curves that can be adjusted via NFC maximize system availability
- Easy system extension thanks to static boost; starting of difficult loads thanks to dynamic boost
- High noise immunity, thanks to integrated gas-filled surge arrester and mains failure buffer time in excess of 20 ms



new

Power supply,  
1 AC, 24 V DC, 5 A



Ex:

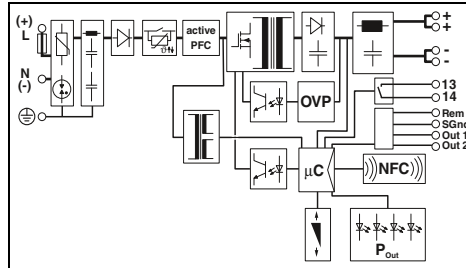

new

Power supply,  
1 AC, 24 V DC, 10 A



Ex:

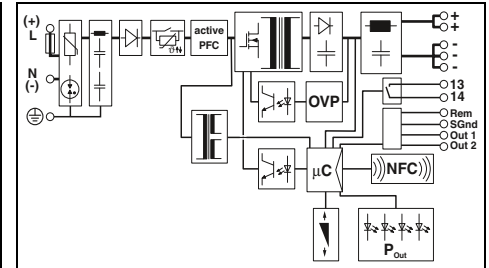

<b>Input data</b>	
Input voltage range	100 V AC ... 240 V AC -15 % ... +10 % 110 V DC ... 250 V DC -18 % ... +40 %
Frequency range ( $f_N$ )	50 Hz ... 60 Hz -10 % ... +10 %
Current consumption (nominal load)	1.7 A (100 V AC) / 1.5 A (120 V AC) 0.9 A (230 V AC) / 0.8 A (240 V AC) 1.6 A (110 V DC) / 0.7 A (250 V DC) typ. 14 A / < 0.3 A <sup>2</sup> s
Inrush current limitation at 25°C / I <sup>2</sup> t	≥ 24 ms (120 V AC) / ≥ 32 ms (230 V AC)
Mains buffering (I <sub>N</sub> , typ.)	
<b>Output data</b>	
Nominal output voltage	24 V DC
Output current I <sub>N</sub> / I <sub>Stat. Boost</sub> / I <sub>Dyn. Boost</sub> / I <sub>SFB</sub>	5 A / 6.25 A / 10 A (5 s) / 30 A (15 ms)
Magnetic circuit breaker tripping	A1...A4 / B2 / C1...C2 / Z1...Z4
Can be connected in parallel/series	Yes / yes
Max. power dissipation (no load/nominal load)	< 3 W (230 V AC) / < 16 W (230 V AC)
Efficiency	typ. 88.8 % (120 V AC) / typ. 89.2 % (230 V AC)
Residual ripple	< 30 mV <sub>pp</sub>
<b>Signaling</b>	
LED signaling	DC OK, utilization indicator
Configurable signal output	Relay contact 13/14, Out 1 digital, Out 2 digital/analog
<b>Signal options</b>	I <sub>Out</sub> , U <sub>Out</sub> , P <sub>Out</sub> , U <sub>In</sub> OK, Operating hours, Temp. OK, OVP
<b>General data</b>	
Weight / Dimensions W x H x D	0.7 kg / 36 x 130 x 125 mm
Assembly instructions	Alignable: 5 mm horizontally, 15 mm next to active components, 50 mm vertically
<b>Connection method</b>	
Input connection data (solid/stranded/AWG)	0.2 - 2.5 mm <sup>2</sup> / 0.2 - 2.5 mm <sup>2</sup> / 30 - 12
Output connection data (solid/stranded/AWG)	0.2 - 2.5 mm <sup>2</sup> / 0.2 - 2.5 mm <sup>2</sup> / 30 - 12
Signal connection data (solid/stranded/AWG)	0.2 - 1.5 mm <sup>2</sup> / 0.2 - 1.5 mm <sup>2</sup> / 24 - 16
Degree of protection / Protection class	IP20 / I
MTBF (IEC 61709, SN 29500)	> 895000 h (40°C)
Ambient temperature (operation)	-25 °C ... 70 °C (> 60 °C derating: 2.5%/K)
Ambient temperature (startup type tested)	-40 °C
<b>Standards/regulations</b>	
Insulation voltage input/output	2.4 kV AC (routine test) / 4 kV AC (type test)
Electromagnetic compatibility	Conformance with EMC Directive 2014/30/EU
Electrical safety	IEC 60950-1/VDE 0805 (SELV)
Safety of power supply units up to 1100 V	DIN EN 61558-2-16
Overvoltage category according to EN 62477-1	III
UL approvals	UL Listed UL 508, UL/C-UL Recognized UL 60950, UL ANSI/ISA-12.12.01 Class I, Division 2, Groups A, B, C, D (Hazardous Location)
Limitation of harmonic line currents	EN 61000-3-2

<b>Technical data</b>	
Input voltage range	100 V AC ... 240 V AC -15 % ... +10 % 110 V DC ... 250 V DC -18 % ... +40 %
Frequency range ( $f_N$ )	50 Hz ... 60 Hz -10 % ... +10 %
Current consumption (nominal load)	1.7 A (100 V AC) / 1.5 A (120 V AC) 0.9 A (230 V AC) / 0.8 A (240 V AC) 1.6 A (110 V DC) / 0.7 A (250 V DC) typ. 14 A / < 0.3 A <sup>2</sup> s
Inrush current limitation at 25°C / I <sup>2</sup> t	≥ 24 ms (120 V AC) / ≥ 32 ms (230 V AC)
Mains buffering (I <sub>N</sub> , typ.)	
<b>Output data</b>	
Nominal output voltage	24 V DC
Output current I <sub>N</sub> / I <sub>Stat. Boost</sub> / I <sub>Dyn. Boost</sub> / I <sub>SFB</sub>	5 A / 6.25 A / 10 A (5 s) / 30 A (15 ms)
Magnetic circuit breaker tripping	A1...A4 / B2 / C1...C2 / Z1...Z4
Can be connected in parallel/series	Yes / yes
Max. power dissipation (no load/nominal load)	< 3 W (230 V AC) / < 16 W (230 V AC)
Efficiency	typ. 88.8 % (120 V AC) / typ. 89.2 % (230 V AC)
Residual ripple	< 30 mV <sub>pp</sub>
<b>Signaling</b>	
LED signaling	DC OK, utilization indicator
Configurable signal output	Relay contact 13/14, Out 1 digital, Out 2 digital/analog
<b>Signal options</b>	I <sub>Out</sub> , U <sub>Out</sub> , P <sub>Out</sub> , U <sub>In</sub> OK, Operating hours, Temp. OK, OVP
<b>General data</b>	
Weight / Dimensions W x H x D	0.7 kg / 36 x 130 x 125 mm
Assembly instructions	Alignable: 5 mm horizontally, 15 mm next to active components, 50 mm vertically
<b>Connection method</b>	
Input connection data (solid/stranded/AWG)	0.2 - 2.5 mm <sup>2</sup> / 0.2 - 2.5 mm <sup>2</sup> / 30 - 12
Output connection data (solid/stranded/AWG)	0.2 - 2.5 mm <sup>2</sup> / 0.2 - 2.5 mm <sup>2</sup> / 30 - 12
Signal connection data (solid/stranded/AWG)	0.2 - 1.5 mm <sup>2</sup> / 0.2 - 1.5 mm <sup>2</sup> / 24 - 16
Degree of protection / Protection class	IP20 / I
MTBF (IEC 61709, SN 29500)	> 895000 h (40°C)
Ambient temperature (operation)	-25 °C ... 70 °C (> 60 °C derating: 2.5%/K)
Ambient temperature (startup type tested)	-40 °C
<b>Standards/regulations</b>	
Insulation voltage input/output	2.4 kV AC (routine test) / 4 kV AC (type test)
Electromagnetic compatibility	Conformance with EMC Directive 2014/30/EU
Electrical safety	IEC 60950-1/VDE 0805 (SELV)
Safety of power supply units up to 1100 V	DIN EN 61558-2-16
Overvoltage category according to EN 62477-1	III
UL approvals	UL Listed UL 508, UL/C-UL Recognized UL 60950, UL ANSI/ISA-12.12.01 Class I, Division 2, Groups A, B, C, D (Hazardous Location)
Limitation of harmonic line currents	EN 61000-3-2

<b>Technical data</b>	
Input voltage range	100 V AC ... 240 V AC -15 % ... +10 % 110 V DC ... 250 V DC -18 % ... +40 %
Frequency range ( $f_N$ )	50 Hz ... 60 Hz -10 % ... +10 %
Current consumption (nominal load)	3.4 A (100 V AC) / 2.8 A (120 V AC) 1.5 A (230 V AC) / 1.5 A (240 V AC) 3 A (110 V DC) / 1.3 A (250 V DC) typ. 18 A / < 0.7 A <sup>2</sup> s
Inrush current limitation at 25°C / I <sup>2</sup> t	≥ 35 ms (120 V AC) / ≥ 35 ms (230 V AC)
Mains buffering (I <sub>N</sub> , typ.)	
<b>Output data</b>	
Nominal output voltage	24 V DC
Output current I <sub>N</sub> / I <sub>Stat. Boost</sub> / I <sub>Dyn. Boost</sub> / I <sub>SFB</sub>	10 A / 12.5 A / 20 A (5 s) / 60 A (15 ms)
Magnetic circuit breaker tripping	A1...A6 / B2...B6 / C1...C3 / Z1...Z6
Can be connected in parallel/series	Yes / yes
Max. power dissipation (no load/nominal load)	< 3 W (230 V AC) / < 17 W (230 V AC)
Efficiency	typ. 92.5 % (120 V AC) / typ. 93.4 % (230 V AC)
Residual ripple	< 80 mV <sub>pp</sub>
<b>Signaling</b>	
LED signaling	DC OK, utilization indicator
Configurable signal output	Relay contact 13/14, Out 1 digital, Out 2 digital/analog
<b>Signal options</b>	I <sub>Out</sub> , U <sub>Out</sub> , P <sub>Out</sub> , U <sub>In</sub> OK, Operating hours, Temp. OK, OVP
<b>General data</b>	
Weight / Dimensions W x H x D	0.9 kg / 50 x 130 x 125 mm
Assembly instructions	Alignable: 5 mm horizontally, 15 mm next to active components, 50 mm vertically
<b>Connection method</b>	
Input connection data (solid/stranded/AWG)	0.2 - 2.5 mm <sup>2</sup> / 0.2 - 2.5 mm <sup>2</sup> / 30 - 12
Output connection data (solid/stranded/AWG)	0.2 - 2.5 mm <sup>2</sup> / 0.2 - 2.5 mm <sup>2</sup> / 30 - 12
Signal connection data (solid/stranded/AWG)	0.2 - 1.5 mm <sup>2</sup> / 0.2 - 1.5 mm <sup>2</sup> / 24 - 16
Degree of protection / Protection class	IP20 / I
MTBF (IEC 61709, SN 29500)	> 783000 h (40°C)
Ambient temperature (operation)	-25 °C ... 70 °C (> 60 °C derating: 2.5%/K)
Ambient temperature (startup type tested)	-40 °C
<b>Standards/regulations</b>	
Insulation voltage input/output	2.4 kV AC (routine test) / 4 kV AC (type test)
Electromagnetic compatibility	Conformance with EMC Directive 2014/30/EU
Electrical safety	IEC 60950-1/VDE 0805 (SELV)
Safety of power supply units up to 1100 V	DIN EN 61558-2-16
Overvoltage category according to EN 62477-1	III
UL approvals	UL Listed UL 508, UL/C-UL Recognized UL 60950, UL ANSI/ISA-12.12.01 Class I, Division 2, Groups A, B, C, D (Hazardous Location)
Limitation of harmonic line currents	EN 61000-3-2

<b>Ordering data</b>	
<b>Description</b>	
<b>Power supply, primary-switched</b>	

<b>Ordering data</b>		
<b>Type</b>	<b>Order No.</b>	<b>Pcs./Pkt.</b>
QUINT4-PS/1AC/24DC/5	2904600	1

<b>Ordering data</b>		
<b>Type</b>	<b>Order No.</b>	<b>Pcs./Pkt.</b>
QUINT4-PS/1AC/24DC/10	2904601	1



new

Power supply,  
1 AC, 24 V DC, 20 A



Ex:

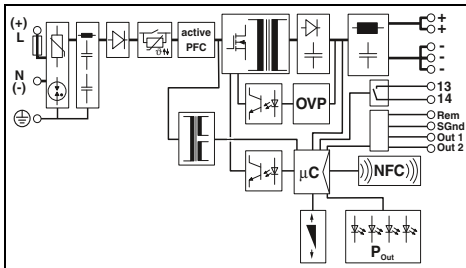

### Technical data

100 V AC ... 240 V AC -15 % ... +10 %  
 110 V DC ... 250 V DC -18 % ... +40 %  
 50 Hz ... 60 Hz -10 % ... +10 %  
 6.8 A (100 V AC) / 5.5 A (120 V AC)  
 2.8 A (230 V AC) / 2.7 A (240 V AC)  
 6 A (110 V DC) / 2.5 A (250 V DC)  
 typ. 11 A / < 0.4 A<sup>2</sup>s  
 ≥ 20 ms (120 V AC) / ≥ 20 ms (230 V AC)

24 V DC  
 20 A / 25 A / 30 A (5 s) / 120 A (15 ms)  
 A1...A16 / B2...B13 / C1...C6 / Z1...Z16  
 Yes / yes  
 < 5 W (230 V AC) / < 32 W (230 V AC)  
 typ. 92.4 % (120 V AC) / typ. 94 % (230 V AC)  
 < 50 mV<sub>pp</sub>

DC OK, utilization indicator  
 Relay contact 13/14, Out 1 digital, Out 2 digital/analog

I<sub>Out</sub>, U<sub>Out</sub>, P<sub>Out</sub>, U<sub>In</sub> OK, Operating hours, Temp. OK, OVP

1.3 kg / 70 x 130 x 125 mm  
 Alignable: 5 mm horizontally, 15 mm next to active components,  
 50 mm vertically  
 Screw connection  
 0.2 - 6 mm<sup>2</sup> / 0.2 - 4 mm<sup>2</sup> / 30 - 10  
 0.2 - 6 mm<sup>2</sup> / 0.2 - 4 mm<sup>2</sup> / 30 - 10  
 0.2 - 1.5 mm<sup>2</sup> / 0.2 - 1.5 mm<sup>2</sup> / 24 - 16  
 IP20 / I  
 > 673000 h (40°C)  
 -25 °C ... 70 °C (> 60 °C derating: 2.5%/K)  
 -40 °C

2.4 kV AC (routine test) / 4 kV AC (type test)  
 Conformance with EMC Directive 2014/30/EU  
 IEC 60950-1/VDE 0805 (SELV)  
 DIN EN 61558-2-16  
 III  
 UL Listed UL 508 , UL/C-UL Recognized UL 60950 ,  
 UL ANSI/ISA-12.12.01 Class I, Division 2, Groups A, B, C, D  
 (Hazardous Location)  
 EN 61000-3-2

### Ordering data

Type	Order No.	Pcs./Pkt.
QUINT4-PS/1AC/24DC/20	2904602	1

# Power supplies and UPS

## Power supplies

### QUINT POWER power supplies – maximum functionality

#### QUINT POWER, 3 AC, 24 V DC

- SFB Technology selectively trips standard circuit breakers; loads connected in parallel continue working
- Preventive function monitoring
- Signaling thresholds and characteristic curves that can be adjusted via NFC maximize system availability
- Easy system extension thanks to static boost; starting of difficult loads thanks to dynamic boost
- High noise immunity, thanks to integrated gas-filled surge arrester and mains failure buffer time in excess of 20 ms



Power supply,  
3 AC, 24 V DC, 5 A

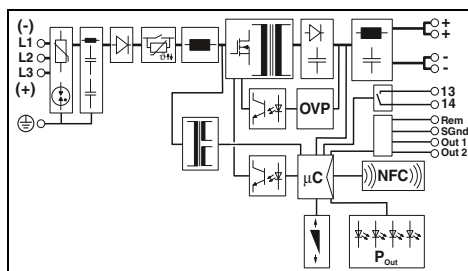

#### Technical data

Input data	
Input voltage range	
Frequency range (f <sub>N</sub> )	
Current consumption (nominal load)	
Inrush current limitation at 25°C / I <sub>N</sub> <sup>2</sup> t	
Mains buffering (I <sub>N</sub> , typ.)	
Output data	
Nominal output voltage	
Output current I <sub>N</sub> / I <sub>Stat. Boost</sub> / I <sub>Dyn. Boost</sub> / I <sub>SFB</sub>	
Magnetic circuit breaker tripping	
Can be connected in parallel/series	
Max. power dissipation (no load/nominal load)	
Efficiency	
Residual ripple	
Signaling	
LED signaling	
Configurable signal output	
Signal options	
General data	
Weight / Dimensions W x H x D	
Assembly instructions	
Connection method	
Input connection data (solid/stranded/AWG)	
Output connection data (solid/stranded/AWG)	
Signal connection data (solid/stranded/AWG)	
Degree of protection / Protection class	
MTBF (IEC 61709, SN 29500)	
Ambient temperature (operation)	
Ambient temperature (startup type tested)	
Standards/regulations	
Insulation voltage input/output	
Electromagnetic compatibility	
Electrical safety	
Safety of power supply units up to 1100 V	
Overvoltage category according to EN 62477-1	
UL approvals	
Limitation of harmonic line currents	

3x 400 V AC ... 500 V AC -20 % ... +10 % 2x 400 V AC ... 500 V AC -10 % ... +10 % ± 300 V DC -25 % ... +30 % 50 Hz ... 60 Hz -10 % ... +10 % 3x 0.6 A (400 V AC) / 3x 0.5 A (480 V AC) 2x 0.9 A (400 V AC) / 2x 0.8 A (480 V AC) 0.3 A (± 300 V DC) typ. 10 A / < 0.2 A <sup>2</sup> s ≥ 28 ms (3x 400 V AC) / ≥ 40 ms (3x 480 V AC)
24 V DC 5 A / 6.25 A / 10 A (5 s) / 30 A (15 ms) A1...A4 / B2 / C1...C2 / Z1...Z4 Yes / yes < 4 W (480 V AC) / < 17 W (480 V AC) typ. 89 % (400 V AC) / typ. 87.5 % (480 V AC) < 30 mV <sub>pp</sub>
DC OK, utilization indicator Relay contact 13/14, Out 1 digital, Out 2 digital/analog
I <sub>Out</sub> , U <sub>Out</sub> , P <sub>Out</sub> , U <sub>In</sub> OK, Operating hours, Temp. OK, OVP
0.6 kg / 36 x 130 x 125 mm Alignable: 5 mm horizontally, 15 mm next to active components, 50 mm vertically Screw connection 0.2 - 6 mm <sup>2</sup> / 0.2 - 4 mm <sup>2</sup> / 30 - 10 0.2 - 2.5 mm <sup>2</sup> / 0.2 - 2.5 mm <sup>2</sup> / 30 - 12 0.2 - 1.5 mm <sup>2</sup> / 0.2 - 1.5 mm <sup>2</sup> / 24 - 16 IP20 / I > 914000 h (40°C) > 25 °C ... 70 °C (> 60 °C derating: 2.5%/K) -40 °C
2.4 kV AC (routine test) / 4 kV AC (type test) Conformance with EMC Directive 2014/30/EU IEC 60950-1/VDE 0805 (SELV) DIN EN 61558-2-16 III UL Listed UL 508 , UL/C-UL Recognized UL 60950 , UL ANSI/ISA-12.12.01 Class I, Division 2, Groups A, B, C, D (Hazardous Location) EN 61000-3-2

#### Ordering data

Type	Order No.	Pcs./Pkt.
QUINT4-PS/3AC/24DC/5	2904620	1



Power supply,  
3 AC, 24 V DC, 10 A

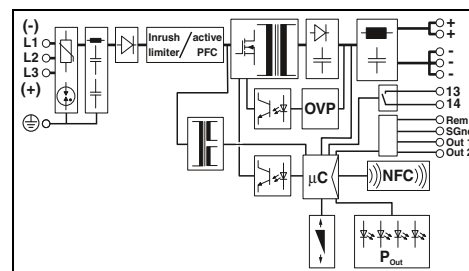

#### Technical data

3x 400 V AC ... 500 V AC -20 % ... +10 % 2x 400 V AC ... 500 V AC -10 % ... +10 % ± 260 V DC ... 300 V DC -13 % ... +30 % 50 Hz ... 60 Hz -10 % ... +10 % 3x 0.5 A (400 V AC) / 3x 0.4 A (480 V AC) 2x 0.8 A (400 V AC) / 2x 0.9 A (480 V AC) 0.7 A (± 260 V DC) / 0.6 A (± 300 V DC) typ. 3 A / < 0.1 A <sup>2</sup> s ≥ 22 ms (3x 400 V AC) / ≥ 22 ms (3x 480 V AC)
24 V DC 10 A / 12.5 A / 20 A (5 s) / 60 A (15 ms) A1...A6 / B2...B6 / C1...C3 / Z1...Z6 Yes / yes < 5 W (480 V AC) / < 20 W (480 V AC) typ. 93 % (400 V AC) / typ. 92.6 % (480 V AC) < 75 mV <sub>pp</sub>
DC OK, utilization indicator Relay contact 13/14, Out 1 digital, Out 2 digital/analog
I <sub>Out</sub> , U <sub>Out</sub> , P <sub>Out</sub> , U <sub>In</sub> OK, Operating hours, Temp. OK, OVP
0.9 kg / 50 x 130 x 125 mm Alignable: 5 mm horizontally, 15 mm next to active components, 50 mm vertically Screw connection 0.2 - 6 mm <sup>2</sup> / 0.2 - 4 mm <sup>2</sup> / 30 - 10 0.2 - 2.5 mm <sup>2</sup> / 0.2 - 2.5 mm <sup>2</sup> / 30 - 12 0.2 - 1.5 mm <sup>2</sup> / 0.2 - 1.5 mm <sup>2</sup> / 24 - 16 IP20 / I > 654000 h (40°C) > 25 °C ... 70 °C (> 60 °C derating: 2.5%/K) -40 °C
2.4 kV AC (routine test) / 4 kV AC (type test) Conformance with EMC Directive 2014/30/EU IEC 60950-1/VDE 0805 (SELV) DIN EN 61558-2-16 III UL Listed UL 508 , UL/C-UL Recognized UL 60950 , UL ANSI/ISA-12.12.01 Class I, Division 2, Groups A, B, C, D (Hazardous Location) EN 61000-3-2

#### Ordering data

Type	Order No.	Pcs./Pkt.
QUINT4-PS/3AC/24DC/10	2904621	1



new

Power supply,  
3 AC, 24 V DC, 20 A

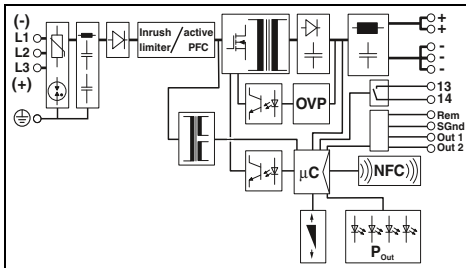

### Technical data

3x 400 V AC ... 500 V AC -20 % ... +10 %  
 2x 400 V AC ... 500 V AC -10 % ... +10 %  
 ± 260 V DC ... 300 V DC -13 % ... +30 %  
 50 Hz ... 60 Hz -10 % ... +10 %  
 3x 1 A (400 V AC) / 3x 0.9 A (480 V AC)  
 2x 1.7 A (400 V AC) / 2x 1.3 A (480 V AC)  
 1.23 A (± 260 V DC) / 1.1 A (± 300 V DC)  
 typ. 2 A / < 0.1 A<sup>2</sup>s  
 ≥ 25 ms (3x 400 V AC) / ≥ 25 ms (3x 480 V AC)

24 V DC  
 20 A / 25 A / 30 A (5 s) / 120 A (15 ms)  
 A1...A16 / B2...B13 / C1...C6 / Z1...Z16  
 Yes / yes  
 < 7 W (480 V AC) / < 33 W (480 V AC)  
 typ. 93.9 % (400 V AC) / typ. 93.8 % (480 V AC)  
 < 60 mV<sub>pp</sub>

DC OK, utilization indicator  
 Relay contact 13/14, Out 1 digital, Out 2 digital/analog

I<sub>Out</sub>, U<sub>Out</sub>, P<sub>Out</sub>, U<sub>In</sub> OK, Operating hours, Temp. OK, OVP

1.1 kg / 70 x 130 x 125 mm  
 Alignable: 5 mm horizontally, 15 mm next to active components,  
 50 mm vertically  
 Screw connection  
 0.2 - 6 mm<sup>2</sup> / 0.2 - 4 mm<sup>2</sup> / 30 - 10  
 0.2 - 6 mm<sup>2</sup> / 0.2 - 4 mm<sup>2</sup> / 30 - 10  
 0.2 - 1.5 mm<sup>2</sup> / 0.2 - 1.5 mm<sup>2</sup> / 24 - 16  
 IP20 / I  
 > 638000 h (40°C)  
 -25 °C ... 70 °C (> 60 °C derating: 2.5%/K)  
 -40 °C

2.4 kV AC (routine test) / 4 kV AC (type test)  
 Conformance with EMC Directive 2014/30/EU  
 IEC 60950-1/VDE 0805 (SELV)  
 DIN EN 61558-2-16  
 III  
 UL Listed UL 508 , UL/C-UL Recognized UL 60950 ,  
 UL ANSI/ISA-12.12.01 Class I, Division 2, Groups A, B, C, D  
 (Hazardous Location)  
 EN 61000-3-2

### Ordering data

Type	Order No.	Pcs./Pkt.
QUINT4-PS/3AC/24DC/20	2904622	1

# Power supplies and UPS

## Power supplies

### QUINT POWER power supplies – maximum functionality

#### QUINT POWER, 1 AC, 24 V DC

- Fast tripping of standard miniature circuit breakers with SFB (Selective Fuse Breaking) Technology dynamic power reserve with up to 6 times the nominal current for 12 ms
- Reliable starting of heavy loads with the static Power Boost power reserve with up to 1.5 times the nominal current
- Preventive function monitoring
- Flexible thanks to input voltage ranges for AC and DC voltages
- Approved for semiconductor production according to SEMI F47-0706



Power supply,  
1 AC, 24 V DC, 3.5 A



Power supply,  
1 AC, 24 V DC, 40 A

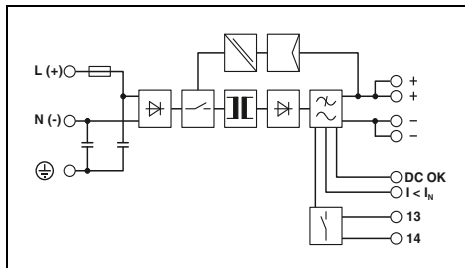

#### Technical data

Input data	
Nominal input voltage range	100 V AC ... 240 V AC
Input voltage range	85 V AC ... 264 V AC 90 V DC ... 350 V DC
Frequency range	45 Hz ... 65 Hz / 0 Hz
Current consumption (nominal load)	1.4 A (120 V AC) / 0.8 A (230 V AC)
Inrush current limitation at 25°C / I <sub>pt</sub>	< 20 A / < 2 A <sup>2</sup> s
Mains buffering (I <sub>n</sub> , typ.)	> 20 ms (120 V AC) / > 80 ms (230 V AC)
Output data	
Nominal output voltage	24 V DC ± 1 %
Setting range of the output voltage (U <sub>set</sub> )	18 V DC ... 29.5 V DC (> 24 V DC, constant capacity restricted)
Output current / Power Boost / SFB (12 ms)	3.5 A / 4 A / 15 A
Magnetic circuit breaker tripping	B2
Can be connected in parallel/series	Yes / yes
Max. power dissipation (no load/nominal load)	3.5 W / 11 W
Efficiency	> 88 % (for 230 V AC and nominal values)
Residual ripple	< 50 mV <sub>pp</sub>
Signaling	
Signaling DC OK	LED, active switching output, relay contact
Boost signaling	LED, active switching output
General data	
Weight / Dimensions W x H x D	0.5 kg / 32 x 130 x 125 mm
Assembly instructions	Alignable: 5 mm horizontally, 15 mm next to active components, 50 mm vertically
Connection method	Plug-in screw connection
Input connection data (solid/stranded/AWG)	0.2 - 2.5 mm <sup>2</sup> / 0.2 - 2.5 mm <sup>2</sup> / 20 - 12
Output connection data (solid/stranded/AWG)	0.2 - 2.5 mm <sup>2</sup> / 0.2 - 2.5 mm <sup>2</sup> / 20 - 12
Signal connection data (solid/stranded/AWG)	0.2 - 2.5 mm <sup>2</sup> / 0.2 - 2.5 mm <sup>2</sup> / 20 - 12
Degree of protection / Protection class	IP20 / I
MTBF (IEC 61709, SN 29500)	> 820000 h (40°C)
Ambient temperature (operation)	-25 °C ... 70 °C (> 60 °C derating: 2.5%/K)
Standards/regulations	
Insulation voltage input/output	2 kV AC (routine test) / 4 kV AC (type test)
Electromagnetic compatibility	Conformance with EMC Directive 2014/30/EU
Electrical safety	IEC 60950-1/VDE 0805 (SELV)
Electronic equipm. for electrical power installations	EN 50178/VDE 0160 (PELV)
Safe isolation	DIN VDE 0100-410
Medical standard	IEC 60601-1, 2 x MOOP
UL approvals	UL Listed UL 508, UL/C-UL Recognized UL 60950-1, UL ANSI/ISA-12.12.01 Class I, Division 2, Groups A, B, C, D (Hazardous Location)
Limitation of harmonic line currents	EN 61000-3-2

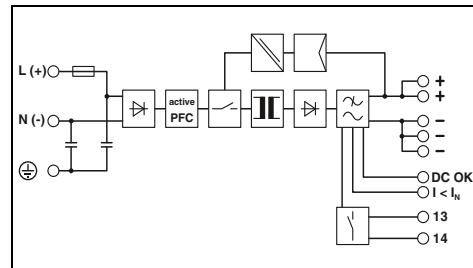

#### Technical data

Input data	
Nominal input voltage range	100 V AC ... 240 V AC
Input voltage range	85 V AC ... 264 V AC 90 V DC ... 350 V DC
Frequency range	45 Hz ... 65 Hz / 0 Hz
Current consumption (nominal load)	8.8 A (120 V AC) / 4.6 A (230 V AC)
Inrush current limitation at 25°C / I <sub>pt</sub>	< 15 A / < 1.7 A <sup>2</sup> s
Mains buffering (I <sub>n</sub> , typ.)	> 35 ms (120 V AC) / > 35 ms (230 V AC)
Output data	
Nominal output voltage	24 V DC ± 1 %
Setting range of the output voltage (U <sub>set</sub> )	18 V DC ... 29.5 V DC (> 24 V DC, constant capacity restricted)
Output current / Power Boost / SFB (12 ms)	40 A / 45 A / 215 A
Magnetic circuit breaker tripping	B2 / B4 / B6 / B10 / B16 / B25 / C2 / C4 / C6 / C13
Can be connected in parallel/series	Yes / yes
Max. power dissipation (no load/nominal load)	14 W / 80 W
Efficiency	> 92 % (for 230 V AC and nominal values)
Residual ripple	< 30 mV <sub>pp</sub>
Signaling	
Signaling DC OK	LED, active switching output, relay contact
Boost signaling	LED, active switching output
General data	
Weight / Dimensions W x H x D	3.3 kg / 180 x 130 x 125 mm
Assembly instructions	Alignable: 5 mm horizontally, 15 mm next to active components, 50 mm vertically
Connection method	Screw connection
Input connection data (solid/stranded/AWG)	0.2 - 6 mm <sup>2</sup> / 0.2 - 4 mm <sup>2</sup> / 14 - 10
Output connection data (solid/stranded/AWG)	0.5 - 16 mm <sup>2</sup> / 0.5 - 16 mm <sup>2</sup> / 8 - 6
Signal connection data (solid/stranded/AWG)	0.2 - 6 mm <sup>2</sup> / 0.2 - 4 mm <sup>2</sup> / 24 - 10
Degree of protection / Protection class	IP20 / I
MTBF (IEC 61709, SN 29500)	> 530000 h (40°C)
Ambient temperature (operation)	-25 °C ... 70 °C (> 60 °C derating: 2.5%/K)
Standards/regulations	
Insulation voltage input/output	2 kV AC (routine test) / 4 kV AC (type test)
Electromagnetic compatibility	Conformance with EMC Directive 2014/30/EU
Electrical safety	IEC 60950-1/VDE 0805 (SELV)
Electronic equipm. for electrical power installations	EN 50178/VDE 0160 (PELV)
Safe isolation	DIN VDE 0100-410, DIN VDE 0106-101
Medical standard	IEC 60601-1, 2 x MOOP
UL approvals	UL Listed UL 508, UL/C-UL Recognized UL 60950-1, UL ANSI/ISA-12.12.01 Class I, Division 2, Groups A, B, C, D (Hazardous Location)
Limitation of harmonic line currents	EN 61000-3-2

#### Ordering data

Description	Type	Order No.	Pcs./Pkt.
Power supply, primary-switched	QUINT-PS/1AC/24DC/ 3.5	2866747	1

#### Ordering data

Description	Type	Order No.	Pcs./Pkt.
Power supply, primary-switched	QUINT-PS/1AC/24DC/40	2866789	1



# Power supplies and UPS

## Power supplies

### QUINT POWER power supplies – maximum functionality

#### QUINT POWER, 1 AC, 12 and 48 V DC

- Quick tripping of standard circuit breakers
- Reliable starting of heavy loads
- Preventive function monitoring
- Flexible thanks to input voltage ranges for AC and DC voltages
- Approved for semiconductor production according to SEMI F47-0706: 12 V DC and 48 V DC, 5 A and 10 A
- Adjustable output voltage of 5 to 18 V DC, or 30 to 56 V DC

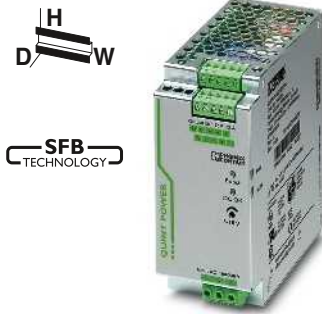

Power supply,  
1 AC, 12 V DC, 15 A



Power supply,  
1 AC, 12 V DC, 20 A

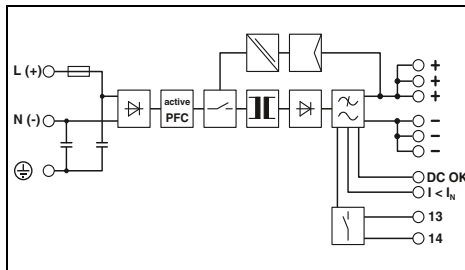

#### Technical data

Input data	
Nominal input voltage range	100 V AC ... 240 V AC
Input voltage range	85 V AC ... 264 V AC 90 V DC ... 350 V DC
Frequency range	45 Hz ... 65 Hz / 0 Hz
Current consumption (nominal load)	1.9 A (120 V AC) / 0.9 A (230 V AC)
Inrush current limitation at 25°C / I <sup>2</sup> t	< 15 A / < 1.5 A <sup>2</sup> s
Mains buffering (I <sub>N</sub> , typ.)	> 65 ms (120 V AC) / > 65 ms (230 V AC)
Output data	
Nominal output voltage	12 V DC ± 1 %
Setting range of the output voltage (U <sub>set</sub> )	5 V DC ... 18 V DC (> 12 V DC, constant capacity restricted)
Output current / Power Boost / SFB (12 ms)	15 A / 16 A / -
Magnetic circuit breaker tripping	B2 / B4 / B6 / C2 / C4
Can be connected in parallel/series	Yes / yes
Max. power dissipation (no load/nominal load)	5 W / 21 W
Efficiency	> 89 % (for 230 V AC and nominal values)
Residual ripple	< 10 mV <sub>pp</sub>
Signaling	
Signaling DC OK	LED, active switching output, relay contact
Boost signaling	LED, active switching output
General data	
Weight / Dimensions W x H x D	1.1 kg / 60 x 130 x 125 mm
Assembly instructions	Alignable: 5 mm horizontally, 15 mm next to active components, 50 mm vertically
Connection method	Plug-in screw connection
Input connection data (solid/stranded/AWG)	0.2 - 2.5 mm <sup>2</sup> / 0.2 - 2.5 mm <sup>2</sup> / 16 - 12
Output connection data (solid/stranded/AWG)	0.2 - 2.5 mm <sup>2</sup> / 0.2 - 2.5 mm <sup>2</sup> / 16 - 12
Signal connection data (solid/stranded/AWG)	0.2 - 2.5 mm <sup>2</sup> / 0.2 - 2.5 mm <sup>2</sup> / 16 - 12
Degree of protection / Protection class	IP20 / I
MTBF (IEC 61709, SN 29500)	> 570000 h (40°C)
Ambient temperature (operation)	-25 °C ... 70 °C (> 60 °C derating: 2.5%/K)
Standards/regulations	
Insulation voltage input/output	2 kV AC (routine test) / 4 kV AC (type test)
Electromagnetic compatibility	Conformance with EMC Directive 2014/30/EU
Electrical safety	IEC 60950-1/VDE 0805 (SELV)
Electronic equipm. for electrical power installations	EN 50178/VDE 0160 (PELV)
Safe isolation	DIN VDE 0100-410
Medical standard	IEC 60601-1, 2 x MOOP
UL approvals	UL Listed UL 508, UL/C-UL Recognized UL 60950-1, UL ANSI/ISA-12.12.01 Class I, Division 2, Groups A, B, C, D (Hazardous Location)
Limitation of harmonic line currents	EN 61000-3-2

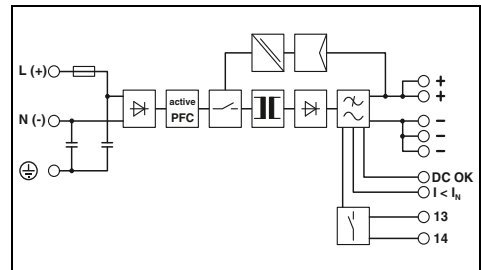

#### Technical data

Input data	
Nominal input voltage range	100 V AC ... 240 V AC
Input voltage range	85 V AC ... 264 V AC 90 V DC ... 350 V DC
Frequency range	45 Hz ... 65 Hz / 0 Hz
Current consumption (nominal load)	2.4 A (120 V AC) / 1.4 A (230 V AC)
Inrush current limitation at 25°C / I <sup>2</sup> t	< 20 A / < 3.2 A <sup>2</sup> s
Mains buffering (I <sub>N</sub> , typ.)	> 40 ms (120 V AC) / > 40 ms (230 V AC)
Output data	
Nominal output voltage	12 V DC ± 1 %
Setting range of the output voltage (U <sub>set</sub> )	5 V DC ... 18 V DC (> 12 V DC, constant capacity restricted)
Output current / Power Boost / SFB (12 ms)	20 A / 26 A / -
Magnetic circuit breaker tripping	B2 / B4 / B6 / B10 / C2 / C4 / C6
Can be connected in parallel/series	Yes / yes
Max. power dissipation (no load/nominal load)	6 W / 29 W
Efficiency	> 90 % (for 230 V AC and nominal values)
Residual ripple	< 50 mV <sub>pp</sub>
Signaling	
Signaling DC OK	LED, active switching output, relay contact
Boost signaling	LED, active switching output
General data	
Weight / Dimensions W x H x D	1.5 kg / 90 x 130 x 125 mm
Assembly instructions	Alignable: 5 mm horizontally, 15 mm next to active components, 50 mm vertically
Connection method	Screw connection
Input connection data (solid/stranded/AWG)	0.2 - 6 mm <sup>2</sup> / 0.2 - 4 mm <sup>2</sup> / 18 - 10
Output connection data (solid/stranded/AWG)	0.2 - 6 mm <sup>2</sup> / 0.2 - 4 mm <sup>2</sup> / 12 - 10
Signal connection data (solid/stranded/AWG)	0.2 - 6 mm <sup>2</sup> / 0.2 - 4 mm <sup>2</sup> / 18 - 10
Degree of protection / Protection class	IP20 / I
MTBF (IEC 61709, SN 29500)	> 600000 h (40°C)
Ambient temperature (operation)	-25 °C ... 70 °C (> 60 °C derating: 2.5%/K)
Standards/regulations	
Insulation voltage input/output	2 kV AC (routine test) / 4 kV AC (type test)
Electromagnetic compatibility	Conformance with EMC Directive 2014/30/EU
Electrical safety	IEC 60950-1/VDE 0805 (SELV)
Electronic equipm. for electrical power installations	EN 50178/VDE 0160 (PELV)
Safe isolation	DIN VDE 0100-410
Medical standard	IEC 60601-1, 2 x MOOP
UL approvals	UL Listed UL 508, UL/C-UL Recognized UL 60950-1, UL ANSI/ISA-12.12.01 Class I, Division 2, Groups A, B, C, D (Hazardous Location)
Limitation of harmonic line currents	EN 61000-3-2

#### Ordering data

Description	Type	Order No.	Pcs./Pkt.
Power supply, primary-switched	QUINT-PS/1AC/12DC/15	2866718	1

#### Ordering data

Description	Type	Order No.	Pcs./Pkt.
Power supply, primary-switched	QUINT-PS/1AC/12DC/20	2866721	1



Power supply,  
1 AC, 48 V DC, 5 A

UL, ENEC, EAC, CB  
Ex:



Power supply,  
1 AC, 48 V DC, 10 A

UL, ENEC, EAC, DNV GL, CB  
Ex:



Power supply,  
1 AC, 48 V DC, 20 A

EAC, UL, DNV GL, CB

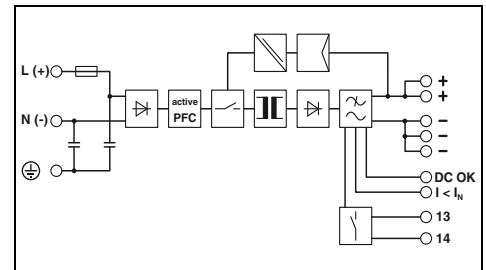
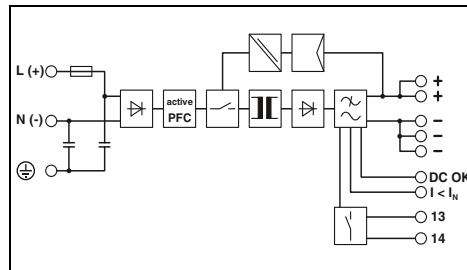
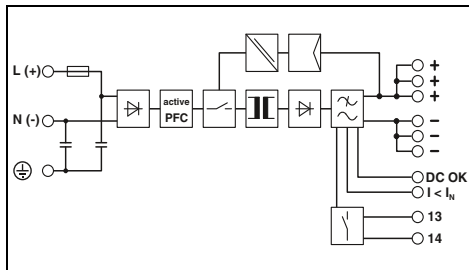

Technical data

100 V AC ... 240 V AC  
85 V AC ... 264 V AC  
90 V DC ... 350 V DC  
45 Hz ... 65 Hz / 0 Hz  
2.8 A (120 V AC) / 1.2 A (230 V AC)  
< 15 A / < 1.5 A<sup>2</sup>s  
> 40 ms (120 V AC) / > 40 ms (230 V AC)

48 V DC ±1 %  
30 V DC ... 56 V DC (> 48 V DC, constant capacity restricted)

5 A / 7.5 A / 30 A  
B2 / B4 / C2  
Yes / No  
7 W / 21 W  
> 92.5 % (for 230 V AC and nominal values)  
< 50 mV<sub>pp</sub>

LED, active switching output, relay contact  
LED, active switching output

1.1 kg / 60 x 130 x 125 mm  
Alignable: 5 mm horizontally, 15 mm next to active components,  
50 mm vertically  
Plug-in screw connection  
0.2 - 2.5 mm<sup>2</sup> / 0.2 - 2.5 mm<sup>2</sup> / 16 - 12  
0.2 - 2.5 mm<sup>2</sup> / 0.2 - 2.5 mm<sup>2</sup> / 16 - 12  
0.2 - 2.5 mm<sup>2</sup> / 0.2 - 2.5 mm<sup>2</sup> / 16 - 12  
IP20 / I  
> 530000 h (40°C)  
-25 °C ... 70 °C (> 60 °C derating: 2.5%/K)

2 kV AC (routine test) / 4 kV AC (type test)  
Conformance with EMC Directive 2014/30/EU  
IEC 60950-1/VDE 0805 (SELV)  
EN 50178/VDE 0160 (PELV)  
DIN VDE 0100-410  
IEC 60601-1, 2 x MOOP  
UL Listed UL 508 , UL/C-UL Recognized UL 60950-1 ,  
UL ANSI/ISA-12.12.01 Class I, Division 2, Groups A, B, C, D  
(Hazardous Location)  
EN 61000-3-2

Technical data

100 V AC ... 240 V AC  
85 V AC ... 264 V AC  
90 V DC ... 350 V DC  
45 Hz ... 65 Hz / 0 Hz  
5.1 A (120 V AC) / 2.3 A (230 V AC)  
< 20 A / < 3.2 A<sup>2</sup>s  
> 20 ms (120 V AC) / > 20 ms (230 V AC)

48 V DC ±1 %  
30 V DC ... 56 V DC (> 48 V DC, constant capacity restricted)

10 A / 13 A / 60 A  
B2 / B4 / B6 / C2 / C4  
Yes / yes  
16 W / 41 W  
> 93 % (for 230 V AC and nominal values)  
< 80 mV<sub>pp</sub>

LED, active switching output, relay contact  
LED, active switching output

1.7 kg / 90 x 130 x 125 mm  
Alignable: 5 mm horizontally, 15 mm next to active components,  
50 mm vertically  
Screw connection  
0.2 - 6 mm<sup>2</sup> / 0.2 - 4 mm<sup>2</sup> / 18 - 10  
0.2 - 6 mm<sup>2</sup> / 0.2 - 4 mm<sup>2</sup> / 12 - 10  
0.2 - 6 mm<sup>2</sup> / 0.2 - 4 mm<sup>2</sup> / 18 - 10  
IP20 / I  
> 530000 h (40°C)  
-25 °C ... 70 °C (> 60 °C derating: 2.5%/K)

2 kV AC (routine test) / 4 kV AC (type test)  
Conformance with EMC Directive 2014/30/EU  
IEC 60950-1/VDE 0805 (SELV)  
EN 50178/VDE 0160 (PELV)  
DIN VDE 0100-410  
IEC 60601-1, 2 x MOOP  
UL Listed UL 508 , UL/C-UL Recognized UL 60950-1 ,  
UL ANSI/ISA-12.12.01 Class I, Division 2, Groups A, B, C, D  
(Hazardous Location)  
EN 61000-3-2

Technical data

100 V AC ... 240 V AC  
120 V DC ... 300 V DC  
85 V AC ... 264 V AC  
90 V DC ... 300 V DC  
45 Hz ... 65 Hz / 0 Hz  
8.7 A (120 V AC) / 4.5 A (230 V AC)  
< 15 A / < 1.6 A<sup>2</sup>s  
> 20 ms (120 V AC) / > 22 ms (230 V AC)

48 V DC ±1 %  
30 V DC ... 56 V DC (> 48 V DC, constant capacity restricted)

20 A / 22.5 A / 100 A  
B2 / B4 / B6 / B10 / C2 / C4 / C6  
Yes / yes  
12 W / 74 W  
> 93 % (for 230 V AC and nominal values)  
< 50 mV<sub>pp</sub>

LED, active switching output, relay contact  
LED, active switching output

3.3 kg / 180 x 130 x 125 mm  
Alignable: 5 mm horizontally, 15 mm next to active components,  
50 mm vertically  
Screw connection  
0.2 - 6 mm<sup>2</sup> / 0.2 - 4 mm<sup>2</sup> / 14 - 10  
0.5 - 16 mm<sup>2</sup> / 0.5 - 16 mm<sup>2</sup> / 8 - 6  
0.2 - 6 mm<sup>2</sup> / 0.2 - 4 mm<sup>2</sup> / 24 - 10  
IP20 / I  
> 523000 h (40°C)  
-25 °C ... 70 °C (> 60 °C derating: 2.5%/K)

2 kV AC (routine test) / 4 kV AC (type test)  
Conformance with EMC Directive 2014/30/EU  
IEC 60950-1/VDE 0805 (SELV)  
EN 50178/VDE 0160 (PELV)  
DIN VDE 0100-410  
-  
UL Listed UL 508 , UL/C-UL Recognized UL 60950-1 ,  
UL ANSI/ISA-12.12.01 Class I, Division 2, Groups A, B, C, D  
(Hazardous Location)  
EN 61000-3-2

Ordering data

Type	Order No.	Pcs./Pkt.
QUINT-PS/1AC/48DC/ 5	2866679	1

Ordering data

Type	Order No.	Pcs./Pkt.
QUINT-PS/1AC/48DC/10	2866682	1

Ordering data

Type	Order No.	Pcs./Pkt.
QUINT-PS/1AC/48DC/20	2866695	1

# Power supplies and UPS

## Power supplies

### QUINT POWER power supplies – maximum functionality

#### QUINT POWER, 3 AC, 48 V DC

- High system availability even in the event of a permanent phase failure
- High surge strength of up to 6 kV thanks to integrated gas-filled surge arresters
- Fast tripping of standard miniature circuit breakers with SFB (Selective Fuse Breaking) Technology dynamic power reserve with up to 6 times the nominal current for 12 ms
- Reliable starting of heavy loads with the static Power Boost power reserve with up to 1.5 times the nominal current
- Preventive function monitoring
- Flexible thanks to input voltage ranges for AC and DC voltages
- Adjustable output voltage of 30 to 56 V DC



Power supply,  
3 AC, 48 V DC, 20 A

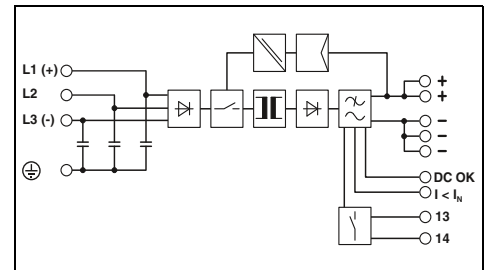

#### Technical data

Input data	
Nominal input voltage range	3x 400 V AC ... 500 V AC
Input voltage range	3x 320 V AC ... 575 V AC 2x 360 V AC ... 575 V AC 450 V DC ... 800 V DC
Frequency range	45 Hz ... 65 Hz / 0 Hz
Current consumption (nominal load)	3x 2.1 A (400 V AC) / 3x 1.7 A (500 V AC)
Inrush current limitation at 25°C / I <sup>2</sup> t	< 20 A / < 1 A <sup>2</sup> s
Mains buffering (I <sub>n</sub> , typ.)	> 25 ms (400 V AC) / > 35 ms (500 V AC)
Output data	
Nominal output voltage	48 V DC ±1%
Setting range of the output voltage (U <sub>set</sub> )	30 V DC ... 56 V DC (> 48 V DC, constant capacity restricted)
Output current / Power Boost / SFB (12 ms)	20 A / 22.5 A / 100 A
Magnetic circuit breaker tripping	B2 / B4 / B6 / B10 / C2 / C4 / C6
Can be connected in parallel/series	Yes / yes
Max. power dissipation (no load/nominal load)	24 W / 70 W
Efficiency	> 93 % (at 400 V AC and nominal values)
Residual ripple	< 50 mV <sub>pp</sub>
Signaling	
Signaling DC OK	LED, active switching output, relay contact
Boost signaling	LED, active switching output
General data	
Weight / Dimensions W x H x D	2.5 kg / 96 x 130 x 179 mm
Assembly instructions	Alignable: 5 mm horizontally, 15 mm next to active components, 50 mm vertically
Connection method	Screw connection
Input connection data (solid/stranded/AWG)	0.2 - 6 mm <sup>2</sup> / 0.2 - 4 mm <sup>2</sup> / 18 - 10
Output connection data (solid/stranded/AWG)	0.5 - 16 mm <sup>2</sup> / 0.5 - 16 mm <sup>2</sup> / 8 - 6
Signal connection data (solid/stranded/AWG)	0.2 - 6 mm <sup>2</sup> / 0.2 - 4 mm <sup>2</sup> / 18 - 10
Degree of protection / Protection class	IP20 / I
MTBF (IEC 61709, SN 29500)	> 509000 h (40°C)
Ambient temperature (operation)	-25 °C ... 70 °C (> 60 °C derating: 2.5%/K)
Standards/regulations	
Insulation voltage input/output	2 kV AC (routine test) / 4 kV AC (type test)
Electromagnetic compatibility	Conformance with EMC Directive 2014/30/EU
Electrical safety	IEC 60950-1/VDE 0805 (SELV)
Electronic equipm. for electrical power installations	EN 50178/VDE 0160 (PELV)
Safe isolation	DIN VDE 0100-410
UL approvals	UL Listed UL 508, UL/C-UL Recognized UL 60950-1 (3-wire + PE, star net), UL ANSI/ISA-12.12.01 Class 1, Division 2, Groups A, B, C, D (Hazardous Location)
Limitation of harmonic line currents	EN 61000-3-2

#### Ordering data

Description	Type	Order No.	Pcs./Pkt.
Power supply, primary-switched	QUINT-PS/3AC/48DC/20	2320827	1

Power supplies for frequency inverters

**QUINT POWER and TRIO POWER for frequency inverters**

- In the event of mains failure, the DC intermediate circuit voltage of the inverter continues to supply all connected 24 V loads without interruption
- Maintenance-free buffer solution: controlled machine stop in the event of mains failure by using the existing capacity in the frequency inverter or by using the kinetic energy of motors

**QUINT POWER**

- Combined solution with a QUINT POWER power supply

**TRIO POWER**

- Standard solution with two TRIO POWER power supplies



Power supply with two separate input circuits for frequency inverters  
2 AC, 1 DC/24 V DC, 20 A



Power supply, 600 V DC, 24 V DC, 20 A

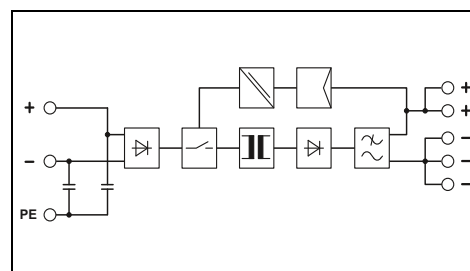
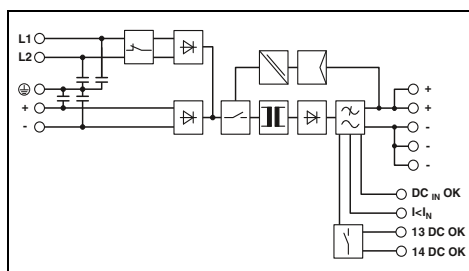

Technical data

Technical data

Input data	
Nominal input voltage range	2x 400 V AC ... 500 V AC 600 V DC
Input voltage range	2x 360 V AC ... 575 V AC 450 V DC ... 840 V DC
Frequency range	45 Hz ... 65 Hz / 0 Hz
Current consumption (nominal load)	2.5 A (400 V AC) / 2.1 A (500 V AC) 0.9 A (600 V DC)
Inrush current limitation at 25°C / I <sup>2</sup> t	< 85 A / < 1.5 A <sup>2</sup> s
Mains buffering (I <sub>N</sub> , typ.)	> 20 ms (400 V AC)
Output data	
Nominal output voltage	24 V DC ±1 %
Setting range of the output voltage (U <sub>set</sub> )	18 V DC ... 29.5 V DC (U <sub>IN</sub> ≥ 360 V AC / 480 V DC) 18 V DC ... 26 V DC (< 480 V DC)
Output current / Power Boost / SFB (20 ms)	20 A / 26 A / 120 A
Magnetic circuit breaker tripping	C6 / B16
Max. power dissipation (no load/nominal load)	11 W / 51 W
Efficiency	> 92 % (600 V DC) / > 90.5 % (400 V AC)
Residual ripple	< 50 mV <sub>pp</sub>
Signaling	
Signaling DC OK	LED, relay contact
Boost signaling	LED, active switching output
Signaling DC <sub>IN</sub> OK	LED, active switching output
General data	
Weight / Dimensions W x H x D	2 kg / 120 x 130 x 125 mm
Assembly instructions	Alignable: 5 mm horizontally, 15 mm next to active components, 50 mm vertically
Connection method	Screw connection
Input connection data (solid/stranded/AWG)	0.2 - 6 mm <sup>2</sup> / 0.2 - 4 mm <sup>2</sup> / 24 - 10
Output connection data (solid/stranded/AWG)	0.2 - 6 mm <sup>2</sup> / 0.2 - 4 mm <sup>2</sup> / 12 - 10
Signal connection data (solid/stranded/AWG)	0.2 - 6 mm <sup>2</sup> / 0.2 - 4 mm <sup>2</sup> / 24 - 10
Degree of protection / Protection class	IP20 / I
MTBF (IEC 61709, SN 29500)	> 860000 h (40°C)
Ambient temperature (operation)	-25 °C ... 70 °C (> 60 °C derating: 2.5%/K)
Standards/regulations	
Insulation voltage input/output	2 kV AC (routine test) / 1.5 kV AC (type test)
Electromagnetic compatibility	Conformance with EMC Directive 2014/30/EU
Electrical safety	EN 60950-1/VDE 0805 (SELV)
Electronic equipm. for electrical power installations	EN 50178/VDE 0160 (PELV)
Safe isolation	DIN VDE 0100-410
UL approvals	UL/C-UL listed UL 508 , UL/C-UL Recognized UL 60950-1

Input data	
Nominal input voltage range	600 V DC
Input voltage range	450 V DC ... 840 V DC
Frequency range	- / 0 Hz
Current consumption (nominal load)	0.9 A (600 V DC)
Inrush current limitation at 25°C / I <sup>2</sup> t	< 26 A / 0.8 A <sup>2</sup> s
Mains buffering (I <sub>N</sub> , typ.)	> 15 ms (600 V DC)
Output data	
Nominal output voltage	24 V DC ±1 %
Setting range of the output voltage (U <sub>set</sub> )	22.5 V DC ... 29.5 V DC (U <sub>IN</sub> > 475 V DC) 22.5 V DC ... 28 V DC (U <sub>IN</sub> ≤ 475 V DC)
Output current / Power Boost / SFB (20 ms)	20 A / - / -
Magnetic circuit breaker tripping	-
Max. power dissipation (no load/nominal load)	3.8 W / 45 W
Efficiency	> 91 % (With 600 V DC and nominal values)
Residual ripple	< 40 mV <sub>pp</sub>
Signaling	
Signaling DC OK	LED
Boost signaling	-
Signaling DC <sub>IN</sub> OK	-
General data	
Weight / Dimensions W x H x D	2 kg / 115 x 130 x 152.5 mm
Assembly instructions	Can be aligned: Horizontally 0 mm, vertically 50 mm
Connection method	Screw connection
Input connection data (solid/stranded/AWG)	0.2 - 2.5 mm <sup>2</sup> / 0.2 - 2.5 mm <sup>2</sup> / 24 - 14
Output connection data (solid/stranded/AWG)	0.5 - 6 mm <sup>2</sup> / 0.5 - 4 mm <sup>2</sup> / 12 - 10
Signal connection data (solid/stranded/AWG)	- / - / -
Degree of protection / Protection class	IP20 / I
MTBF (IEC 61709, SN 29500)	> 701000 h (40°C)
Ambient temperature (operation)	-25 °C ... 70 °C (> 55 °C derating: 2.5%/K)
Standards/regulations	
Insulation voltage input/output	2 kV AC (routine test) / 4 kV AC (type test)
Electromagnetic compatibility	Conformance with EMC Directive 2014/30/EU
Electrical safety	EN 60950-1/VDE 0805 (SELV)
Electronic equipm. for electrical power installations	EN 50178/VDE 0160 (PELV)
Safe isolation	DIN VDE 0100-410
UL approvals	UL/C-UL listed UL 508 , UL/C-UL Recognized UL 60950

Ordering data

Ordering data

Description	
Power supply, primary-switched	

Type	Order No.	Pcs./Pkt.
QUINT-PS/2AC/1DC/24DC/20	2320830	1

Type	Order No.	Pcs./Pkt.
TRIO-PS/600DC/24DC/20	2866530	1





Power supply, with protective coating, 1 AC, 24 V DC, 10 A

UL, ENEC, EAC, DNV GL, ClassNK, CB  
Ex: Ex



Power supply, with protective coating, 1 AC, 24 V DC, 20 A

UL, ENEC, EAC, DNV GL, CB  
Ex: Ex



Power supply, with protective coating, 3 AC, 24 V DC, 20 A

UL, ENEC, EAC, DNV GL, CB  
Ex: Ex

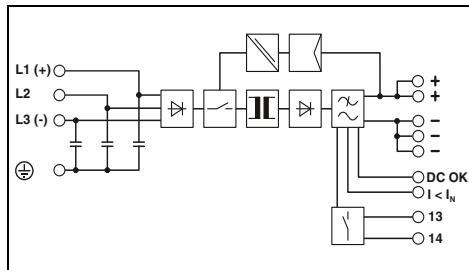
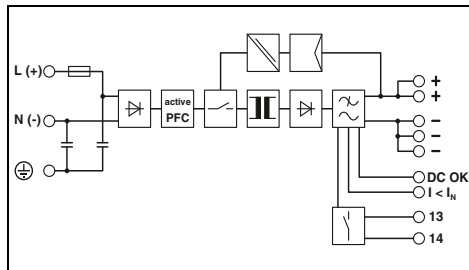
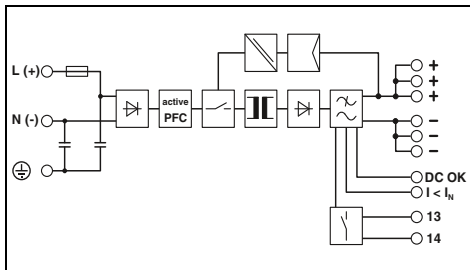

Technical data

Technical data

Technical data

100 V AC ... 240 V AC  
110 V DC ... 250 V DC  
85 V AC ... 264 V AC  
90 V DC ... 410 V DC +5 %

45 Hz ... 65 Hz / 0 Hz  
2.2 A (120 V AC) / 1.3 A (230 V AC)  
< 15 A / < 1.5 A<sup>2</sup>s  
> 36 ms (120 V AC) / > 36 ms (230 V AC)

24 V DC ±1 %  
18 V DC ... 29.5 V DC (> 24 V DC, constant capacity restricted)

10 A / 15 A / 60 A  
B2 / B4 / B6 / C2 / C4  
Yes / yes  
9.1 W / 22 W  
> 92.5 % (for 230 V AC and nominal values)  
< 50 mV<sub>pp</sub>

LED, active switching output, relay contact  
LED, active switching output

1.1 kg / 60 x 130 x 125 mm  
Alignable: 5 mm horizontally, 15 mm next to active components, 50 mm vertically  
Plug-in screw connection  
0.2 - 2.5 mm<sup>2</sup> / 0.2 - 2.5 mm<sup>2</sup> / 16 - 12  
0.2 - 2.5 mm<sup>2</sup> / 0.2 - 2.5 mm<sup>2</sup> / 16 - 12  
0.2 - 2.5 mm<sup>2</sup> / 0.2 - 2.5 mm<sup>2</sup> / 16 - 12  
IP20 / I  
> 535000 h (40°C)  
-40 °C ... 70 °C (> 60 °C derating: 2.5%/K)

2 kV AC (routine test) / 4 kV AC (type test)  
Conformance with EMC Directive 2014/30/EU  
IEC 60950-1/VDE 0805 (SELV)  
EN 50178/VDE 0160 (PELV)  
DIN VDE 0100-410  
EN 50121-4 / EN 50155  
UL/C-UL listed UL 508 , UL/C-UL Recognized UL 60950 ,  
UL ANSI/ISA-12.12.01 Class I, Division 2, Groups A, B, C, D  
(Hazardous Location)  
EN 61000-3-2

100 V AC ... 240 V AC  
110 V DC ... 250 V DC  
85 V AC ... 264 V AC  
90 V DC ... 410 V DC +5 %

45 Hz ... 65 Hz / 0 Hz  
4.5 A (120 V AC) / 2.5 A (230 V AC)  
< 20 A / < 3.2 A<sup>2</sup>s  
> 32 ms (120 V AC) / > 32 ms (230 V AC)

24 V DC ±1 %  
18 V DC ... 29.5 V DC (> 24 V DC, constant capacity restricted)

20 A / 26 A / 120 A  
B2 / B4 / B6 / B10 / B16 / C2 / C4 / C6  
Yes / yes  
8 W / 40 W  
> 93 % (for 230 V AC and nominal values)  
< 30 mV<sub>pp</sub>

LED, active switching output, relay contact  
LED, active switching output

1.7 kg / 90 x 130 x 125 mm  
Alignable: 5 mm horizontally, 15 mm next to active components, 50 mm vertically  
Screw connection  
0.2 - 6 mm<sup>2</sup> / 0.2 - 4 mm<sup>2</sup> / 18 - 10  
0.2 - 6 mm<sup>2</sup> / 0.2 - 4 mm<sup>2</sup> / 12 - 10  
0.2 - 6 mm<sup>2</sup> / 0.2 - 4 mm<sup>2</sup> / 18 - 10  
IP20 / I  
> 520000 h (40°C)  
-40 °C ... 70 °C (> 60 °C derating: 2.5%/K)

2 kV AC (routine test) / 4 kV AC (type test)  
Conformance with EMC Directive 2014/30/EU  
IEC 60950-1/VDE 0805 (SELV)  
EN 50178/VDE 0160 (PELV)  
DIN VDE 0100-410  
EN 50121-4 / EN 50155  
UL/C-UL listed UL 508 , UL/C-UL Recognized UL 60950 ,  
UL ANSI/ISA-12.12.01 Class I, Division 2, Groups A, B, C, D  
(Hazardous Location)  
EN 61000-3-2

3x 400 V AC ... 500 V AC

3x 320 V AC ... 575 V AC  
2x 360 V AC ... 575 V AC  
450 V DC ... 800 V DC  
45 Hz ... 65 Hz / 0 Hz  
3x 1.6 A (400 V AC) / 3x 1.3 A (500 V AC)  
< 20 A / < 3.2 A<sup>2</sup>s  
> 28 ms (400 V AC) / > 43 ms (500 V AC)

24 V DC ±1 %  
18 V DC ... 29.5 V DC (> 24 V DC, constant capacity restricted)

20 A / 26 A / 120 A  
B2 / B4 / B6 / B10 / B16 / C2 / C4 / C6  
Yes / yes  
11 W / 40 W  
> 93 % (at 400 V AC and nominal values)  
< 40 mV<sub>pp</sub>

LED, active switching output, relay contact  
LED, active switching output

1.5 kg / 69 x 130 x 125 mm  
Alignable: 5 mm horizontally, 15 mm next to active components, 50 mm vertically  
Screw connection  
0.2 - 6 mm<sup>2</sup> / 0.2 - 4 mm<sup>2</sup> / 18 - 10  
0.2 - 6 mm<sup>2</sup> / 0.2 - 4 mm<sup>2</sup> / 12 - 10  
0.2 - 6 mm<sup>2</sup> / 0.2 - 4 mm<sup>2</sup> / 18 - 10  
IP20 / I  
> 534000 h (40°C)  
-40 °C ... 70 °C (> 60 °C derating: 2.5%/K)

2 kV AC (routine test) / 4 kV AC (type test)  
Conformance with EMC Directive 2014/30/EU  
IEC 60950-1/VDE 0805 (SELV)  
EN 50178/VDE 0160 (PELV)  
DIN VDE 0100-410  
EN 50121-4 / EN 50155  
UL/C-UL listed UL 508 , UL/C-UL Recognized UL 60950-1  
(3-wire + PE, star net) , UL ANSI/ISA-12.12.01 Class I, Division 2,  
Groups A, B, C, D (Hazardous Location)  
EN 61000-3-2

Ordering data

Ordering data

Ordering data

Type	Order No.	Pcs./Pkt.
QUINT-PS/1AC/24DC/10/CO	2320911	1

Type	Order No.	Pcs./Pkt.
QUINT-PS/1AC/24DC/20/CO	2320898	1

Type	Order No.	Pcs./Pkt.
QUINT-PS/3AC/24DC/20/CO	2320924	1

# Power supplies and UPS

## Power supplies

### TRIO POWER power supplies – robust standard functionality

#### TRIO POWER 1 AC, 24 V DC

- High operational reliability thanks to the robust design
- Wide temperature range from -25°C to +70°C as well as device startup at -40°C (type-tested)
- Reliable starting of dynamic loads with the dynamic boost, which supplies up to 1.5 times the nominal current for 5 seconds
- Time savings during installation, thanks to the use of tool-free Push-in connection technology
- Space savings in the control cabinet thanks to the narrow design
- Active function monitoring with DC OK LED and relay contact
- Input voltage range for DC voltage of 110 ... 250 V DC
- Third negative terminal block for grounding on the secondary side
- Maximum availability thanks to high MTBF (mean time between failure)
- Compensation of voltage drops by means of output voltage that can be set on the front

#### TRIO POWER, NEC Class 2

Output power limited to 100 W

- Specifically for applications that require certification according to UL 1310/508 Listed Class 2

#### TRIO POWER, Bridge and Deck

Optimized for use on the ship's bridge



Power supply,  
1 AC, 24 V DC, 3 A  
NEC Class 2

UL ENEC DNV GL CB  
Ex: IECEx

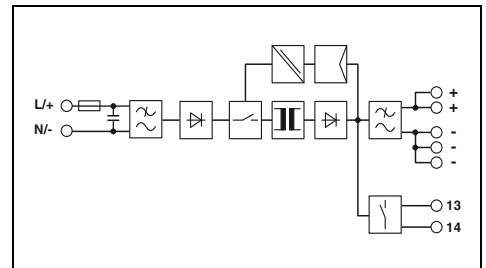

#### Technical data

Input data	100 V AC ... 240 V AC -15 % ... +10 % 110 V DC ... 250 V DC
Nominal input voltage range	85 V AC ... 264 V AC 99 V DC ... 275 V DC
Input voltage range	50 Hz ... 60 Hz
Frequency range	1.4 A (100 V AC) / 0.7 A (240 V AC) 0.8 A (110 V DC) / 0.3 A (250 V DC)
Current consumption (nominal load)	≤ 15 A / < 0.26 A <sup>2</sup> s > 10 ms (120 V AC) / > 20 ms (230 V AC)
Inrush current limitation at 25°C / I <sub>tr</sub>	
Mains buffering (I <sub>n</sub> , typ.)	
Output data	24 V DC ±1 % 24 V DC ... 28 V DC (> 24 V DC, constant capacity restricted)
Nominal output voltage	
Setting range of the output voltage (U <sub>Set</sub> )	3 A / - yes, with redundancy module / yes < 1 W / < 10 W > 89 % (for 230 V AC and nominal values) ≤ 50 mV <sub>pp</sub>
Output current / Dynamic Boost (5 s)	
Can be connected in parallel/series	
Max. power dissipation (no load/nominal load)	
Efficiency	
Residual ripple	
Signaling	LED, floating signal contact
Signaling DC OK	
General data	0.35 kg / 30 x 130 x 115 mm Can be aligned: Horizontally 0 mm (≤ 40 °C) 10 mm (≤ 70 °C), vertically 50 mm Push-in connection 0.2 - 4 mm <sup>2</sup> / 0.2 - 2.5 mm <sup>2</sup> / 24 - 12 0.2 - 4 mm <sup>2</sup> / 0.2 - 2.5 mm <sup>2</sup> / 24 - 12 IP20 / II > 2000000 h (40°C) -25 °C ... 70 °C (> 60 °C derating: 2.5%/K)
Weight / Dimensions W x H x D	
Assembly instructions	
Connection method	
Input connection data (solid/stranded/AWG)	
Output connection data (solid/stranded/AWG)	
Degree of protection / Protection class	
MTBF (IEC 61709, SN 29500)	
Ambient temperature (operation)	
Standards/regulations	1.5 kV AC (routine test) / 3 kV AC (type test) Conformance with EMC Directive 2014/30/EU IEC 60950-1/VDE 0805 (SELV) EN 50178/VDE 0160 (PELV) DIN VDE 0100-410 UL Listed UL 508, UL/C-UL Recognized UL 60950-1, NEC Class 2 as per UL 1310 EN 61000-3-2
Insulation voltage input/output	
Electromagnetic compatibility	
Electrical safety	
Electronic equipm. for electrical power installations	
Safe isolation	
UL approvals	
Limitation of harmonic line currents	

#### Ordering data

Description	Type	Order No.	Pcs./Pkt.
Power supply, primary-switched	TRIO-PS-2G/1AC/24DC/3/C2LPS	2903147	1



**Power supply,  
1 AC, 24 V DC, 5 A**



new

**Power supply, Bridge and Deck  
1 AC, 24 V DC, 5 A**

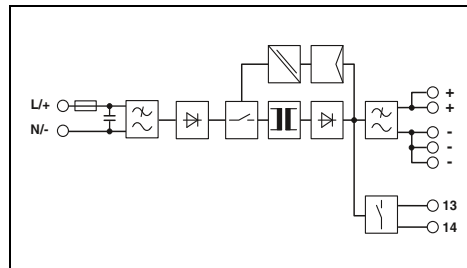
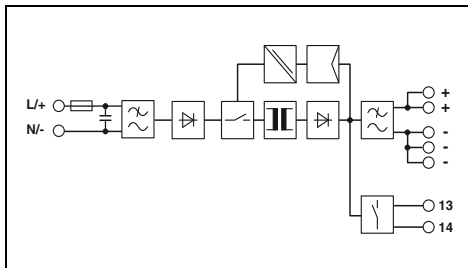

**Technical data**

100 V AC ... 240 V AC -15 % ... +10 %  
 110 V DC ... 250 V DC  
 85 V AC ... 264 V AC  
 99 V DC ... 275 V DC  
 50 Hz ... 60 Hz  
 2.2 A (100 V AC) / 1.1 A (240 V AC)  
 1.4 A (110 V DC) / 0.6 A (250 V DC)  
 ≤ 16 A / < 0.6 A<sup>2</sup>s  
 > 20 ms (120 V AC) / > 100 ms (230 V AC)

24 V DC ±1 %  
 24 V DC ... 28 V DC (> 24 V DC, constant capacity restricted)

5 A / 7.5 A  
 yes, with redundancy module / yes  
 < 1 W / < 16 W  
 > 90 % (for 230 V AC and nominal values)  
 ≤ 50 mV<sub>pp</sub>

LED, floating signal contact

0.45 kg / 35 x 130 x 115 mm  
 Can be aligned: Horizontally 0 mm (≤ 40 °C) 10 mm (≤ 70 °C), vertically 50 mm  
 Push-in connection  
 0.2 - 4 mm<sup>2</sup> / 0.2 - 2.5 mm<sup>2</sup> / 24 - 12  
 0.2 - 4 mm<sup>2</sup> / 0.2 - 2.5 mm<sup>2</sup> / 24 - 12  
 IP20 / II  
 > 1970000 h (40 °C)  
 -25 °C ... 70 °C (> 60 °C derating: 2.5%/K)

1.5 kV AC (routine test) / 3 kV AC (type test)  
 Conformance with EMC Directive 2014/30/EU  
 IEC 60950-1/VDE 0805 (SELV)  
 EN 50178/VDE 0160 (PELV)  
 DIN VDE 0100-410  
 UL Listed UL 508 , UL/C-UL Recognized UL 60950-1

EN 61000-3-2

**Ordering data**

Type	Order No.	Pcs./Pkt.
TRIO-PS-2G/1AC/24DC/5	2903148	1

**Technical data**

100 V AC ... 240 V AC -15 % ... +10 %  
 110 V DC ... 250 V DC  
 85 V AC ... 264 V AC  
 99 V DC ... 275 V DC  
 50 Hz ... 60 Hz  
 2.2 A (100 V AC) / 1.1 A (240 V AC)  
 1.4 A (110 V DC) / 0.6 A (250 V DC)  
 ≤ 16 A / < 0.6 A<sup>2</sup>s  
 > 20 ms (120 V AC) / > 100 ms (230 V AC)

24 V DC ±1 %  
 24 V DC ... 28 V DC (> 24 V DC, constant capacity restricted)

5 A / 7.5 A  
 yes, with redundancy module / yes  
 < 1 W / < 16 W  
 > 89 % (for 230 V AC and nominal values)  
 ≤ 50 mV<sub>pp</sub>

LED, floating signal contact

0.45 kg / 35 x 130 x 115 mm  
 Can be aligned: Horizontally 0 mm (≤ 40 °C) 10 mm (≤ 70 °C), vertically 50 mm  
 Push-in connection  
 0.2 - 4 mm<sup>2</sup> / 0.2 - 2.5 mm<sup>2</sup> / 24 - 12  
 0.2 - 4 mm<sup>2</sup> / 0.2 - 2.5 mm<sup>2</sup> / 24 - 12  
 IP20 / II  
 > 1970000 h (40 °C)  
 -25 °C ... 70 °C (> 60 °C derating: 2.5%/K)

1.5 kV AC (routine test) / 3 kV AC (type test)  
 Conformance with EMC Directive 2014/30/EU  
 IEC 60950-1/VDE 0805 (SELV)  
 EN 50178/VDE 0160 (PELV)  
 DIN VDE 0100-410  
 UL Listed UL 508 , UL/C-UL Recognized UL 60950-1

EN 61000-3-2

**Ordering data**

Type	Order No.	Pcs./Pkt.
TRIO-PS-2G/1AC/24DC/5/B+D	2903144	1

# Power supplies and UPS

## Power supplies

### TRIO POWER power supplies – robust standard functionality

#### TRIO POWER 1 AC, 24 V DC

- High operational reliability thanks to the robust design
- Wide temperature range from -25°C to +70°C as well as device startup at -40°C (type-tested)
- Reliable starting of dynamic loads with the dynamic boost, which supplies up to 1.5 times the nominal current for 5 seconds
- Time savings during installation, thanks to the use of tool-free Push-in connection technology
- Space savings in the control cabinet thanks to the narrow design
- Active function monitoring with DC OK LED and relay contact
- Input voltage range for DC voltage of 110 ... 250 V DC
- Third negative terminal block for grounding on the secondary side
- Maximum availability thanks to high MTBF (mean time between failure)
- Compensation of voltage drops by means of output voltage that can be set on the front

#### TRIO POWER, NEC Class 2

Output power limited to 100 W

- Specifically for applications that require certification according to UL 1310/508 Listed Class 2

#### TRIO POWER, Bridge and Deck

Optimized for use on the ship's bridge



Power supply,  
1 AC, 24 V DC, 10 A

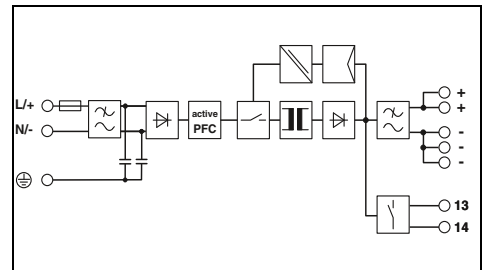

<b>Input data</b>	Nominal input voltage range
Input voltage range	Frequency range
Current consumption (nominal load)	Inrush current limitation at 25°C / I <sub>rt</sub>
Mains buffering (I <sub>h</sub> , typ.)	<b>Output data</b>
Nominal output voltage	Setting range of the output voltage (U <sub>set</sub> )
Output current / Dynamic Boost (5 s)	Can be connected in parallel/series
Max. power dissipation (no load/nominal load)	Efficiency
Residual ripple	Signaling
Signaling DC OK	<b>General data</b>
Weight / Dimensions W x H x D	Assembly instructions
Connection method	Input connection data (solid/stranded/AWG)
Output connection data (solid/stranded/AWG)	Degree of protection / Protection class
MTBF (IEC 61709, SN 29500)	Ambient temperature (operation)
<b>Standards/regulations</b>	Insulation voltage input/output
Electromagnetic compatibility	Electrical safety
Electronic equipm. for electrical power installations	Safe isolation
UL approvals	Limitation of harmonic line currents

<b>Technical data</b>		
100 V AC ... 240 V AC -15 % ... +10 %	110 V DC ... 250 V DC	85 V AC ... 264 V AC
99 V DC ... 275 V DC	50 Hz ... 60 Hz	3.1 A (100 V AC) / 1.4 A (240 V AC)
≤ 25 A / < 0.5 A <sup>2</sup> s	> 15 ms (120 V AC) / > 15 ms (230 V AC)	24 V DC ±1 %
24 V DC ... 28 V DC (> 24 V DC, constant capacity restricted)	10 A / 15 A	yes, with redundancy module / yes
< 5.1 W (230 V) / < 25 W	> 91 % (for 230 V AC and nominal values)	≤ 10 mV <sub>pp</sub>
LED, floating signal contact	1 kg / 42 x 130 x 160 mm	Can be aligned: Horizontally 0 mm (≤ 40 °C) 10 mm (≤ 70 °C), vertically 50 mm
Push-in connection	0.2 - 4 mm <sup>2</sup> / 0.2 - 2.5 mm <sup>2</sup> / 24 - 12	0.2 - 4 mm <sup>2</sup> / 0.2 - 2.5 mm <sup>2</sup> / 24 - 12
IP20 / I	> 1000000 h (40°C)	-25 °C ... 70 °C (> 60 °C derating: 2.5%/K)
1.5 kV AC (routine test) / 3 kV AC (type test)	Conformance with EMC Directive 2014/30/EU	IEC 60950-1/VDE 0805 (SELV)
EN 50178/VDE 0160 (PELV)	DIN VDE 0100-410	UL Listed UL 508, UL/C-UL Recognized UL 60950-1
EN 61000-3-2		

<b>Description</b>
Power supply, primary-switched

<b>Ordering data</b>		
<b>Type</b>	<b>Order No.</b>	<b>Pcs./Pkt.</b>
TRIO-PS-2G/1AC/24DC/10	2903149	1



new

**Power supply, Bridge and Deck**  
1 AC, 24 V DC, 10 A



**Power supply,**  
1 AC, 24 V DC, 20 A

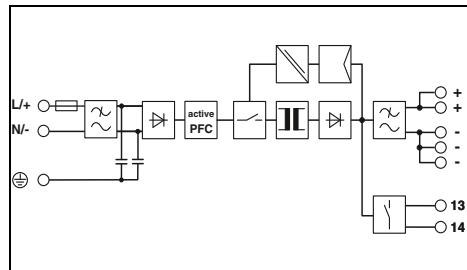
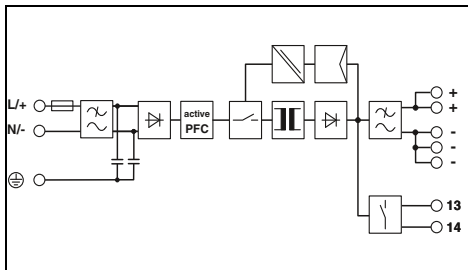

**Technical data**

100 V AC ... 240 V AC -15 % ... +10 %  
110 V DC ... 250 V DC  
85 V AC ... 264 V AC  
99 V DC ... 275 V DC  
50 Hz ... 60 Hz  
3.1 A (100 V AC) / 1.4 A (240 V AC)  
≤ 25 A / < 0.5 A²s  
> 15 ms (120 V AC) / > 15 ms (230 V AC)

24 V DC ±1 %  
24 V DC ... 28 V DC (> 24 V DC, constant capacity restricted)

10 A / 15 A  
yes, with redundancy module / yes  
< 5.1 W / < 25 W  
> 91 % (for 230 V AC and nominal values)  
≤ 10 mV<sub>pp</sub>

LED, floating signal contact

1 kg / 42 x 130 x 160 mm  
Can be aligned: Horizontally 0 mm (≤ 40 °C) 10 mm (≤ 70 °C), vertically 50 mm  
Push-in connection  
0.2 - 4 mm² / 0.2 - 2.5 mm² / 24 - 12  
0.2 - 4 mm² / 0.2 - 2.5 mm² / 24 - 12  
IP20 / I  
> 1000000 h (40°C)  
-25 °C ... 70 °C (> 60 °C derating: 2.5%/K)

1.5 kV AC (routine test) / 3 kV AC (type test)  
Conformance with EMC Directive 2014/30/EU  
IEC 60950-1/VDE 0805 (SELV)  
EN 50178/VDE 0160 (PELV)  
DIN VDE 0100-410  
UL Listed UL 508 , UL/C-UL Recognized UL 60950-1  
EN 61000-3-2

**Ordering data**

Type	Order No.	Pcs./Pkt.
TRIO-PS-2G/1AC/24DC/10/B+D	2903145	1

**Technical data**

100 V AC ... 240 V AC -15 % ... +10 %  
110 V DC ... 250 V DC  
85 V AC ... 264 V AC  
99 V DC ... 275 V DC  
50 Hz ... 60 Hz  
5.6 A (100 V AC) / 2.4 A (240 V AC)  
≤ 20 A / < 0.9 A²s  
> 10 ms (120 V AC) / > 15 ms (230 V AC)

24 V DC ±1 %  
24 V DC ... 28 V DC (> 24 V DC, constant capacity restricted)

20 A / 30 A  
yes, with redundancy module / yes  
< 5.7 W / < 44 W  
> 93 % (for 230 V AC and nominal values)  
≤ 30 mV<sub>pp</sub>

LED, floating signal contact

1.5 kg / 68 x 130 x 160 mm  
Can be aligned: Horizontally 0 mm (≤ 40 °C) 10 mm (≤ 70 °C), vertically 50 mm  
Push-in connection  
0.2 - 4 mm² / 0.2 - 2.5 mm² / 24 - 12  
0.2 - 10 mm² / 0.2 - 6 mm² / 24 - 8  
IP20 / I  
> 1000000 h (40°C)  
-25 °C ... 70 °C (> 60 °C derating: 2.5%/K)

1.5 kV AC (routine test) / 3 kV AC (type test)  
Conformance with EMC Directive 2014/30/EU  
IEC 60950-1/VDE 0805 (SELV)  
EN 50178/VDE 0160 (PELV)  
DIN VDE 0100-410  
UL Listed UL 508 , UL/C-UL Recognized UL 60950-1  
EN 61000-3-2

**Ordering data**

Type	Order No.	Pcs./Pkt.
TRIO-PS-2G/1AC/24DC/20	2903151	1

# Power supplies and UPS

## Power supplies

### TRIO POWER power supplies – robust standard functionality

#### TRIO POWER 3 AC, 24 V DC

- High operational reliability thanks to the robust design
- Wide temperature range from -25°C to +70°C as well as device startup at -40°C (type-tested)
- Reliable starting of dynamic loads with the dynamic boost, which supplies up to 1.5 times the nominal current for 5 seconds
- Time savings during installation, thanks to the use of tool-free Push-in connection technology
- Space savings in the control cabinet thanks to the narrow design
- Active function monitoring with DC OK LED and relay contact
- Third negative terminal block for grounding on the secondary side
- Maximum availability thanks to high MTBF (mean time between failure)
- Compensation of voltage drops by means of output voltage that can be set on the front



Power supply,  
3 AC, 24 V DC, 5 A

Ex:

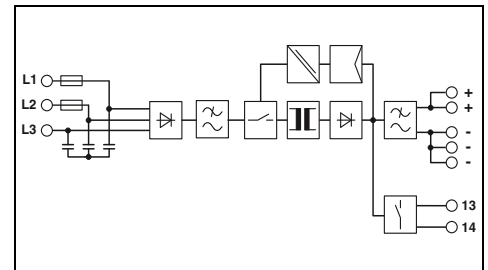

#### Technical data

Input data	
Nominal input voltage range	3x 400 V AC ... 500 V AC -20 % ... +15 % 2x 400 V AC ... 500 V AC -10 % ... +15 %
Input voltage range	3x 320 V AC ... 575 V AC 2x 360 V AC ... 575 V AC
Frequency range	50 Hz ... 60 Hz
Current consumption (nominal load)	3x 0.4 A (400 V AC) / 3x 0.3 A (500 V AC) 2x 0.6 A (400 V AC) / 2x 0.5 A (500 V AC)
Inrush current limitation at 25°C / I <sub>t</sub>	≤ 22 A / ≤ 0.25 A <sup>2</sup> s
Mains buffering (I <sub>n</sub> , typ.)	> 20 ms (400 V AC) / > 20 ms (500 V AC)
Output data	
Nominal output voltage	24 V DC ±1 %
Setting range of the output voltage (U <sub>set</sub> )	24 V DC ... 28 V DC (> 24 V DC, constant capacity restricted)
Output current / Dynamic Boost (5 s)	5 A / 7.5 A
Can be connected in parallel/series	yes, with redundancy module / yes
Max. power dissipation (no load/nominal load)	< 1 W / < 12 W
Efficiency	> 91 % (at 400 V AC and nominal values)
Residual ripple	≤ 20 mV <sub>pp</sub>
Signaling	
Signaling DC OK	LED, floating signal contact
General data	
Weight / Dimensions W x H x D	0.4 kg / 35 x 130 x 115 mm
Assembly instructions	Can be aligned: Horizontally 0 mm (≤ 40 °C) 10 mm (≤ 70 °C), vertically 50 mm
Connection method	Push-in connection
Input connection data (solid/stranded/AWG)	0.2 - 4 mm <sup>2</sup> / 0.2 - 2.5 mm <sup>2</sup> / 24 - 12
Output connection data (solid/stranded/AWG)	0.2 - 4 mm <sup>2</sup> / 0.2 - 2.5 mm <sup>2</sup> / 24 - 12
Degree of protection / Protection class	IP20 / II
MTBF (IEC 61709, SN 29500)	> 1300000 h (40°C)
Ambient temperature (operation)	-25 °C ... 70 °C (> 60 °C derating: 2.5%/K)
Standards/regulations	
Insulation voltage input/output	1.5 kV AC (routine test) / 3 kV AC (type test)
Electromagnetic compatibility	Conformance with EMC Directive 2014/30/EU
Electrical safety	IEC 60950-1/VDE 0805 (SELV)
Electronic equipm. for electrical power installations	EN 50178/VDE 0160 (PELV)
Safe isolation	DIN VDE 0100-410
UL approvals	UL Listed UL 508 , UL/C-UL Recognized UL 60950-1
Limitation of harmonic line currents	EN 61000-3-2

#### Ordering data

Description	Type	Order No.	Pcs./Pkt.
Power supply, primary-switched	TRIO-PS-2G/3AC/24DC/5	2903153	1

new



**Power supply,  
3 AC, 24 V DC, 10 A**



**Power supply,  
3 AC, 24 V DC, 20 A**



**Power supply,  
3 AC, 24 V DC, 40 A**

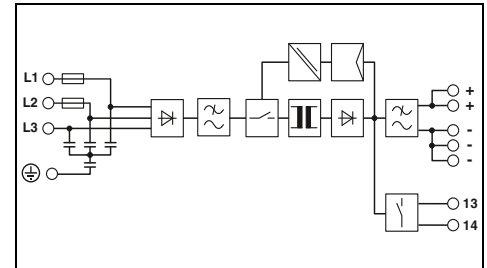
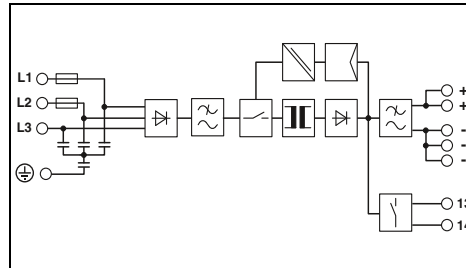
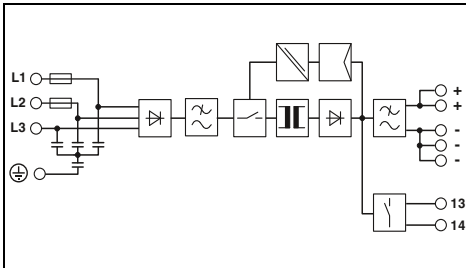

### Technical data

3x 400 V AC ... 500 V AC -20 % ... +15 %  
2x 400 V AC ... 500 V AC -10 % ... +15 %  
3x 320 V AC ... 575 V AC  
2x 360 V AC ... 575 V AC  
50 Hz ... 60 Hz  
3x 0.6 A (400 V AC) / 3x 0.6 A (500 V AC)  
2x 1.1 A (400 V AC) / 2x 1.1 A (500 V AC)  
≤ 26 A / 0.3 A<sup>2</sup>s  
> 10 ms (400 V AC) / > 20 ms (500 V AC)

24 V DC ±1 %  
24 V DC ... 28 V DC (> 24 V DC, constant capacity restricted)

10 A / 15 A  
yes, with redundancy module / yes  
< 1.1 W / < 22 W  
> 92 % (at 400 V AC and nominal values)  
≤ 20 mV<sub>pp</sub>

LED, floating signal contact

0.9 kg / 42 x 130 x 160 mm  
Can be aligned: Horizontally 0 mm (≤ 40 °C) 10 mm (≤ 70 °C), vertically 50 mm  
Push-in connection  
0.2 - 4 mm<sup>2</sup> / 0.2 - 2.5 mm<sup>2</sup> / 24 - 12  
0.2 - 4 mm<sup>2</sup> / 0.2 - 2.5 mm<sup>2</sup> / 24 - 12  
IP20 / I  
> 1200000 h (40 °C)  
-25 °C ... 70 °C (> 60 °C derating: 2.5%/K)

1.5 kV AC (routine test) / 3 kV AC (type test)  
Conformance with EMC Directive 2014/30/EU  
IEC 60950-1/VDE 0805 (SELV)  
EN 50178/VDE 0160 (PELV)  
DIN VDE 0100-410  
UL Listed UL 508 , UL/C-UL Recognized UL 60950-1  
EN 61000-3-2

### Technical data

3x 400 V AC ... 500 V AC -20 % ... +15 %  
2x 400 V AC ... 500 V AC -10 % ... +15 %  
3x 320 V AC ... 575 V AC  
2x 360 V AC ... 575 V AC  
50 Hz ... 60 Hz  
3x 1.2 A (400 V AC) / 3x 1 A (500 V AC)  
2x 2.3 A (400 V AC) / 2x 1.9 A (500 V AC)  
≤ 22 A / 0.5 A<sup>2</sup>s  
> 10 ms (400 V AC) / > 20 ms (500 V AC)

24 V DC ±1 %  
24 V DC ... 28 V DC (> 24 V DC, constant capacity restricted)

20 A / 30 A  
yes, with redundancy module / yes  
< 1.2 W / < 38 W  
> 93 % (at 400 V AC and nominal values)  
≤ 20 mV<sub>pp</sub>

LED, floating signal contact

1.5 kg / 65 x 130 x 160 mm  
Can be aligned: Horizontally 0 mm (≤ 40 °C) 10 mm (≤ 70 °C), vertically 50 mm  
Push-in connection  
0.2 - 4 mm<sup>2</sup> / 0.2 - 2.5 mm<sup>2</sup> / 24 - 12  
0.2 - 10 mm<sup>2</sup> / 0.2 - 6 mm<sup>2</sup> / 24 - 8  
IP20 / I  
> 1100000 h (40 °C)  
-25 °C ... 70 °C (> 60 °C derating: 2.5%/K)

1.5 kV AC (routine test) / 3 kV AC (type test)  
Conformance with EMC Directive 2014/30/EU  
IEC 60950-1/VDE 0805 (SELV)  
EN 50178/VDE 0160 (PELV)  
DIN VDE 0100-410  
UL Listed UL 508 , UL/C-UL Recognized UL 60950-1  
EN 61000-3-2

### Technical data

3x 400 V AC ... 500 V AC  
3x 320 V AC ... 575 V AC  
50 Hz ... 60 Hz  
3x 2 A (400 V AC) / 3x 1.6 A (500 V AC)  
3x 1.65 A (480 V AC)  
≤ 30 A / 1.1 A<sup>2</sup>s  
> 10 ms (400 V AC) / > 20 ms (500 V AC)

24 V DC ±1 %  
24 V DC ... 28 V DC (> 24 V DC, constant capacity restricted)

40 A / 60 A  
yes, with redundancy module / yes  
< 14 W / < 68 W  
> 93 % (at 400 V AC and nominal values)  
≤ 50 mV<sub>pp</sub>

LED, floating signal contact

2.6 kg / 110 x 130 x 160 mm  
Can be aligned: Horizontally 0 mm (≤ 40 °C) 10 mm (≤ 70 °C), vertically 50 mm  
Push-in connection  
0.2 - 4 mm<sup>2</sup> / 0.2 - 2.5 mm<sup>2</sup> / 24 - 12  
0.75 - 16 mm<sup>2</sup> / 0.75 - 10 mm<sup>2</sup> / 20 - 4  
IP20 / I  
> 1051000 h (40 °C)  
-25 °C ... 70 °C (> 60 °C derating: 2.5%/K)

1.5 kV AC (routine test) / 3 kV AC (type test)  
Conformance with EMC Directive 2014/30/EU  
IEC 60950-1/VDE 0805 (SELV)  
EN 50178/VDE 0160 (PELV)  
DIN VDE 0100-410  
UL Listed UL 508 , UL/C-UL Recognized UL 60950-1  
EN 61000-3-2

### Ordering data

Type	Order No.	Pcs./Pkt.
TRIO-PS-2G/3AC/24DC/10	2903154	1

### Ordering data

Type	Order No.	Pcs./Pkt.
TRIO-PS-2G/3AC/24DC/20	2903155	1

### Ordering data

Type	Order No.	Pcs./Pkt.
TRIO-PS-2G/3AC/24DC/40	2903156	1

## Power supplies

### TRIO POWER power supplies – robust standard functionality

#### TRIO POWER 1 AC, 12 and 48 V DC

- High operational reliability thanks to the robust design
- Wide temperature range from -25°C to +70°C as well as device startup at -40°C (type-tested)
- Reliable starting of dynamic loads with the dynamic boost, which supplies up to 1.5 times the nominal current for 5 seconds
- Time savings during installation, thanks to the use of tool-free Push-in connection technology
- Space savings in the control cabinet thanks to the narrow design
- Active function monitoring with DC OK LED and relay contact
- Input voltage range for DC voltage of 110 ... 250 V DC
- Third negative terminal block for grounding on the secondary side
- Maximum availability thanks to high MTBF (mean time between failure)
- Compensation of voltage drops by means of output voltage that can be set on the front

#### TRIO POWER, NEC Class 2

Output power limited to 100 W

- Specifically for applications that require certification according to UL 1310/508 Listed Class 2



new

Power supply,  
1 AC, 12 V DC, 5 A  
NEC Class 2

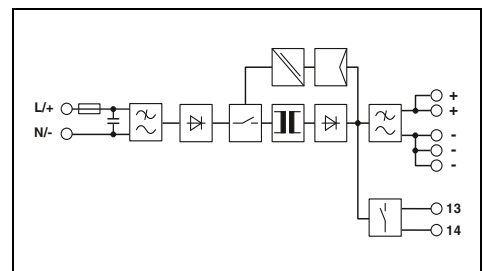

Technical data	
Input data	
Nominal input voltage range	100 V AC ... 240 V AC -15 % ... +10 % 110 V DC ... 250 V DC
Input voltage range	85 V AC ... 264 V AC 99 V DC ... 275 V DC
Frequency range	50 Hz ... 60 Hz
Current consumption (nominal load)	1.1 A (100 V AC) / 0.6 A (240 V AC) 0.7 A (110 V DC) / 0.3 A (250 V DC)
Inrush current limitation at 25°C / I <sub>tr</sub>	≤ 25 A / ≤ 0.6 A <sup>2</sup> s
Mains buffering (I <sub>tr</sub> , typ.)	> 20 ms (120 V AC) / > 110 ms (230 V AC)
Output data	
Nominal output voltage	12 V DC ±1 %
Setting range of the output voltage (U <sub>set</sub> )	12 V DC ... 18 V DC (> 12 V DC, constant capacity restricted)
Output current / Dynamic Boost (5 s)	5 A / -
Can be connected in parallel/series	yes, with redundancy module / yes
Max. power dissipation (no load/nominal load)	< 1 W (230 V) / < 10 W (230 V)
Efficiency	> 86 % (for 230 V AC and nominal values)
Residual ripple	≤ 50 mV <sub>pp</sub>
Signaling	
Signaling DC OK	LED, floating signal contact
General data	
Weight / Dimensions W x H x D	0.32 kg / 30 x 130 x 115 mm
Assembly instructions	Can be aligned: Horizontally 0 mm (≤ 40 °C) 10 mm (≤ 70 °C), vertically 50 mm
Connection method	Push-in connection
Input connection data (solid/stranded/AWG)	0.2 - 4 mm <sup>2</sup> / 0.2 - 2.5 mm <sup>2</sup> / 24 - 12
Output connection data (solid/stranded/AWG)	0.2 - 4 mm <sup>2</sup> / 0.2 - 2.5 mm <sup>2</sup> / 24 - 12
Degree of protection / Protection class	IP20 / II
MTBF (IEC 61709, SN 29500)	> 2900000 h (40°C)
Ambient temperature (operation)	-25 °C ... 70 °C (> 60 °C derating: 2.5%/K)
Standards/regulations	
Insulation voltage input/output	1.5 kV AC (routine test) / 3 kV AC (type test)
Electromagnetic compatibility	Conformance with EMC Directive 2014/30/EU
Electrical safety	IEC 60950-1/VDE 0805 (SELV)
Electronic equipm. for electrical power installations	EN 50178/VDE 0160 (PELV)
Safe isolation	DIN VDE 0100-410
UL approvals	UL Listed UL 508, UL/C-UL Recognized UL 60950-1, NEC Class 2 as per UL 1310
Limitation of harmonic line currents	EN 61000-3-2

Ordering data		
Type	Order No.	Pcs./Pkt.
TRIO-PS-2G/1AC/12DC/5/C2LPS	2903157	1

Description
Power supply, primary-switched



new

Power supply,  
1 AC, 12 V DC, 10 A

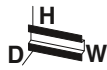

new

Power supply,  
1 AC, 48 V DC, 5 A



new

Power supply,  
1 AC, 48 V DC, 10 A

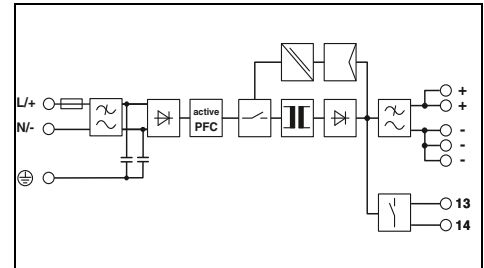
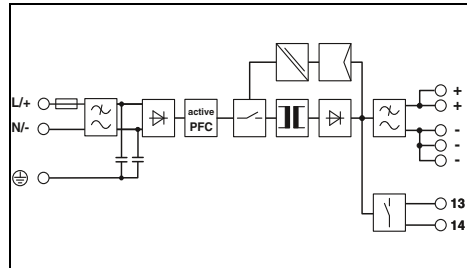
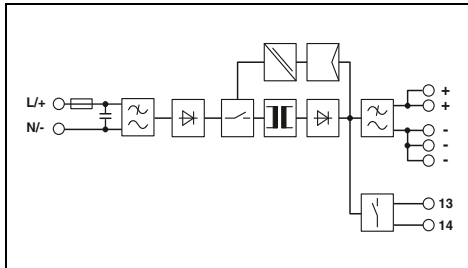

Technical data

100 V AC ... 240 V AC -15 % ... +10 %  
110 V DC ... 250 V DC  
85 V AC ... 264 V AC  
99 V DC ... 275 V DC  
50 Hz ... 60 Hz  
2.2 A (100 V AC) / 1.1 A (240 V AC)  
1.4 A (110 V DC) / 0.6 A (250 V DC)  
≤ 30 A / ≤ 1.5 A<sup>2</sup>s  
> 20 ms (120 V AC) / > 20 ms (230 V AC)

12 V DC ±1 %  
12 V DC ... 18 V DC (> 12 V DC, constant capacity restricted)

10 A / 15 A  
yes, with redundancy module / yes  
< 1 W (230 V) / < 15 W (230 V)  
> 89 % (for 230 V AC and nominal values)  
≤ 50 mV<sub>pp</sub>

LED, floating signal contact

0.4 kg / 35 x 130 x 115 mm  
Can be aligned: Horizontally 0 mm (≤ 40 °C) 10 mm (≤ 70 °C), vertically 50 mm  
Push-in connection  
0.2 - 4 mm<sup>2</sup> / 0.2 - 2.5 mm<sup>2</sup> / 24 - 12  
0.2 - 4 mm<sup>2</sup> / 0.2 - 2.5 mm<sup>2</sup> / 24 - 12  
IP20 / II  
> 1700000 h (40 °C)  
-25 °C ... 70 °C (> 60 °C derating: 2.5%/K)

1.5 kV AC (routine test) / 3 kV AC (type test)  
Conformance with EMC Directive 2014/30/EU  
IEC 60950-1/VDE 0805 (SELV)  
EN 50178/VDE 0160 (PELV)  
DIN VDE 0100-410  
UL Listed UL 508 , UL/C-UL Recognized UL 60950-1

EN 61000-3-2

Technical data

100 V AC ... 240 V AC -15 % ... +10 %  
110 V DC ... 250 V DC  
85 V AC ... 264 V AC  
99 V DC ... 275 V DC  
50 Hz ... 60 Hz  
2.9 A (100 V AC) / 1.2 A (240 V AC)  
2.4 A (110 V DC) / 1 A (250 V DC)  
15 A / 0.3 A<sup>2</sup>s  
> 15 ms (120 V AC) / > 15 ms (230 V AC)

48 V DC ±1 %  
36 V DC ... 55 V DC (> 48 V DC, constant capacity restricted)

5 A / 7.5 A  
yes, with redundancy module / yes  
< 3.5 W (230 V) / < 20 W  
> 92.4 % (for 230 V AC and nominal values)  
< 50 mV<sub>pp</sub>

LED, floating signal contact

0.9 kg / 42 x 130 x 160 mm  
Can be aligned: Horizontally 0 mm (≤ 40 °C) 10 mm (≤ 70 °C), vertically 50 mm  
Push-in connection  
0.2 - 4 mm<sup>2</sup> / 0.2 - 2.5 mm<sup>2</sup> / 24 - 12  
0.2 - 4 mm<sup>2</sup> / 0.2 - 2.5 mm<sup>2</sup> / 24 - 12  
IP20 / I  
> 1200000 h (40 °C)  
-25 °C ... 70 °C (> 60 °C derating: 2.5%/K)

1.5 kV AC / 3 kV AC  
Conformance with EMC Directive 2014/30/EU  
IEC 60950-1/VDE 0805 (SELV)  
EN 50178/VDE 0160 (PELV)  
DIN VDE 0100-410  
UL Listed UL 508 , UL/C-UL Recognized UL 60950-1

EN 61000-3-2

Technical data

100 V AC ... 240 V AC -15 % ... +10 %  
110 V DC ... 250 V DC  
85 V AC ... 264 V AC  
99 V DC ... 275 V DC  
50 Hz ... 60 Hz  
5.6 A (100 V AC) / 2.4 A (240 V AC)  
5 A (110 V DC) / 2.2 A (250 V DC)  
20 A / 0.7 A<sup>2</sup>s  
> 10 ms (120 V AC) / > 15 ms (230 V AC)

48 V DC ±1 %  
36 V DC ... 55 V DC (> 48 V DC, constant capacity restricted)

10 A / 15 A  
yes, with redundancy module / yes  
< 5.7 W (230 V) / < 44 W  
> 93 % (for 230 V AC and nominal values)  
< 50 mV<sub>pp</sub>

LED, floating signal contact

1.4 kg / 68 x 130 x 160 mm  
Can be aligned: Horizontally 0 mm (≤ 40 °C) 10 mm (≤ 70 °C), vertically 50 mm  
Push-in connection  
0.2 - 4 mm<sup>2</sup> / 0.2 - 2.5 mm<sup>2</sup> / 24 - 12  
0.2 - 10 mm<sup>2</sup> / 0.2 - 6 mm<sup>2</sup> / 24 - 8  
IP20 / I  
> 800000 h (40 °C)  
-25 °C ... 70 °C (> 60 °C derating: 2.5%/K)

1.5 kV AC / 3 kV AC  
Conformance with EMC Directive 2014/30/EU  
IEC 60950-1/VDE 0805 (SELV)  
EN 50178/VDE 0160 (PELV)  
DIN VDE 0100-410  
UL Listed UL 508 , UL/C-UL Recognized UL 60950-1

EN 61000-3-2

Ordering data

Type	Order No.	Pcs./Pkt.
TRIO-PS-2G/1AC/12DC/10	2903158	1

Ordering data

Type	Order No.	Pcs./Pkt.
TRIO-PS-2G/1AC/48DC/5	2903159	1

Ordering data

Type	Order No.	Pcs./Pkt.
TRIO-PS-2G/1AC/48DC/10	2903160	1

# Power supplies and UPS

## Power supplies

### UNO POWER power supplies – compact basic functionality

#### UNO POWER, 1 AC, 24 V DC

- The wide range of products covers all common voltage levels
- Maximum energy efficiency: save energy thanks to high efficiency and extremely low idling losses
- Save space in the control cabinet thanks to extremely high power density
- Housing depth of 84 mm, tailored to all popular 120 mm control boxes
- Wide temperature range from -25°C to +70°C



Power supply,  
1 AC, 24 DC, 30 W  
NEC Class 2



Power supply,  
1 AC, 24 DC, 60 W  
NEC Class 2

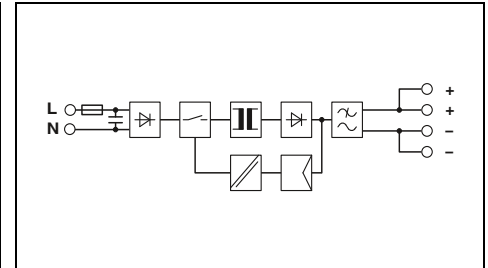
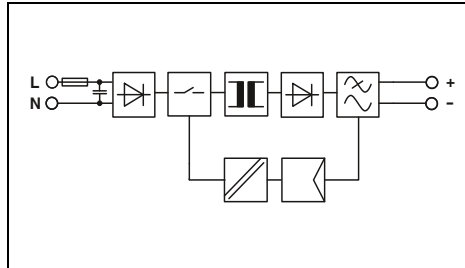

#### Technical data

Input data
Nominal input voltage range
Input voltage range
Frequency range
Current consumption (nominal load)
Inrush current limitation at 25°C / I <sup>2</sup> t
Mains buffering (I <sub>N</sub> , typ.)
Output data
Nominal output voltage
Output current
Can be connected in parallel/series
Max. power dissipation (no load/nominal load)
Efficiency
Residual ripple
Signaling
Signaling DC OK
General data
Weight / Dimensions W x H x D
Assembly instructions
Connection method
Connection data solid/stranded/AWG
Degree of protection / Protection class
MTBF (IEC 61709, SN 29500)
Ambient temperature (operation)
Standards/regulations
Insulation voltage input/output
Electromagnetic compatibility
Electrical safety
Electronic equipm. for electrical power installations
Safe isolation
UL approvals
Limitation of harmonic line currents

100 V AC ... 240 V AC
85 V AC ... 264 V AC
45 Hz ... 65 Hz
0.5 A (120 V AC) / 0.3 A (230 V AC)
< 20 A / < 0.4 A <sup>2</sup> s
> 25 ms (120 V AC) / > 115 ms (230 V AC)
24 V DC ±1 %
1.25 A
yes, with redundancy module / yes
< 0.3 W / < 5 W
> 88 % (for 230 V AC and nominal values)
< 60 mV <sub>pp</sub>
LED
0.15 kg / 22.5 x 90 x 84 mm
Alignable: 0 mm horizontally, 30 mm vertically
Screw connection
0.2 - 2.5 mm <sup>2</sup> / 0.2 - 2.5 mm <sup>2</sup> / 24 - 14
IP20 / II
> 1158000 h (40°C)
-25 °C ... 70 °C (> 55° C derating: 2.5%/K)
3 kV AC (routine test) / 4 kV AC (type test)
Conformance with EMC Directive 2014/30/EU
IEC 60950-1/VDE 0805 (SELV)
EN 50178/VDE 0160 (PELV)
DIN VDE 0100-410
UL/C-UL listed UL 508 , UL/C-UL Recognized UL 60950 , NEC Class 2 as per UL 1310
EN 61000-3-2

#### Ordering data

Description
Power supply, primary-switched

Type	Order No.	Pcs./Pkt.
UNO-PS/1AC/24DC/ 30W	2902991	1

#### Technical data

100 V AC ... 240 V AC
85 V AC ... 264 V AC
45 Hz ... 65 Hz
1 A (120 V AC) / 0.6 A (230 V AC)
< 30 A / < 0.5 A <sup>2</sup> s
> 20 ms (120 V AC) / > 85 ms (230 V AC)
24 V DC ±1 %
2.5 A
yes, with redundancy module / yes
< 0.3 W / < 7 W
> 90 % (for 230 V AC and nominal values)
< 30 mV <sub>pp</sub>
LED
0.2 kg / 35 x 90 x 84 mm
Alignable: 0 mm horizontally, 30 mm vertically
Screw connection
0.2 - 2.5 mm <sup>2</sup> / 0.2 - 2.5 mm <sup>2</sup> / 24 - 14
IP20 / II
> 785000 h (40°C)
-25 °C ... 70 °C (> 55° C derating: 2.5%/K)
3 kV AC (routine test) / 4 kV AC (type test)
Conformance with EMC Directive 2014/30/EU
IEC 60950-1/VDE 0805 (SELV)
EN 50178/VDE 0160 (PELV)
DIN VDE 0100-410
UL Listed UL 508 , UL/C-UL Recognized UL 60950 , NEC Class 2 as per UL 1310 , UL ANSI/ISA-12.12.01 Class I, Division 2, Groups A, B, C, D T4A (Hazardous Location)
EN 61000-3-2

#### Ordering data

Type	Order No.	Pcs./Pkt.
UNO-PS/1AC/24DC/ 60W	2902992	1



Power supply,  
1 AC, 24 DC, 100 W



Power supply,  
1 AC, 24 DC, 150 W



Power supply,  
1 AC, 24 DC, 240 W

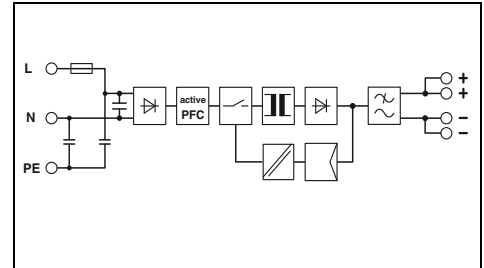
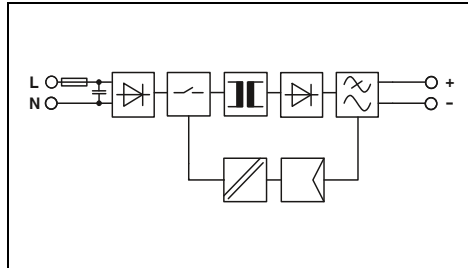
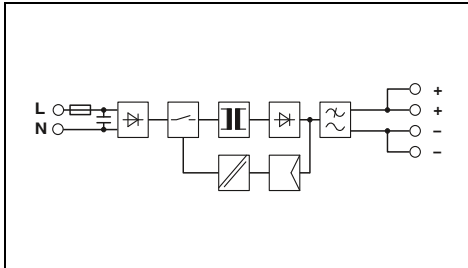

Technical data

100 V AC ... 240 V AC  
85 V AC ... 264 V AC  
45 Hz ... 65 Hz  
1.7 A (120 V AC) / 1 A (230 V AC)  
< 40 A / < 1.5 A<sup>2</sup>s  
> 20 ms (120 V AC) / > 100 ms (230 V AC)

24 V DC ±1 %  
4.2 A  
yes, with redundancy module / yes  
< 0.5 W / < 11 W  
> 90 % (for 230 V AC and nominal values)  
< 30 mV<sub>pp</sub>

LED

0.34 kg / 55 x 90 x 84 mm  
Alignable: 0 mm horizontally, 30 mm vertically  
Screw connection  
0.2 - 2.5 mm<sup>2</sup> / 0.2 - 2.5 mm<sup>2</sup> / 24 - 14  
IP20 / II  
> 738000 h (40°C)  
-25 °C ... 70 °C (> 55 °C derating: 2.5%/K)

3 kV AC (routine test) / 4 kV AC (type test)  
Conformance with EMC Directive 2014/30/EU  
IEC 60950-1/VDE 0805 (SELV)  
EN 50178/VDE 0160 (PELV)  
DIN VDE 0100-410  
UL Listed UL 508 , UL/C-UL Recognized UL 60950 ,  
UL ANSI/ISA-12.12.01 Class I, Division 2, Groups A, B, C, D T4  
(Hazardous Location)  
EN 61000-3-2

Ordering data

Type	Order No.	Pcs./Pkt.
UNO-PS/1AC/24DC/100W	2902993	1

Technical data

100 V AC ... 240 V AC  
85 V AC ... 264 V AC  
45 Hz ... 65 Hz  
1.4 A (120 V AC) / 0.8 A (230 V AC)  
< 50 A / < 0.8 A<sup>2</sup>s  
> 20 ms (120 V AC) / > 20 ms (230 V AC)

24 V DC ±1 %  
6.25 A  
yes, with redundancy module / No  
< 1.2 W / < 9.7 W  
> 94 % (for 230 V AC and nominal values)  
< 40 mV<sub>pp</sub>

LED

0.5 kg / 37 x 130 x 125 mm  
Alignable: 0 mm horizontally, 30 mm vertically  
Screw connection  
0.2 - 2.5 mm<sup>2</sup> / 0.2 - 2.5 mm<sup>2</sup> / 24 - 14  
IP20 / II  
> 868000 h (40°C)  
-25 °C ... 70 °C (> 55 °C derating: 2.5%/K)

3 kV AC (routine test) / 4 kV AC (type test)  
Conformance with EMC Directive 2014/30/EU  
EN 60950-1/VDE 0805 (SELV)  
EN 50178/VDE 0160 (PELV)  
DIN VDE 0100-410  
UL Listed UL 508 , UL/C-UL Recognized UL 60950 ,  
UL ANSI/ISA-12.12.01 Class I, Division 2, Groups A, B, C, D T4  
(Hazardous Location)  
EN 61000-3-2

Ordering data

Type	Order No.	Pcs./Pkt.
UNO-PS/1AC/24DC/150W	2904376	1

Technical data

100 V AC ... 240 V AC  
85 V AC ... 264 V AC  
45 Hz ... 65 Hz  
2.3 A (120 V AC) / 1.2 A (230 V AC)  
< 80 A / < 2 A<sup>2</sup>s  
> 10 ms (120 V AC) / > 10 ms (230 V AC)

24 V DC ±1 %  
10 A  
yes, with redundancy module / No  
< 1.1 W / < 18.8 W  
> 93 % (for 230 V AC and nominal values)  
< 50 mV<sub>pp</sub>

LED

0.66 kg / 45 x 130 x 125 mm  
Alignable: 0 mm horizontally, 30 mm vertically  
Screw connection  
0.2 - 2.5 mm<sup>2</sup> / 0.2 - 2.5 mm<sup>2</sup> / 24 - 14  
IP20 / I  
> 562000 h (40°C)  
-25 °C ... 70 °C (> 55 °C derating: 2.5%/K)

3 kV AC (routine test) / 4 kV AC (type test)  
Conformance with EMC Directive 2014/30/EU  
EN 60950-1/VDE 0805 (SELV)  
EN 50178/VDE 0160 (PELV)  
DIN VDE 0100-410  
UL Listed UL 508 , UL/C-UL Recognized UL 60950 ,  
UL ANSI/ISA-12.12.01 Class I, Division 2, Groups A, B, C, D T4  
(Hazardous Location)  
EN 61000-3-2

Ordering data

Type	Order No.	Pcs./Pkt.
UNO-PS/1AC/24DC/240W	2904372	1

# Power supplies and UPS

## Power supplies

### UNO POWER power supplies – compact basic functionality

#### UNO POWER, 1 AC, 12 and 24 V DC

- The wide range of products covers all common voltage levels
- Maximum energy efficiency: save energy thanks to high efficiency and extremely low idling losses
- Save space in the control cabinet thanks to extremely high power density
- Housing depth of 84 mm, tailored to all popular 120 mm control boxes
- Wide temperature range from -25°C to +70°C



Power supply,  
1 AC, 24 DC, 90 W  
NEC Class 2



Power supply,  
2 AC, 24 DC, 90 W  
NEC Class 2



#### UNO POWER, 2 AC, 24 V DC, NEC Class 2

Output power limited to 100 W

- Specifically for applications that require certification according to UL 1310/508 Listed Class 2

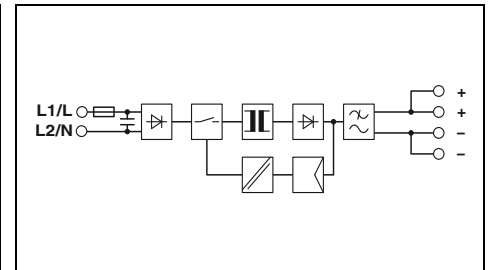
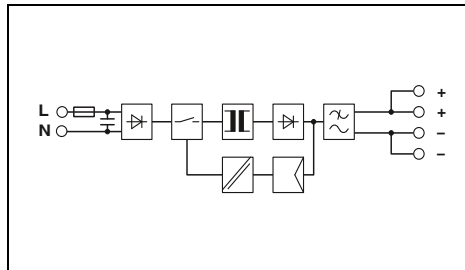

#### Technical data

Input data
Nominal input voltage range
Input voltage range
Frequency range
Current consumption (nominal load)
Inrush current limitation at 25°C / I <sub>pt</sub>
Mains buffering (I <sub>N</sub> , typ.)
Output data
Nominal output voltage
Output current
Can be connected in parallel/series
Max. power dissipation (no load/nominal load)
Efficiency
Residual ripple
Signaling
Signaling DC OK
General data
Weight / Dimensions W x H x D
Assembly instructions
Connection method
Connection data solid/stranded/AWG
Degree of protection / Protection class
MTBF (IEC 61709, SN 29500)
Ambient temperature (operation)
Standards/regulations
Insulation voltage input/output
Electromagnetic compatibility
Electrical safety
Electronic equipm. for electrical power installations
Safe isolation
UL approvals
Limitation of harmonic line currents

100 V AC ... 240 V AC
85 V AC ... 264 V AC
45 Hz ... 65 Hz
1.5 A (120 V AC) / 1 A (230 V AC)
< 40 A / < 1.5 A <sup>2</sup> s
> 25 ms (120 V AC) / > 100 ms (230 V AC)
24 V DC ±1 %
3.75 A
No / No
< 0.5 W / < 12 W
> 88.5 % (for 230 V AC and nominal values)
< 45 mV <sub>pp</sub>
LED
0.34 kg / 55 x 90 x 84 mm
Alignable: 0 mm horizontally, 30 mm vertically
Screw connection
0.2 - 2.5 mm <sup>2</sup> / 0.2 - 2.5 mm <sup>2</sup> / 24 - 14
IP20 / II
> 1159000 h (40°C)
-25 °C ... 70 °C (> 55° C derating: 2.5%/K)
3 kV AC (routine test) / 4 kV AC (type test)
Conformance with EMC Directive 2014/30/EU
IEC 60950-1/VDE 0805 (SELV)
EN 50178/VDE 0160 (PELV)
DIN VDE 0100-410
UL/C-UL listed UL 508 , UL/C-UL Recognized UL 60950 ,
NEC Class 2 as per UL 1310 , UL ANSI/ISA-12.12.01 Class I,
Division 2, Groups A, B, C, D T4 (Hazardous Location)
EN 61000-3-2

#### Ordering data

Description
Power supply, primary-switched

Type	Order No.	Pcs./Pkt.
UNO-PS/1AC/24DC/90W/C2LPS	2902994	1

#### Technical data

2x 400 V AC ... 500 V AC
2x 264 V AC ... 575 V AC
45 Hz ... 65 Hz
0.6 A (400 V AC) / 0.5 A (500 V AC)
< 30 A / < 0.5 A <sup>2</sup> s
> 65 ms (400 V AC) / > 100 ms (500 V AC)
24 V DC ±1 %
3.75 A
No / No
< 0.7 W / < 12 W
> 89.5 %
< 50 mV <sub>pp</sub>
LED
0.32 kg / 55 x 90 x 84 mm
Alignable: 0 mm horizontally, 30 mm vertically
Screw connection
0.2 - 2.5 mm <sup>2</sup> / 0.2 - 2.5 mm <sup>2</sup> / 24 - 14
IP20 / II
> 828000 h (40°C)
-25 °C ... 70 °C (> 55° C derating: 2.5%/K)
3 kV AC (routine test) / 4 kV AC (type test)
Conformance with EMC Directive 2014/30/EU
IEC 60950-1/VDE 0805 (SELV)
EN 50178/VDE 0160 (PELV)
DIN VDE 0100-410
UL/C-UL listed UL 508 , UL/C-UL Recognized UL 60950 ,
NEC Class 2 as per UL 1310 , UL ANSI/ISA-12.12.01 Class I,
Division 2, Groups A, B, C, D T4 (Hazardous Location)
EN 61000-3-2

#### Ordering data

Type	Order No.	Pcs./Pkt.
UNO-PS/2AC/24DC/90W/C2LPS	2904371	1



Power supply,  
1 AC, 12 DC, 30 W



Power supply,  
1 AC, 12 DC, 55 W



Power supply,  
1 AC, 12 DC, 100 W

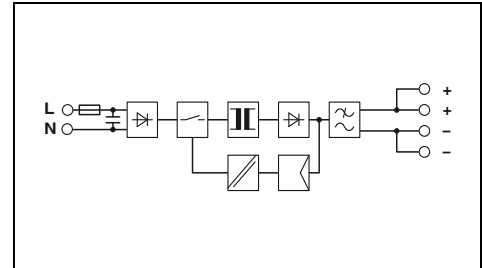
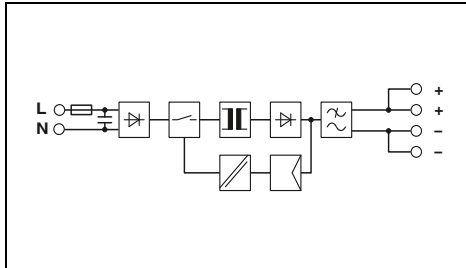
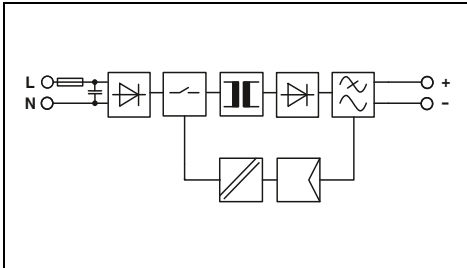

Technical data

100 V AC ... 240 V AC  
85 V AC ... 264 V AC  
45 Hz ... 65 Hz  
0.5 A (120 V AC) / 0.3 A (230 V AC)  
< 25 A / < 0.3 A<sup>2</sup>s  
> 20 ms (120 V AC) / > 110 ms (230 V AC)

12 V DC ±1 %  
2.5 A  
yes, with redundancy module / yes  
< 0.3 W / < 4.6 W  
> 87 % (for 230 V AC and nominal values)  
< 30 mV<sub>pp</sub>

LED

0.15 kg / 22.5 x 90 x 84 mm  
Alignable: 0 mm horizontally, 30 mm vertically  
Screw connection  
0.2 - 2.5 mm<sup>2</sup> / 0.2 - 2.5 mm<sup>2</sup> / 24 - 14  
IP20 / II  
> 953000 h (40°C)  
-25 °C ... 70 °C (> 55° C derating: 2.5%/K)

3 kV AC (routine test) / 4 kV AC (type test)  
Conformance with EMC Directive 2014/30/EU  
IEC 60950-1/VDE 0805 (SELV)  
EN 50178/VDE 0160 (PELV)  
DIN VDE 0100-410  
UL Listed UL 508 , UL/C-UL Recognized UL 60950 ,  
UL ANSI/ISA-12.12.01 Class I, Division 2, Groups A, B, C, D T4  
(Hazardous Location)  
EN 61000-3-2

Ordering data

Type	Order No.	Pcs./Pkt.
UNO-PS/1AC/12DC/ 30W	2902998	1

Technical data

100 V AC ... 240 V AC  
85 V AC ... 264 V AC  
45 Hz ... 65 Hz  
1 A (120 V AC) / 0.6 A (230 V AC)  
< 30 A / < 0.5 A<sup>2</sup>s  
> 20 ms (120 V AC) / > 90 ms (230 V AC)

12 V DC ±1 %  
4.6 A  
yes, with redundancy module / yes  
< 0.3 W / < 8 W  
> 89 % (for 230 V AC and nominal values)  
< 30 mV<sub>pp</sub>

LED

0.2 kg / 35 x 90 x 84 mm  
Alignable: 0 mm horizontally, 30 mm vertically  
Screw connection  
0.2 - 2.5 mm<sup>2</sup> / 0.2 - 2.5 mm<sup>2</sup> / 24 - 14  
IP20 / II  
> 865000 h (40°C)  
-25 °C ... 70 °C (> 55° C derating: 2.5%/K)

3 kV AC (routine test) / 4 kV AC (type test)  
Conformance with EMC Directive 2014/30/EU  
IEC 60950-1/VDE 0805 (SELV)  
EN 50178/VDE 0160 (PELV)  
DIN VDE 0100-410  
UL Listed UL 508 , UL/C-UL Recognized UL 60950 ,  
UL ANSI/ISA-12.12.01 Class I, Division 2, Groups A, B, C, D T4A  
(Hazardous Location)  
EN 61000-3-2

Ordering data

Type	Order No.	Pcs./Pkt.
UNO-PS/1AC/12DC/ 55W	2902999	1

Technical data

100 V AC ... 240 V AC  
85 V AC ... 264 V AC  
45 Hz ... 65 Hz  
1.7 A (120 V AC) / 1 A (230 V AC)  
< 30 A / < 1.5 A<sup>2</sup>s  
> 20 ms (120 V AC) / > 85 ms (230 V AC)

12 V DC ±1 %  
8.3 A  
yes, with redundancy module / yes  
< 0.4 W / < 12 W  
> 89.5 %  
< 75 mV<sub>pp</sub>

LED

0.34 kg / 55 x 90 x 84 mm  
Alignable: 0 mm horizontally, 30 mm vertically  
Screw connection  
0.2 - 2.5 mm<sup>2</sup> / 0.2 - 2.5 mm<sup>2</sup> / 24 - 14  
IP20 / II  
> 500000 h (40°C)  
-25 °C ... 70 °C (> 55° C derating: 2.5%/K)

3 kV AC (routine test) / 4 kV AC (type test)  
Conformance with EMC Directive 2014/30/EU  
IEC 60950-1/VDE 0805 (SELV)  
EN 50178/VDE 0160 (PELV)  
DIN VDE 0100-410  
UL/C-UL listed UL 508 , UL/C-UL Recognized UL 60950 ,  
UL ANSI/ISA-12.12.01 Class I, Division 2, Groups A, B, C, D T4  
(Hazardous Location)  
EN 61000-3-2

Ordering data

Type	Order No.	Pcs./Pkt.
UNO-PS/1AC/12DC/100W	2902997	1

# Power supplies and UPS

## Power supplies

### UNO POWER power supplies – compact basic functionality

#### UNO POWER, 1 AC, 5 and 15 V DC

- The wide range of products covers all common voltage levels
- Maximum energy efficiency: save energy thanks to high efficiency and extremely low idling losses
- Save space in the control cabinet thanks to extremely high power density
- Housing depth of 84 mm, tailored to all popular 120 mm control boxes
- Wide temperature range from -25°C to +70°C



Power supply,  
1 AC, 5 DC, 25 W



Power supply,  
1 AC, 5 DC, 40 W

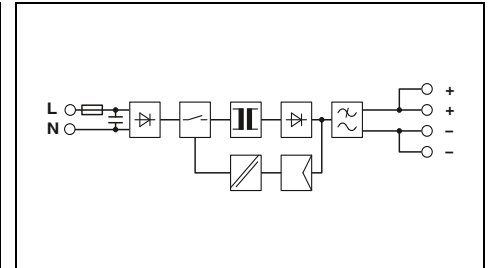
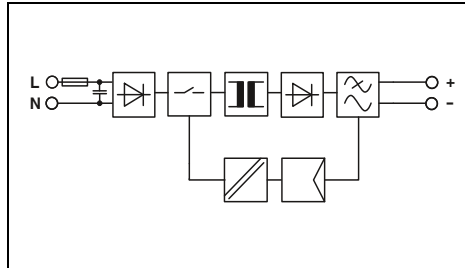

#### Technical data

Input data	
Nominal input voltage range	100 V AC ... 240 V AC
Input voltage range	85 V AC ... 264 V AC
Frequency range	45 Hz ... 65 Hz
Current consumption (nominal load)	0.5 A (120 V AC) / 0.3 A (230 V AC)
Inrush current limitation at 25°C / I²t	< 30 A / < 0.5 A²s
Mains buffering (I <sub>N</sub> , typ.)	> 35 ms (120 V AC) / > 135 ms (230 V AC)
Output data	
Nominal output voltage	5 V DC ±1 %
Output current	5 A
Can be connected in parallel/series	yes, with redundancy module / yes
Max. power dissipation (no load/nominal load)	< 0.3 W / < 4.5 W
Efficiency	> 84 %
Residual ripple	< 40 mV <sub>pp</sub>
Signaling	
Signaling DC OK	LED
General data	
Weight / Dimensions W x H x D	0.15 kg / 22.5 x 90 x 84 mm
Assembly instructions	Alignable: 0 mm horizontally, 30 mm vertically
Connection method	Screw connection
Connection data solid/stranded/AWG	0.2 - 2.5 mm² / 0.2 - 2.5 mm² / 24 - 14
Degree of protection / Protection class	IP20 / II
MTBF (IEC 61709, SN 29500)	> 2174000 h (40°C)
Ambient temperature (operation)	-25 °C ... 70 °C (> 55° C derating: 2.5%/K)
Standards/regulations	
Insulation voltage input/output	3 kV AC (routine test) / 4 kV AC (type test)
Electromagnetic compatibility	Conformance with EMC Directive 2014/30/EU
Electrical safety	IEC 60950-1/VDE 0805 (SELV)
Electronic equipm. for electrical power installations	EN 50178/VDE 0160 (PELV)
Safe isolation	DIN VDE 0100-410
UL approvals	UL/C-UL listed UL 508 , UL/C-UL Recognized UL 60950 , UL ANSI/ISA-12.12.01 Class I, Division 2, Groups A, B, C, D T4 (Hazardous Location)
Limitation of harmonic line currents	EN 61000-3-2

Technical data	
Nominal input voltage range	100 V AC ... 240 V AC
Input voltage range	85 V AC ... 264 V AC
Frequency range	45 Hz ... 65 Hz
Current consumption (nominal load)	0.7 A (120 V AC) / 0.5 A (230 V AC)
Inrush current limitation at 25°C / I²t	< 30 A / < 0.5 A²s
Mains buffering (I <sub>N</sub> , typ.)	> 30 ms (120 V AC) / > 120 ms (230 V AC)
Output data	
Nominal output voltage	5 V DC ±1 %
Output current	8 A
Can be connected in parallel/series	yes, with redundancy module / yes
Max. power dissipation (no load/nominal load)	< 0.3 W / < 7.5 W
Efficiency	> 85 % (for 230 V AC and nominal values)
Residual ripple	< 100 mV <sub>pp</sub>
Signaling	
Signaling DC OK	LED
General data	
Weight / Dimensions W x H x D	0.21 kg / 35 x 90 x 84 mm
Assembly instructions	Alignable: 0 mm horizontally, 30 mm vertically
Connection method	Screw connection
Connection data solid/stranded/AWG	0.2 - 2.5 mm² / 0.2 - 2.5 mm² / 24 - 14
Degree of protection / Protection class	IP20 / II
MTBF (IEC 61709, SN 29500)	> 1201000 h (40°C)
Ambient temperature (operation)	-25 °C ... 70 °C (> 55° C derating: 2.5%/K)
Standards/regulations	
Insulation voltage input/output	3 kV AC (routine test) / 4 kV AC (type test)
Electromagnetic compatibility	Conformance with EMC Directive 2014/30/EU
Electrical safety	IEC 60950-1/VDE 0805 (SELV)
Electronic equipm. for electrical power installations	EN 50178/VDE 0160 (PELV)
Safe isolation	DIN VDE 0100-410
UL approvals	UL/C-UL listed UL 508 , UL/C-UL Recognized UL 60950 , UL ANSI/ISA-12.12.01 Class I, Division 2, Groups A, B, C, D T4 (Hazardous Location)
Limitation of harmonic line currents	EN 61000-3-2

#### Ordering data

Description	Type	Order No.	Pcs./Pkt.
Power supply, primary-switched	UNO-PS/1AC/ 5DC/ 25W	2904374	1

#### Ordering data

Description	Type	Order No.	Pcs./Pkt.
Power supply, primary-switched	UNO-PS/1AC/ 5DC/ 40W	2904375	1



Power supply,  
1 AC, 15 DC, 30 W



Power supply,  
1 AC, 15 DC, 55 W



Power supply,  
1 AC, 15 DC, 100 W

UL US ENEC CB  
Ex:

UL US ENEC CB  
Ex:

UL US CB  
Ex:

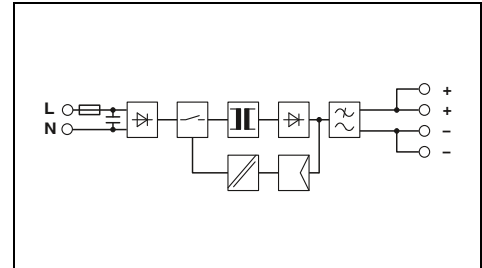
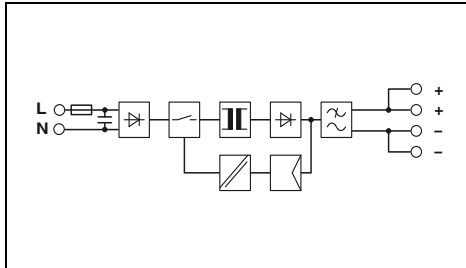
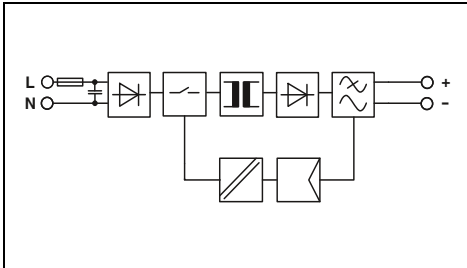

Technical data

100 V AC ... 240 V AC  
85 V AC ... 264 V AC  
45 Hz ... 65 Hz  
0.6 A (120 V AC) / 0.4 A (230 V AC)  
< 30 A / < 0.3 A<sup>2</sup>s  
> 20 ms (120 V AC) / > 115 ms (230 V AC)

15 V DC ±1 %  
2 A  
yes, with redundancy module / yes  
< 0.3 W / < 4.6 W  
> 87 % (for 230 V AC and nominal values)  
< 40 mV<sub>pp</sub>

LED

0.15 kg / 22.5 x 90 x 84 mm  
Alignable: 0 mm horizontally, 30 mm vertically  
Screw connection  
0.2 - 2.5 mm<sup>2</sup> / 0.2 - 2.5 mm<sup>2</sup> / 24 - 14  
IP20 / II  
> 911000 h (40°C)  
-25 °C ... 70 °C (> 55° C derating: 2.5%/K)

3 kV AC (routine test) / 4 kV AC (type test)  
Conformance with EMC Directive 2014/30/EU  
IEC 60950-1/VDE 0805 (SELV)  
EN 50178/VDE 0160 (PELV)  
DIN VDE 0100-410  
UL/C-UL listed UL 508 , UL/C-UL Recognized UL 60950 ,  
UL ANSI/ISA-12.12.01 Class I, Division 2, Groups A, B, C, D T4  
(Hazardous Location)  
EN 61000-3-2

Ordering data

Type	Order No.	Pcs./Pkt.
UNO-PS/1AC/15DC/30W	2903000	1

Technical data

100 V AC ... 240 V AC  
85 V AC ... 264 V AC  
45 Hz ... 65 Hz  
1 A (120 V AC) / 0.6 A (230 V AC)  
< 25 A / < 0.5 A<sup>2</sup>s  
> 25 ms (120 V AC) / > 90 ms (230 V AC)

15 V DC ±1 %  
3.7 A  
yes, with redundancy module / yes  
< 0.3 W / < 7 W  
> 88.5 % (for 230 V AC and nominal values)  
< 50 mV<sub>pp</sub>

LED

0.21 kg / 35 x 90 x 84 mm  
Alignable: 0 mm horizontally, 30 mm vertically  
Screw connection  
0.2 - 2.5 mm<sup>2</sup> / 0.2 - 2.5 mm<sup>2</sup> / 24 - 14  
IP20 / II  
> 647000 h (40°C)  
-25 °C ... 70 °C (> 55° C derating: 2.5%/K)

3 kV AC (routine test) / 4 kV AC (type test)  
Conformance with EMC Directive 2014/30/EU  
IEC 60950-1/VDE 0805 (SELV)  
EN 50178/VDE 0160 (PELV)  
DIN VDE 0100-410  
UL/C-UL listed UL 508 , UL/C-UL Recognized UL 60950 ,  
UL ANSI/ISA-12.12.01 Class I, Division 2, Groups A, B, C, D T4A  
(Hazardous Location)  
EN 61000-3-2

Ordering data

Type	Order No.	Pcs./Pkt.
UNO-PS/1AC/15DC/ 55W	2903001	1

Technical data

100 V AC ... 240 V AC  
85 V AC ... 264 V AC  
45 Hz ... 65 Hz  
1.7 A (120 V AC) / 1 A (230 V AC)  
< 30 A / < 1.5 A<sup>2</sup>s  
> 20 ms (120 V AC) / > 85 ms (230 V AC)

15 V DC ±1 %  
6.67 A  
yes, with redundancy module / yes  
< 0.4 W / < 12 W  
> 89 % (for 230 V AC and nominal values)  
< 75 mV<sub>pp</sub>

LED

0.34 kg / 55 x 90 x 84 mm  
Alignable: 0 mm horizontally, 30 mm vertically  
Screw connection  
0.2 - 2.5 mm<sup>2</sup> / 0.2 - 2.5 mm<sup>2</sup> / 24 - 14  
IP20 / II  
> 727000 h (40°C)  
-25 °C ... 70 °C (> 55° C derating: 2.5%/K)

3 kV AC (routine test) / 4 kV AC (type test)  
Conformance with EMC Directive 2014/30/EU  
IEC 60950-1/VDE 0805 (SELV)  
EN 50178/VDE 0160 (PELV)  
DIN VDE 0100-410  
UL/C-UL listed UL 508 , UL/C-UL Recognized UL 60950 ,  
UL ANSI/ISA-12.12.01 Class I, Division 2, Groups A, B, C, D T4  
(Hazardous Location)  
EN 61000-3-2

Ordering data

Type	Order No.	Pcs./Pkt.
UNO-PS/1AC/15DC/100W	2903002	1

# Power supplies and UPS

## Power supplies

### UNO POWER power supplies – compact basic functionality

#### UNO POWER, 1 AC, 48 V DC

- The wide range of products covers all common voltage levels
- Maximum energy efficiency: save energy thanks to high efficiency and extremely low idling losses
- Save space in the control cabinet thanks to extremely high power density
- Housing depth of 84 mm, tailored to all popular 120 mm control boxes
- Wide temperature range from -25°C to +70°C



Power supply,  
1 AC, 48 DC, 60 W

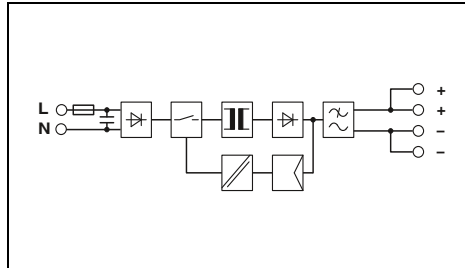

#### Technical data

Input data
Nominal input voltage range
Input voltage range
Frequency range
Current consumption (nominal load)
Inrush current limitation at 25°C / I <sub>pt</sub>
Mains buffering (I <sub>N</sub> , typ.)
Output data
Nominal output voltage
Output current
Can be connected in parallel/series
Max. power dissipation (no load/nominal load)
Efficiency
Residual ripple
Signaling
Signaling DC OK
General data
Weight / Dimensions W x H x D
Assembly instructions
Connection method
Connection data solid/stranded/AWG
Degree of protection / Protection class
MTBF (IEC 61709, SN 29500)
Ambient temperature (operation)
Standards/regulations
Insulation voltage input/output
Electromagnetic compatibility
Electrical safety
Electronic equipm. for electrical power installations
Safe isolation
UL approvals
Limitation of harmonic line currents

100 V AC ... 240 V AC
85 V AC ... 264 V AC
45 Hz ... 65 Hz
1 A (120 V AC) / 0.6 A (230 V AC)
< 30 A / < 0.5 A <sup>2</sup> s
> 20 ms (120 V AC) / > 90 ms (230 V AC)
48 V DC ±1 %
1.25 A
yes, with redundancy module / yes
< 0.4 W / < 7 W
> 90 % (for 230 V AC and nominal values)
< 35 mV <sub>pp</sub>
LED
0.21 kg / 35 x 90 x 84 mm
Alignable: 0 mm horizontally, 30 mm vertically
Screw connection
0.2 - 2.5 mm <sup>2</sup> / 0.2 - 2.5 mm <sup>2</sup> / 24 - 14
IP20 / II
> 1138000 h (40°C)
-25 °C ... 70 °C (> 55° C derating: 2.5%/K)
3 kV AC (routine test) / 4 kV AC (type test)
Conformance with EMC Directive 2014/30/EU
IEC 60950-1/VDE 0805 (SELV)
EN 50178/VDE 0160 (PELV)
DIN VDE 0100-410
UL/C-UL listed UL 508 , UL/C-UL Recognized UL 60950 ,
UL ANSI/ISA-12.12.01 Class I, Division 2, Groups A, B, C, D T4A
(Hazardous Location)
EN 61000-3-2

#### Ordering data

Type	Order No.	Pcs./Pkt.
UNO-PS/1AC/48DC/ 60W	2902995	1



Power supply,  
1 AC, 48 DC, 100 W

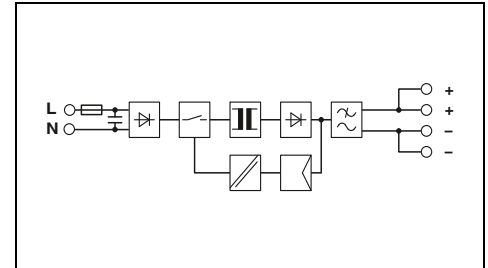

#### Technical data

100 V AC ... 240 V AC
85 V AC ... 264 V AC
45 Hz ... 65 Hz
1.7 A (120 V AC) / 1 A (230 V AC)
< 40 A / < 1.4 A <sup>2</sup> s
> 25 ms (120 V AC) / > 90 ms (230 V AC)
48 V DC ±1 %
2.1 A
yes, with redundancy module / yes
< 0.4 W / < 11 W
> 90 % (for 230 V AC and nominal values)
< 40 mV <sub>pp</sub>
LED
0.34 kg / 55 x 90 x 84 mm
Alignable: 0 mm horizontally, 30 mm vertically
Screw connection
0.2 - 2.5 mm <sup>2</sup> / 0.2 - 2.5 mm <sup>2</sup> / 24 - 14
IP20 / II
> 1010000 h (40°C)
-25 °C ... 70 °C (> 55° C derating: 2.5%/K)
3 kV AC (routine test) / 4 kV AC (type test)
Conformance with EMC Directive 2014/30/EU
IEC 60950-1/VDE 0805 (SELV)
EN 50178/VDE 0160 (PELV)
DIN VDE 0100-410
UL/C-UL listed UL 508 , UL/C-UL Recognized UL 60950 ,
UL ANSI/ISA-12.12.01 Class I, Division 2, Groups A, B, C, D T4
(Hazardous Location)
EN 61000-3-2

#### Ordering data

Type	Order No.	Pcs./Pkt.
UNO-PS/1AC/48DC/100W	2902996	1

**UNO POWER power supplies – DC/DC converter**

**UNO POWER, input up to 1000 V**

- Connect directly to the PV string: no need to supply an AC connection
- Robust and reliable at temperatures from -25°C to +70°C
- Can also be used in small control boxes, thanks to the compact design and high degree of efficiency
- Simplified startup, thanks to LED function monitoring



new

**DC/DC converter,  
350 - 900 V DC, 24 V DC, 60 W**

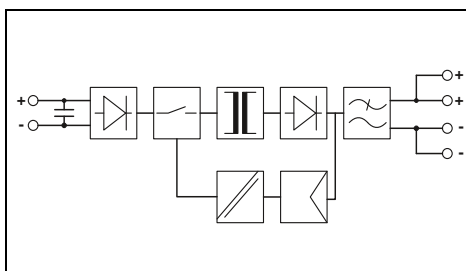

**Technical data**

<b>Input data</b>	
Nominal input voltage range	350 V DC ... 900 V DC
Input voltage range	300 V DC ... 1000 V DC
Frequency range	-
Current consumption (nominal load)	0.19 A (350 V DC) / 0.07 A (1000 V DC)
Inrush current limitation at 25°C / I <sup>2</sup> t	< 1 A / < 0.38 A <sup>2</sup> s
Mains buffering (I <sub>N</sub> , typ.)	
<b>Output data</b>	
Nominal output voltage	24 V DC ±1 %
Output current	2.5 A
Can be connected in parallel/series	yes, with redundancy module / No
Max. power dissipation (no load/nominal load)	< 0.5 W / < 6.5 W
Efficiency	> 90 %
Residual ripple	< 20 mV <sub>pp</sub>
<b>Signaling</b>	
Signaling DC OK	LED
<b>General data</b>	
Weight / Dimensions W x H x D	0.3 kg / 55 x 90 x 84 mm
Assembly instructions	Alignable: 0 mm horizontally, 30 mm vertically
Connection method	Screw connection
Connection data solid/stranded/AWG	0.2 - 2.5 mm <sup>2</sup> / 0.2 - 2.5 mm <sup>2</sup> / 24 - 14
Degree of protection / Protection class	IP20 / II
MTBF (IEC 61709, SN 29500)	> 1160000 h (40°C)
Ambient temperature (operation)	-25 °C ... 70 °C (> 55° C derating: 2.5%/K)
<b>Standards/regulations</b>	
Insulation voltage input/output	3 kV DC (routine test) / 8 kV DC (type test)
Electromagnetic compatibility	Conformance with EMC Directive 2014/30/EU
Electrical safety	-
Electronic equipm. for electrical power installations	-
Safe isolation	DIN VDE 0100-410
UL approvals	UL 1741 , IEC 62109-1
Limitation of harmonic line currents	EN 61000-3-2

**Ordering data**

Description	Type	Order No.	Pcs./Pkt.
	DC/DC converter, primary-switched	UNO-PS/350-900DC/24DC/60W	2906300

# Power supplies and UPS

## Power supplies

### MINI POWER power supplies – for measurement and control technology

#### MINI POWER, 1 AC, 24 V DC

- Easy-to-maintain connection method thanks to coded COMBICON connector
- Remote monitoring of output voltage via switching output

#### MINI POWER, NEC Class 2

- Output power limited to 100 W: Specifically for applications that require certification according to UL 1310/508 Listed Class 2



Power supply,  
1 AC, 24 V DC, 1.3 A  
NEC Class 2



Power supply,  
1 AC, 24 V DC, 1.5 A,  
DIN rail connector optional

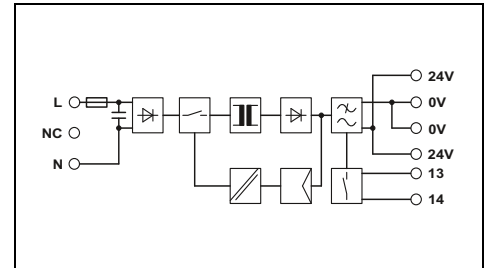
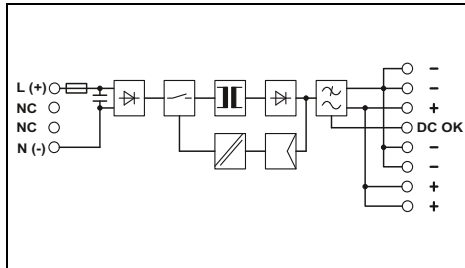

#### Technical data

Input data	
Nominal input voltage range	100 V AC ... 240 V AC
Input voltage range	85 V AC ... 264 V AC 90 V DC ... 350 V DC
Frequency range	45 Hz ... 65 Hz / 0 Hz
Current consumption (nominal load)	0.55 A (100 V AC) / 0.23 A (240 V AC)
Inrush current limitation at 25°C / I <sub>pt</sub>	< 15 A / 0.6 A <sup>2</sup> s
Mains buffering (I <sub>N</sub> , typ.)	> 20 ms (120 V AC) / > 110 ms (230 V AC)
Output data	
Nominal output voltage	24 V DC ±1 %
Setting range of the output voltage (U <sub>set</sub> )	22.5 V DC ... 28.5 V DC (> 24 V DC, constant capacity restricted)
Output current / Power Boost	1.3 A / 1.6 A
Can be connected in parallel/series	Yes / yes
Max. power dissipation (no load/nominal load)	1.4 W / 4.5 W
Efficiency	> 85 % (for 230 V AC and nominal values)
Residual ripple	< 20 mV <sub>pp</sub>
Signaling	
Signaling DC OK	LED, active switching output
General data	
Weight / Dimensions W x H x D	0.2 kg / 22.5 x 99 x 107 mm
Assembly instructions	Can be aligned: Horizontally 0 mm, vertically 50 mm
Connection method	Plug-in screw connection
Connection data solid/stranded/AWG	0.2 - 2.5 mm <sup>2</sup> / 0.2 - 2.5 mm <sup>2</sup> / 24 - 12
Degree of protection / Protection class	IP20 / II
MTBF (IEC 61709, SN 29500)	> 1104000 h (40°C)
Ambient temperature (operation)	-25 °C ... 70 °C (> 60 °C derating: 2.5%/K)
Standards/regulations	
Insulation voltage input/output	3 kV (routine test) / 4 kV (type test)
Electromagnetic compatibility	Conformance with EMC Directive 2014/30/EU
Electrical safety	EN 60950-1/VDE 0805 (SELV)
Electronic equipm. for electrical power installations	EN 50178/VDE 0160 (PELV)
Safe isolation	DIN VDE 0100-410
UL approvals	UL/C-UL listed UL 508 , UL/C-UL Recognized UL 60950 , UL ANSI/ISA-12.12.01 Class I, Division 2, Groups A, B, C, D (Hazardous Location) , NEC Class 2 as per UL 1310
Limitation of harmonic line currents	EN 61000-3-2

Technical data	
100 V AC ... 240 V AC	
85 V AC ... 264 V AC	
45 Hz ... 65 Hz	
0.75 A (120 V AC) / 0.45 A (230 V AC)	
< 15 A / 0.6 A <sup>2</sup> s	
> 35 ms (120 V AC) / > 150 ms (230 V AC)	
24 V DC ±1 %	
-	
1.5 A / 2 A	
Yes / No	
1.5 W / 6.5 W	
> 84 % (for 230 V AC and nominal values)	
< 40 mV <sub>pp</sub>	
LED, relay contact	
0.25 kg / 35 x 99 x 95 mm	
Can be aligned: Horizontally 0 mm, vertically 50 mm	
Plug-in screw connection	
0.2 - 2.5 mm <sup>2</sup> / 0.2 - 2.5 mm <sup>2</sup> / 24 - 12	
IP20 / II	
> 2789000 h (40°C)	
-25 °C ... 70 °C (> 60 °C derating: 2.5%/K)	
3 kV (routine test) / 4 kV (type test)	
Conformance with EMC Directive 2014/30/EU	
EN 60950-1/VDE 0805 (SELV)	
EN 50178/VDE 0160 (PELV)	
DIN VDE 0100-410	
UL/C-UL listed UL 508 , UL/C-UL Recognized UL 60950 , UL ANSI/ISA-12.12.01 Class I, Division 2, Groups A, B, C, D (Hazardous Location)	
EN 61000-3-2	

#### Ordering data

Type	Order No.	Pcs./Pkt.
Power supply, primary-switched		
MINI-PS-100-240AC/24DC/1.3	2866446	1

Type	Order No.	Pcs./Pkt.
Power supply, primary-switched		
MINI-SYS-PS-100-240AC/24DC/1.5	2866983	1

#### Accessories

DIN rail connector (optional), for routing through the supply voltage and data signal, two pieces are required per device		
---	--	--

Accessories		
ME 17.5 TBUS 1.5/5-ST-3.81 GN	2709561	10



Power supply,  
1 AC, 24 V DC, 2 A  
NEC Class 2



Power supply,  
1 AC, 24 V DC, 100 W  
NEC Class 2



Power supply,  
1 AC, 24 V DC, 4 A

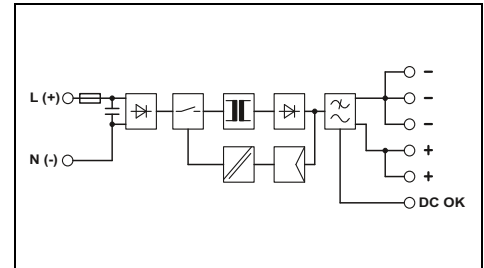
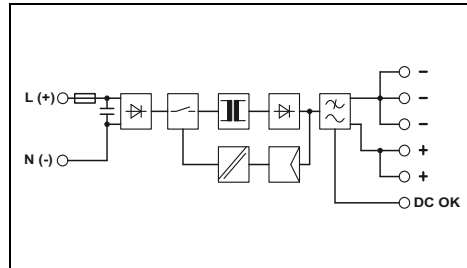
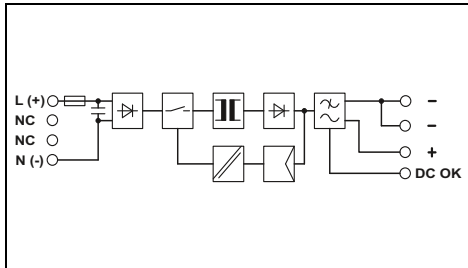

Technical data

100 V AC ... 240 V AC  
85 V AC ... 264 V AC  
90 V DC ... 350 V DC  
45 Hz ... 65 Hz  
0.7 A (120 V AC) / 0.4 A (230 V AC)  
< 15 A / 4.1 A<sup>2s</sup>  
> 35 ms (120 V AC) / > 170 ms (230 V AC)

24 V DC ±1 %  
22.5 V DC ... 28.5 V DC (> 24 V DC, constant capacity restricted)

2 A / 2.9 A  
Yes / yes  
2 W / 7 W  
> 88 % (for 230 V AC and nominal values)  
< 20 mV<sub>pp</sub>

LED, active switching output

0.25 kg / 45 x 99 x 107 mm  
Can be aligned: Horizontally 0 mm, vertically 50 mm  
Plug-in screw connection  
0.2 - 2.5 mm<sup>2</sup> / 0.2 - 2.5 mm<sup>2</sup> / 24 - 12  
IP20 / II  
> 507000 h (40°C)  
-25 °C ... 70 °C (> 60 °C derating: 2.5%/K)

3 kV (routine test) / 4 kV (type test)  
Conformance with EMC Directive 2014/30/EU  
EN 60950-1/VDE 0805 (SELV)  
EN 50178/VDE 0160 (PELV)  
DIN VDE 0100-410  
UL/C-UL listed UL 508 , UL/C-UL Recognized UL 60950 ,  
UL ANSI/ISA-12.12.01 Class I, Division 2, Groups A, B, C, D  
(Hazardous Location) , NEC Class 2 as per UL 1310  
EN 61000-3-2

Ordering data

Type	Order No.	Pcs./Pkt.
MINI-PS-100-240AC/24DC/2	2938730	1

Accessories

Technical data

100 V AC ... 240 V AC  
85 V AC ... 264 V AC  
90 V DC ... 350 V DC  
45 Hz ... 65 Hz  
1.3 A (120 V AC) / 0.8 A (230 V AC)  
< 15 A / 2.1 A<sup>2s</sup>  
> 20 ms (120 V AC) / > 100 ms (230 V AC)

24 V DC ±1 %  
22.5 V DC ... 26 V DC (> 24 V DC, constant capacity restricted)

3.8 A / -  
Yes / yes  
2.5 W / 12 W  
> 88 % (for 230 V AC and nominal values)  
< 40 mV<sub>pp</sub>

LED, active switching output

0.4 kg / 67.5 x 99 x 107 mm  
Can be aligned: Horizontally 0 mm, vertically 50 mm  
Plug-in screw connection  
0.2 - 2.5 mm<sup>2</sup> / 0.2 - 2.5 mm<sup>2</sup> / 24 - 12  
IP20 / II  
> 815000 h (40°C)  
-25 °C ... 70 °C (> 60 °C derating: 2.5%/K)

3 kV (routine test) / 3 kV (type test)  
Conformance with EMC Directive 2014/30/EU  
EN 60950-1/VDE 0805 (SELV)  
EN 50178/VDE 0160 (PELV)  
DIN VDE 0100-410  
UL/C-UL listed UL 508 , UL/C-UL Recognized UL 60950 ,  
UL ANSI/ISA-12.12.01 Class I, Division 2, Groups A, B, C, D  
(Hazardous Location) , NEC Class 2 as per UL 1310  
EN 61000-3-2

Ordering data

Type	Order No.	Pcs./Pkt.
MINI-PS-100-240AC/24DC/C2LPS	2866336	1

Accessories

Technical data

100 V AC ... 240 V AC  
85 V AC ... 264 V AC  
90 V DC ... 350 V DC  
45 Hz ... 65 Hz  
1.3 A (120 V AC) / 0.8 A (230 V AC)  
< 15 A / 2.1 A<sup>2s</sup>  
> 20 ms (120 V AC) / > 100 ms (230 V AC)

24 V DC ±1 %  
22.5 V DC ... 28.5 V DC (> 24 V DC, constant capacity restricted)

4 A / 5 A  
Yes / yes  
2.5 W / 12 W  
> 88 % (for 230 V AC and nominal values)  
< 20 mV<sub>pp</sub>

LED, active switching output

0.4 kg / 67.5 x 99 x 107 mm  
Can be aligned: Horizontally 0 mm, vertically 50 mm  
Plug-in screw connection  
0.2 - 2.5 mm<sup>2</sup> / 0.2 - 2.5 mm<sup>2</sup> / 24 - 12  
IP20 / II  
> 815000 h (40°C)  
-25 °C ... 70 °C (> 60 °C derating: 2.5%/K)

3 kV (routine test) / 3 kV (type test)  
Conformance with EMC Directive 2014/30/EU  
EN 60950-1/VDE 0805 (SELV)  
EN 50178/VDE 0160 (PELV)  
DIN VDE 0100-410  
UL/C-UL listed UL 508 , UL/C-UL Recognized UL 60950 ,  
UL ANSI/ISA-12.12.01 Class I, Division 2, Groups A, B, C, D  
(Hazardous Location)  
EN 61000-3-2

Ordering data

Type	Order No.	Pcs./Pkt.
MINI-PS-100-240AC/24DC/4	2938837	1

Accessories

# Power supplies and UPS

## Power supplies

### MINI POWER power supplies – for measurement and control technology

#### MINI POWER, 1 AC, 5 to 15 V DC

- Easy-to-maintain connection method thanks to coded COMBICON connector
- Remote monitoring of output voltage via switching output

#### MINI POWER, ±15 V DC

- For supplying operational amplifiers

#### MINI POWER EX

- Corresponds to standard EN 60079-15
- Installation in a potentially explosive area in which category 3G equipment is required (Zone 2).



Power supply,  
1 AC, 5 V DC, 3 A

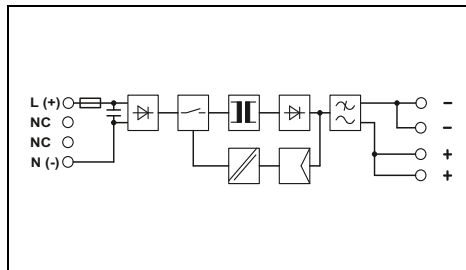

Power supply,  
1 AC, 10 - 15 V DC, 2 A

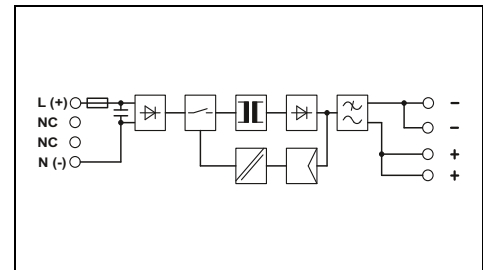

<b>Input data</b>	
Nominal input voltage range	100 V AC ... 240 V AC
Input voltage range	85 V AC ... 264 V AC 90 V DC ... 350 V DC
<b>Frequency range</b>	
Current consumption (nominal load)	45 Hz ... 65 Hz
Inrush current limitation at 25°C / I <sub>pt</sub>	0.4 A (120 V AC) / 0.2 A (230 V AC)
Mains buffering (I <sub>N</sub> , typ.)	< 15 A / 1.5 A <sup>2</sup> s > 30 ms (120 V AC) / > 140 ms (230 V AC)
<b>Output data</b>	
Nominal output voltage	5 V DC ±1 %
Setting range of the output voltage (U <sub>set</sub> )	4.5 V DC ... 5.5 V DC (> 5 V DC, constant capacity restricted)
<b>Output current / Power Boost</b>	
Can be connected in parallel/series	3 A / 5 A Yes / yes
Max. power dissipation (no load/nominal load)	1 W / 5 W
Efficiency	> 73 % (for 230 V AC and nominal values)
Residual ripple	< 40 mV <sub>pp</sub>
<b>Signaling</b>	
Signaling DC OK	LED
<b>General data</b>	
Weight / Dimensions W x H x D	0.17 kg / 22.5 x 99 x 107 mm
Assembly instructions	Can be aligned: Horizontally 0 mm, vertically 50 mm
Connection method	Plug-in screw connection
Connection data solid/stranded/AWG	0.2 - 2.5 mm <sup>2</sup> / 0.2 - 2.5 mm <sup>2</sup> / 24 - 12
Degree of protection / Protection class	IP20 / II
MTBF (IEC 61709, SN 29500)	> 766000 h (40°C)
Ambient temperature (operation)	-25 °C ... 70 °C (> 60 °C derating: 2.5%/K)
<b>Standards/regulations</b>	
Insulation voltage input/output	3 kV (routine test) / 4 kV (type test)
Electromagnetic compatibility	Conformance with EMC Directive 2014/30/EU
Electrical safety	EN 60950-1/VDE 0805 (SELV)
Electronic equipm. for electrical power installations	EN 50178/VDE 0160 (PELV)
Safe isolation	DIN VDE 0100-410
UL approvals	UL/C-UL listed UL 508 , UL/C-UL Recognized UL 60950 , UL ANSI/ISA-12.12.01 Class I, Division 2, Groups A, B, C, D (Hazardous Location)
Limitation of harmonic line currents	EN 61000-3-2

<b>Technical data</b>		
100 V AC ... 240 V AC		
85 V AC ... 264 V AC		
90 V DC ... 350 V DC		
45 Hz ... 65 Hz		
0.4 A (120 V AC) / 0.2 A (230 V AC)		
< 15 A / 1.5 A <sup>2</sup> s		
> 30 ms (120 V AC) / > 140 ms (230 V AC)		
5 V DC ±1 %		
4.5 V DC ... 5.5 V DC (> 5 V DC, constant capacity restricted)		
3 A / 5 A		
Yes / yes		
1 W / 5 W		
> 73 % (for 230 V AC and nominal values)		
< 40 mV <sub>pp</sub>		
LED		
0.17 kg / 22.5 x 99 x 107 mm		
Can be aligned: Horizontally 0 mm, vertically 50 mm		
Plug-in screw connection		
0.2 - 2.5 mm <sup>2</sup> / 0.2 - 2.5 mm <sup>2</sup> / 24 - 12		
IP20 / II		
> 766000 h (40°C)		
-25 °C ... 70 °C (> 60 °C derating: 2.5%/K)		
3 kV (routine test) / 4 kV (type test)		
Conformance with EMC Directive 2014/30/EU		
EN 60950-1/VDE 0805 (SELV)		
EN 50178/VDE 0160 (PELV)		
DIN VDE 0100-410		
UL/C-UL listed UL 508 , UL/C-UL Recognized UL 60950 , UL ANSI/ISA-12.12.01 Class I, Division 2, Groups A, B, C, D (Hazardous Location)		
EN 61000-3-2		

<b>Technical data</b>		
100 V AC ... 240 V AC		
85 V AC ... 264 V AC		
90 V DC ... 350 V DC		
45 Hz ... 65 Hz		
0.4 A (120 V AC) / 0.2 A (230 V AC)		
< 15 A / 1.7 A <sup>2</sup> s		
> 20 ms (120 V AC) / > 120 ms (230 V AC)		
12 V DC ±1 %		
10 V DC ... 15 V DC (> 12 V DC, constant capacity restricted)		
2 A / 2.3 A		
Yes / yes		
< 1 W / < 7 W		
> 86 % (for 230 V AC and nominal values)		
< 20 mV <sub>pp</sub>		
LED		
0.25 kg / 45 x 99 x 107 mm		
Can be aligned: Horizontally 0 mm, vertically 50 mm		
Plug-in screw connection		
0.2 - 2.5 mm <sup>2</sup> / 0.2 - 2.5 mm <sup>2</sup> / 24 - 12		
IP20 / II		
> 507000 h (40°C)		
-25 °C ... 70 °C (> 60 °C derating: 2.5%/K)		
3 kV (routine test) / 4 kV (type test)		
Conformance with EMC Directive 2014/30/EU		
EN 60950-1/VDE 0805 (SELV)		
EN 50178/VDE 0160 (PELV)		
DIN VDE 0100-410		
UL/C-UL listed UL 508 , UL/C-UL Recognized UL 60950 , UL ANSI/ISA-12.12.01 Class I, Division 2, Groups A, B, C, D (Hazardous Location)		
EN 61000-3-2		

<b>Ordering data</b>			
Description	Type	Order No.	Pcs./Pkt.
Power supply, primary-switched	MINI-PS-100-240AC/ 5DC/3	2938714	1

<b>Ordering data</b>			
Description	Type	Order No.	Pcs./Pkt.
Power supply, primary-switched	MINI-PS-100-240AC/10-15DC/2	2938756	1

**DIN rail connector** (optional), for routing through the supply voltage and data signal, two pieces are required per device

<b>Accessories</b>		

<b>Accessories</b>		



Power supply,  
1 AC, 10 - 15 V DC, 8 A



Power supply,  
1 AC, ±15 V DC, 1 A  
NEC Class 2



Power supply  
1 AC, 24 DC, 1.5 A  
DIN rail connector optional

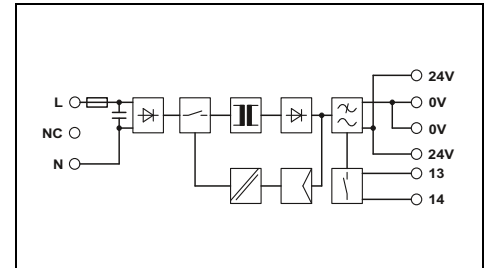
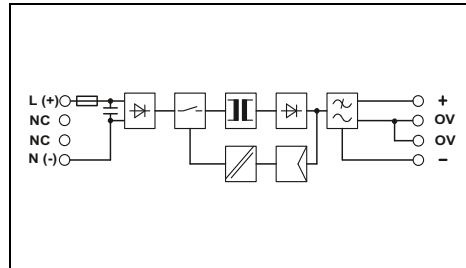
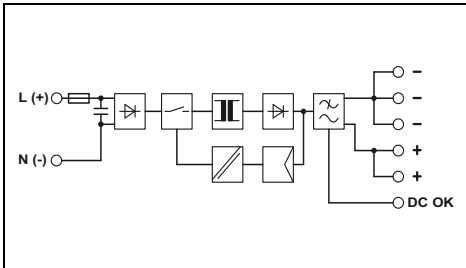

Technical data	
100 V AC ... 240 V AC	85 V AC ... 264 V AC
90 V DC ... 350 V DC	45 Hz ... 65 Hz
1.3 A (120 V AC) / 0.8 A (230 V AC)	< 15 A / 2.1 A <sup>2</sup> s
> 20 ms (120 V AC) / > 20 ms (230 V AC)	12 V DC ±1 %
10 V DC ... 15 V DC (> 12 V DC, constant capacity restricted)	8 A
Yes / yes	< 2.5 W / < 12 W
> 88 % (for 230 V AC and nominal values)	< 40 mV <sub>pp</sub>
LED, active switching output	LED
0.4 kg / 67.5 x 99 x 107 mm	0.25 kg / 45 x 99 x 107 mm
Can be aligned: Horizontally 0 mm, vertically 50 mm	Can be aligned: Horizontally 0 mm, vertically 50 mm
Plug-in screw connection	Plug-in screw connection
0.2 - 2.5 mm <sup>2</sup> / 0.2 - 2.5 mm <sup>2</sup> / 24 - 12	0.2 - 2.5 mm <sup>2</sup> / 0.2 - 2.5 mm <sup>2</sup> / 24 - 12
IP20 / II	IP20 / II
> 984000 h (40°C)	> 500000 h (40°C)
-25 °C ... 70 °C (> 60 °C derating: 2.5%/K)	-25 °C ... 70 °C (> 60 °C derating: 2.5%/K)
3 kV (routine test) / 3 kV (type test)	3 kV (routine test) / 4 kV (type test)
Conformance with EMC Directive 2014/30/EU	Conformance with EMC Directive 2014/30/EU
EN 60950-1/VDE 0805 (SELV)	EN 60950-1/VDE 0805 (SELV)
EN 50178/VDE 0160 (PELV)	EN 50178/VDE 0160 (PELV)
DIN VDE 0100-410	DIN VDE 0100-410
UL/C-UL listed UL 508 , UL/C-UL Recognized UL 60950 , UL ANSI/ISA-12.12.01 Class I, Division 2, Groups A, B, C, D (Hazardous Location)	UL/C-UL listed UL 508 , UL/C-UL Recognized UL 60950 , UL ANSI/ISA-12.12.01 Class I, Division 2, Groups A, B, C, D (Hazardous Location) , NEC Class 2 as per UL 1310
EN 61000-3-2	EN 61000-3-2

Technical data	
100 V AC ... 240 V AC	85 V AC ... 264 V AC
90 V DC ... 350 V DC	45 Hz ... 65 Hz
0.6 A (120 V AC) / 0.4 A (230 V AC)	< 35 A / 4 A <sup>2</sup> s
> 30 ms (120 V AC) / > 150 ms (230 V AC)	± 15 V DC ±1 %
1 A / 1.5 A	-
Yes / yes	1 A / 1.5 A
> 80 % (for 230 V AC and nominal values)	< 30 mV <sub>pp</sub>
LED	LED
0.25 kg / 45 x 99 x 107 mm	0.25 kg / 35 x 99 x 95 mm
Can be aligned: Horizontally 0 mm, vertically 50 mm	Can be aligned: Horizontally 0 mm, vertically 50 mm
Plug-in screw connection	Plug-in screw connection
0.2 - 2.5 mm <sup>2</sup> / 0.2 - 2.5 mm <sup>2</sup> / 24 - 12	0.2 - 2.5 mm <sup>2</sup> / 0.2 - 2.5 mm <sup>2</sup> / 24 - 12
IP20 / II	IP20 / II
> 500000 h (40°C)	> 2789000 h (40°C)
-25 °C ... 70 °C (> 60 °C derating: 2.5%/K)	-25 °C ... 70 °C (> 60 °C derating: 2.5%/K)
3 kV (routine test) / 4 kV (type test)	3 kV AC (routine test) / 4 kV AC (type test)
Conformance with EMC Directive 2014/30/EU	Conformance with EMC Directive 2014/30/EU
EN 60950-1/VDE 0805 (SELV)	EN 60950-1/VDE 0805 (SELV)
EN 50178/VDE 0160 (PELV)	EN 50178/VDE 0160 (PELV)
DIN VDE 0100-410	DIN VDE 0100-410
UL/C-UL listed UL 508 , UL/C-UL Recognized UL 60950 , UL ANSI/ISA-12.12.01 Class I, Division 2, Groups A, B, C, D (Hazardous Location) , NEC Class 2 as per UL 1310	UL/C-UL listed UL 508 , UL/C-UL Recognized UL 60950
EN 61000-3-2	EN 61000-3-2

Technical data	
100 V AC ... 240 V AC	85 V AC ... 264 V AC
45 Hz ... 65 Hz	0.75 A (120 V AC) / 0.45 A (230 V AC)
< 15 A / 0.6 A <sup>2</sup> s	< 15 A / 0.6 A <sup>2</sup> s
> 35 ms (120 V AC) / > 150 ms (230 V AC)	24 V DC ±1 %
1.5 A / 2 A	-
Yes / yes	1.5 A / 2 A
> 84 % (for 230 V AC and nominal values)	< 40 mV <sub>pp</sub>
LED, relay contact	LED, relay contact
0.25 kg / 67.5 x 99 x 107 mm	0.25 kg / 35 x 99 x 95 mm
Can be aligned: Horizontally 0 mm, vertically 50 mm	Can be aligned: Horizontally 0 mm, vertically 50 mm
Plug-in screw connection	Plug-in screw connection
0.2 - 2.5 mm <sup>2</sup> / 0.2 - 2.5 mm <sup>2</sup> / 24 - 12	0.2 - 2.5 mm <sup>2</sup> / 0.2 - 2.5 mm <sup>2</sup> / 24 - 12
IP20 / II	IP20 / II
> 984000 h (40°C)	> 2789000 h (40°C)
-25 °C ... 70 °C (> 60 °C derating: 2.5%/K)	-25 °C ... 70 °C (> 60 °C derating: 2.5%/K)
3 kV (routine test) / 3 kV (type test)	3 kV AC (routine test) / 4 kV AC (type test)
Conformance with EMC Directive 2014/30/EU	Conformance with EMC Directive 2014/30/EU
EN 60950-1/VDE 0805 (SELV)	EN 60950-1/VDE 0805 (SELV)
EN 50178/VDE 0160 (PELV)	EN 50178/VDE 0160 (PELV)
DIN VDE 0100-410	DIN VDE 0100-410
UL/C-UL listed UL 508 , UL/C-UL Recognized UL 60950	UL/C-UL listed UL 508 , UL/C-UL Recognized UL 60950
EN 61000-3-2	EN 61000-3-2

Ordering data		
Type	Order No.	Pcs./Pkt.
MINI-PS-100-240AC/10-15DC/8	2866297	1

Accessories		

Ordering data		
Type	Order No.	Pcs./Pkt.
MINI-PS-100-240AC/2X15DC/1	2938743	1

Accessories		

Ordering data		
Type	Order No.	Pcs./Pkt.
MINI-PS-100-240AC/24DC/1.5/EX	2866653	1

Accessories		
ME 17,5 TBUS 1,5/ 5-ST-3,81 GN	2709561	10

# Power supplies and UPS

## Power supplies

### STEP POWER power supplies – for installation distributors and flat control panels

#### STEP POWER, 1 AC, 24 V DC

- Flexible assembly by simply snapping the product onto the DIN rail or screwing it onto an even surface
- Energy savings thanks to maximum energy efficiency and incredibly low no-load losses
- Wide temperature range from -25°C to +70°C
- Reliable supply thanks to the high MTBF (mean time between failure)

#### STEP POWER, 24 V DC, 0.5 A

- Slim design with an overall width of just 18 mm (1 pitch)

#### STEP POWER, 24 V DC, 0.75 A

- Meets standard EN 60335-1 for household appliances, suitable for installation in ventilation systems, for example
- Flat design with a depth of just 43 mm

#### STEP POWER, 48 V AC, 0.5 A

- Connection to 48 V AC operating networks
- Slim design with an overall width of just 18 mm (1 pitch)



Power supply,  
1 AC, 24 V DC, 0.5 A  
NEC Class 2

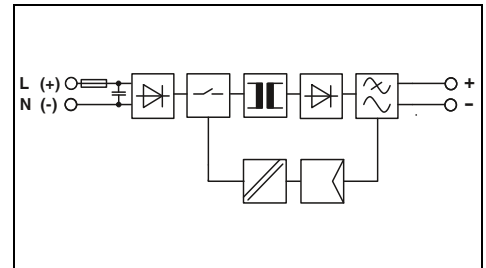

<b>Input data</b>	
Nominal input voltage range	100 V AC ... 240 V AC
Input voltage range	85 V AC ... 264 V AC 95 V DC ... 250 V DC
Frequency range	45 Hz ... 65 Hz / 0 Hz
Current consumption (nominal load)	0.28 A (120 V AC) / 0.13 A (230 V AC)
Inrush current limitation at 25°C / I <sub>t</sub>	< 15 A / < 0.1 A <sup>2</sup> s
Mains buffering (I <sub>N</sub> , typ.)	> 15 ms (120 V AC) / > 90 ms (230 V AC)
<b>Output data</b>	
Nominal output voltage	24 V DC ±1 %
Output current	0.5 A
Can be connected in parallel/series	Yes / yes
Max. power dissipation (no load/nominal load)	< 0.3 W / < 2.2 W
Efficiency	> 84 % (for 230 V AC and nominal values)
Residual ripple	< 20 mV <sub>PP</sub>
<b>Signaling</b>	
Signaling DC OK	LED
<b>General data</b>	
Weight / Dimensions W x H x D	0.07 kg / 18 x 90 x 61 mm
Assembly instructions	Alignable: 0 mm horizontally, 30 mm vertically
Connection method	Screw connection
Connection data solid/stranded/AWG	0.2 - 2.5 mm <sup>2</sup> / 0.2 - 2.5 mm <sup>2</sup> / 24 - 12
Degree of protection / Protection class	IP20 / II
MTBF (IEC 61709, SN 29500)	> 1567000 h (40°C)
Ambient temperature (operation)	-25 °C ... 70 °C (> 55 °C derating: 2.5%/K)
<b>Standards/regulations</b>	
Insulation voltage input/output	3.75 kV AC (routine test) / 4 kV AC (type test)
Electromagnetic compatibility	Conformance with EMC Directive 2014/30/EU
Electrical safety	IEC 60950-1/VDE 0805 (SELV)
Electronic equipm. for electrical power installations	EN 50178/VDE 0160 (PELV)
Safe isolation	DIN VDE 0100-410
Budgetary standard	-
UL approvals	UL/C-UL listed UL 508 , UL/C-UL Recognized UL 60950 , UL ANSI/ISA-12.12.01 Class I, Division 2, Groups A, B, C, D (Hazardous Location) , NEC Class 2 as per UL 1310 EN 61000-3-2

Technical data		
100 V AC ... 240 V AC		
85 V AC ... 264 V AC		
95 V DC ... 250 V DC		
45 Hz ... 65 Hz / 0 Hz		
0.28 A (120 V AC) / 0.13 A (230 V AC)		
< 15 A / < 0.1 A <sup>2</sup> s		
> 15 ms (120 V AC) / > 90 ms (230 V AC)		
24 V DC ±1 %		
0.5 A		
Yes / yes		
< 0.3 W / < 2.2 W		
> 84 % (for 230 V AC and nominal values)		
< 20 mV <sub>PP</sub>		
LED		
0.07 kg / 18 x 90 x 61 mm		
Alignable: 0 mm horizontally, 30 mm vertically		
Screw connection		
0.2 - 2.5 mm <sup>2</sup> / 0.2 - 2.5 mm <sup>2</sup> / 24 - 12		
IP20 / II		
> 1567000 h (40°C)		
-25 °C ... 70 °C (> 55 °C derating: 2.5%/K)		
3.75 kV AC (routine test) / 4 kV AC (type test)		
Conformance with EMC Directive 2014/30/EU		
IEC 60950-1/VDE 0805 (SELV)		
EN 50178/VDE 0160 (PELV)		
DIN VDE 0100-410		
-		
UL/C-UL listed UL 508 , UL/C-UL Recognized UL 60950 , UL ANSI/ISA-12.12.01 Class I, Division 2, Groups A, B, C, D (Hazardous Location) , NEC Class 2 as per UL 1310 EN 61000-3-2		

Limitation of harmonic line currents

Description	Power supply, primary-switched
-------------	--------------------------------

Ordering data		
Type	Order No.	Pcs./Pkt.
STEP-PS/ 1AC/24DC/0.5	2868596	1



Power supply,  
1 AC, 24 V DC, 0.75 A  
flat design, NEC Class 2

UL US ENEC ClassNK CB  
Ex:



Power supply,  
1 AC, 24 V DC, 0.75 A  
NEC Class 2

UL US ENEC DNV GL ClassNK CB  
Ex:



Power supply,  
48 V AC, 24 V DC, 0.5 A  
NEC Class 2

UL US ENEC CB

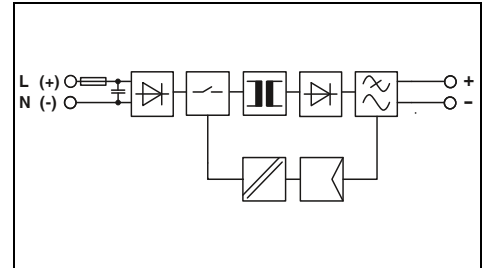
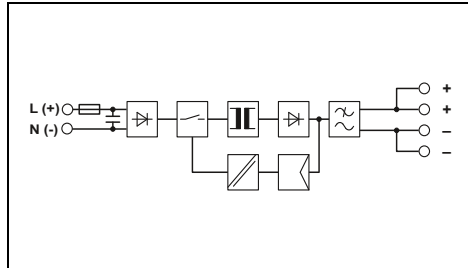
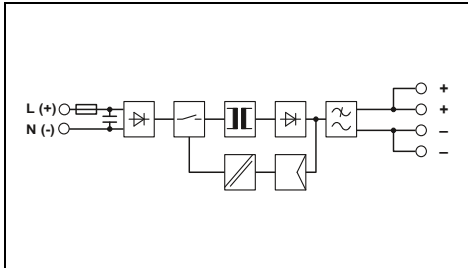

Technical data

100 V AC ... 240 V AC  
85 V AC ... 264 V AC  
95 V DC ... 250 V DC  
45 Hz ... 65 Hz / 0 Hz  
0.3 A (120 V AC) / 0.25 A (230 V AC)  
< 15 A / < 0.1 A<sup>2</sup>s  
> 15 ms (120 V AC) / > 70 ms (230 V AC)

24 V DC ±1 %  
0.75 A  
Yes / yes  
< 0.5 W / < 3.6 W  
> 84 % (for 230 V AC and nominal values)  
< 75 mV<sub>pp</sub>

LED

0.11 kg / 36 x 90 x 43 mm  
Alignable: 0 mm horizontally, 30 mm vertically  
Screw connection  
0.2 - 2.5 mm<sup>2</sup> / 0.2 - 2.5 mm<sup>2</sup> / 24 - 12  
IP20 / II  
> 926000 h (40°C)  
-25 °C ... 70 °C (> 55° C derating: 2.5%/K)

3.75 kV AC (routine test) / 4 kV AC (type test)  
Conformance with EMC Directive 2014/30/EU  
IEC 60950-1/VDE 0805 (SELV)  
EN 50178/VDE 0160 (PELV)  
DIN VDE 0100-410  
IEC 60335-1  
UL/C-UL listed UL 508 , UL/C-UL Recognized UL 60950 ,  
UL ANSI/ISA-12.12.01 Class I, Division 2, Groups A, B, C, D  
(Hazardous Location) , NEC Class 2 as per UL 1310  
EN 61000-3-2

Ordering data

Type	Order No.	Pcs./Pkt.
STEP-PS/1AC/24DC/0.75/FL	2868622	1

Technical data

100 V AC ... 240 V AC  
85 V AC ... 264 V AC  
95 V DC ... 250 V DC  
45 Hz ... 65 Hz / 0 Hz  
0.3 A (120 V AC) / 0.2 A (230 V AC)  
< 15 A / < 0.1 A<sup>2</sup>s  
> 15 ms (120 V AC) / > 70 ms (230 V AC)

24 V DC ±1 %  
0.75 A  
Yes / yes  
0.5 W / 3.6 W  
> 84 % (for 230 V AC and nominal values)  
< 75 mV<sub>pp</sub>

LED

0.11 kg / 36 x 90 x 61 mm  
Alignable: 0 mm horizontally, 30 mm vertically  
Screw connection  
0.2 - 2.5 mm<sup>2</sup> / 0.2 - 2.5 mm<sup>2</sup> / 24 - 12  
IP20 / II  
> 926000 h (40°C)  
-25 °C ... 70 °C (> 55° C derating: 2.5%/K)

3.75 kV AC (routine test) / 4 kV AC (type test)  
Conformance with EMC Directive 2014/30/EU  
IEC 60950-1/VDE 0805 (SELV)  
EN 50178/VDE 0160 (PELV)  
DIN VDE 0100-410  
IEC 60335-1  
UL/C-UL listed UL 508 , UL/C-UL Recognized UL 60950 ,  
UL ANSI/ISA-12.12.01 Class I, Division 2, Groups A, B, C, D  
(Hazardous Location) , NEC Class 2 as per UL 1310  
EN 61000-3-2

Ordering data

Type	Order No.	Pcs./Pkt.
STEP-PS/1AC/24DC/0.75	2868635	1

Technical data

48 V AC  
43 V AC ... 52 V AC  
60 V DC ... 80 V DC  
45 Hz ... 65 Hz / 0 Hz  
0.5 A (43 V AC) / 0.45 A (48 V AC)  
< 10 A / < 0.1 A<sup>2</sup>s  
> 15 ms (48 V AC) / > 20 ms (52 V AC)

24 V DC ±1 %  
0.5 A  
Yes / yes  
< 0.3 W / < 3.4 W  
> 81 % (for 48 V AC and nominal values)  
< 30 mV<sub>pp</sub>

LED

0.07 kg / 18 x 90 x 61 mm  
Alignable: 0 mm horizontally, 30 mm vertically  
Screw connection  
0.2 - 2.5 mm<sup>2</sup> / 0.2 - 2.5 mm<sup>2</sup> / 24 - 12  
IP20 / II  
> 1860000 h (40°C)  
-25 °C ... 70 °C (> 55° C derating: 2.5%/K)

3.75 kV AC (routine test) / 4 kV AC (type test)  
Conformance with EMC Directive 2014/30/EU  
IEC 60950-1/VDE 0805 (SELV)  
EN 50178/VDE 0160 (PELV)  
DIN VDE 0100-410  
-  
UL/C-UL listed UL 508 , UL/C-UL Recognized UL 60950 ,  
NEC Class 2 as per UL 1310

EN 61000-3-2

Ordering data

Type	Order No.	Pcs./Pkt.
STEP-PS/48AC/24DC/0.5	2868716	1





Power supply,  
1 AC, 24 V DC, 100 W  
NEC Class 2

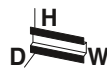

Power supply,  
1 AC, 24 V DC, 4.2 A



Power supply,  
1 AC, 24 V DC, 3.5 A  
Input up to 277 V AC, NEC Class 2

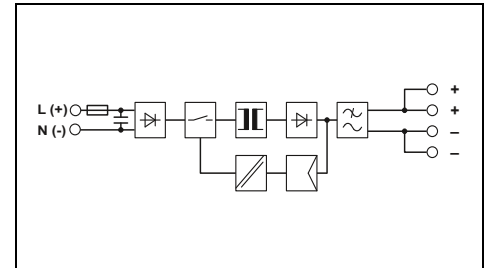
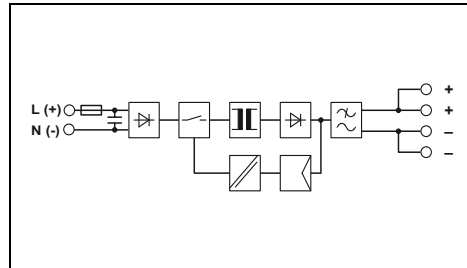
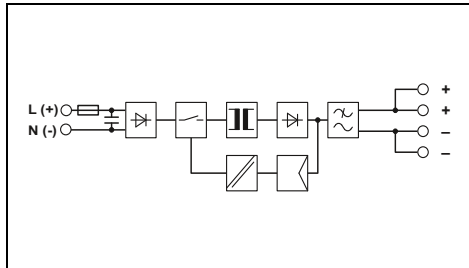

Technical data
100 V AC ... 240 V AC 85 V AC ... 264 V AC 95 V DC ... 250 V DC 45 Hz ... 65 Hz 1.3 A (120 V AC) / 0.8 A (230 V AC) < 15 A / < 1 A <sup>2</sup> s > 25 ms (120 V AC) / > 120 ms (230 V AC)
24 V DC ±1 % 22.5 V DC ... 25 V DC (> 24 V DC, constant capacity restricted)
3.8 A No / No < 0.7 W / 11.8 W > 88 % (for 230 V AC and nominal values) < 80 mV <sub>pp</sub>
LED
0.33 kg / 90 x 90 x 61 mm Alignable: 0 mm horizontally, 30 mm vertically Screw connection 0.2 - 2.5 mm <sup>2</sup> / 0.2 - 2.5 mm <sup>2</sup> / 24 - 12 IP20 / II > 897000 h (40°C) -25 °C ... 70 °C (> 55 °C derating: 2.5%/K)
3.75 kV AC (routine test) / 4 kV AC (type test) Conformance with EMC Directive 2014/30/EU IEC 60950-1/VDE 0805 (SELV) EN 50178/VDE 0160 (PELV) DIN VDE 0100-410 UL/C-UL listed UL 508 , UL/C-UL Recognized UL 60950 , UL ANSI/ISA-12.12.01 Class I, Division 2, Groups A, B, C, D (Hazardous Location) , NEC Class 2 as per UL 1310 EN 61000-3-2

Technical data
100 V AC ... 240 V AC 85 V AC ... 264 V AC 95 V DC ... 250 V DC 45 Hz ... 65 Hz / 0 Hz 1.3 A (120 V AC) / 0.8 A (230 V AC) < 15 A / < 1 A <sup>2</sup> s > 20 ms (120 V AC) / > 100 ms (230 V AC)
24 V DC ±1 % 22.5 V DC ... 29.5 V DC (> 24 V DC, constant capacity restricted)
4.2 A Yes / yes < 0.7 W / 13.2 W > 88 % (for 230 V AC and nominal values) < 40 mV <sub>pp</sub>
LED
0.33 kg / 90 x 90 x 61 mm Alignable: 0 mm horizontally, 30 mm vertically Screw connection 0.2 - 2.5 mm <sup>2</sup> / 0.2 - 2.5 mm <sup>2</sup> / 24 - 12 IP20 / II > 897000 h (40°C) -25 °C ... 70 °C (> 55 °C derating: 2.5%/K)
3.75 kV AC (routine test) / 4 kV AC (type test) Conformance with EMC Directive 2014/30/EU IEC 60950-1/VDE 0805 (SELV) EN 50178/VDE 0160 (PELV) DIN VDE 0100-410 UL/C-UL listed UL 508 , UL/C-UL Recognized UL 60950 , UL ANSI/ISA-12.12.01 Class I, Division 2, Groups A, B, C, D (Hazardous Location) EN 61000-3-2

Technical data
100 V AC ... 277 V AC 85 V AC ... 305 V AC 95 V DC ... 250 V DC 45 Hz ... 65 Hz / 0 Hz 1.43 A (120 V AC) / 0.75 A (277 V AC) < 40 A / < 2.8 A <sup>2</sup> s > 25 ms (120 V AC) / > 160 ms (277 V AC)
24 V DC ±1 % 22.5 V DC ... 25 V DC (> 24 V DC, constant capacity restricted)
3.5 A Yes / yes < 0.6 W / 11.5 W > 88 % (for 277 V AC and nominal values) < 10 mV <sub>pp</sub>
LED
0.3 kg / 90 x 90 x 61 mm Alignable: 0 mm horizontally, 30 mm vertically Screw connection 0.2 - 2.5 mm <sup>2</sup> / 0.2 - 2.5 mm <sup>2</sup> / 24 - 12 IP20 / II > 1094000 h (40°C) -25 °C ... 70 °C (> 55 °C derating: 2.5%/K)
3.75 kV AC (routine test) / 4 kV AC (type test) Conformance with EMC Directive 2014/30/EU IEC 60950-1/VDE 0805 (SELV) EN 50178/VDE 0160 (PELV) DIN VDE 0100-410 UL/C-UL listed UL 508 , UL/C-UL Recognized UL 60950 , NEC Class 2 as per UL 1310 EN 61000-3-2

Ordering data		
Type	Order No.	Pcs./Pkt.
STEP-PS/1AC/24DC/3.8/C2LPS	2868677	1

Ordering data		
Type	Order No.	Pcs./Pkt.
STEP-PS/1AC/24DC/4.2	2868664	1

Ordering data		
Type	Order No.	Pcs./Pkt.
STEP-PS/277AC/24DC/3.5	2904945	1

# Power supplies and UPS

## Power supplies

### STEP POWER power supplies – for installation distributors and flat control panels

#### STEP POWER, 1 AC, 5 to 48 V DC

- Flexible assembly by simply snapping the product onto the DIN rail or screwing it onto an even surface
- Energy savings thanks to maximum energy efficiency and incredibly low no-load losses
- Wide temperature range from -25°C to +70°C
- Reliable supply thanks to the high MTBF (mean time between failure)

#### STEP POWER, 5 V DC, 2 A

- Slim design with an overall width of just 18 mm (1 pitch)

#### STEP POWER, 5 V DC, 6.5 A

- Adjustable output voltage of 4 to 6.5 V DC

#### STEP POWER, 15 V DC, 4 A

- Adjustable output voltage of 10 to 16.5 V DC

#### STEP POWER, 48 V DC, 2 A

- Adjustable output voltage of 30 to 56 V DC



Power supply,  
1 AC, 5 V DC, 2 A  
NEC Class 2

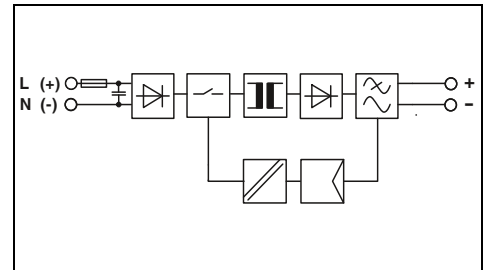

### Technical data

<b>Input data</b>	
Nominal input voltage range	100 V AC ... 240 V AC
Input voltage range	85 V AC ... 264 V AC 95 V DC ... 250 V DC
Frequency range	45 Hz ... 65 Hz / 0 Hz
Current consumption (nominal load)	0.2 A (120 V AC) / 0.13 A (230 V AC)
Inrush current limitation at 25°C / I <sub>t</sub>	< 15 A / < 0.1 A <sup>2</sup> s
Mains buffering (I <sub>N</sub> , typ.)	> 25 ms (120 V AC) / > 110 ms (230 V AC)
<b>Output data</b>	
Nominal output voltage	5 V DC ±1 %
Setting range of the output voltage (U <sub>set</sub> )	-
Output current	2 A
Can be connected in parallel/series	Yes / yes
Max. power dissipation (no load/nominal load)	< 0.4 W / < 2.6 W
Efficiency	> 81 % (for 230 V AC and nominal values)
Residual ripple	< 50 mV <sub>pp</sub>
<b>Signaling</b>	
Signaling DC OK	LED
<b>General data</b>	
Weight / Dimensions W x H x D	0.1 kg / 18 x 90 x 61 mm
Assembly instructions	Alignable: 0 mm horizontally, 30 mm vertically
Connection method	Screw connection
Connection data solid/stranded/AWG	0.2 - 2.5 mm <sup>2</sup> / 0.2 - 2.5 mm <sup>2</sup> / 24 - 12
Degree of protection / Protection class	IP20 / II
MTBF (IEC 61709, SN 29500)	> 1812000 h (40°C)
Ambient temperature (operation)	-25 °C ... 70 °C (> 55° C derating: 2.5%/K)
<b>Standards/regulations</b>	
Insulation voltage input/output	3.75 kV AC (routine test) / 4 kV AC (type test)
Electromagnetic compatibility	Conformance with EMC Directive 2014/30/EU
Electrical safety	IEC 60950-1/VDE 0805 (SELV)
Electronic equipm. for electrical power installations	EN 50178/VDE 0160 (PELV)
Safe isolation	DIN VDE 0100-410
UL approvals	UL/C-UL listed UL 508 , UL/C-UL Recognized UL 60950 , NEC Class 2 as per UL 1310
Limitation of harmonic line currents	EN 61000-3-2

### Ordering data

Description	Type	Order No.	Pcs./Pkt.
Power supply, primary-switched, 1-phase	STEP-PS/ 1AC/ 5DC/2	2320513	1



Power supply,  
1 AC, 5 V DC, 6.5 A



Power supply,  
1 AC, 15 V DC, 4 A



Power supply,  
1 AC, 48 V DC, 2 A

UL US ENEC ClassNK CB  
Ex:

UL US ENEC ClassNK CB  
Ex:

UL US ENEC ClassNK CB  
Ex:

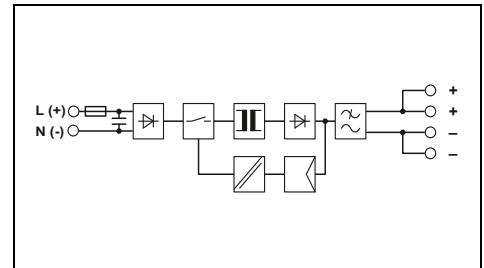
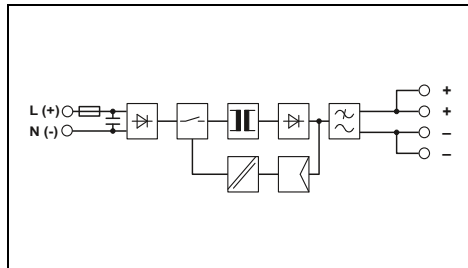
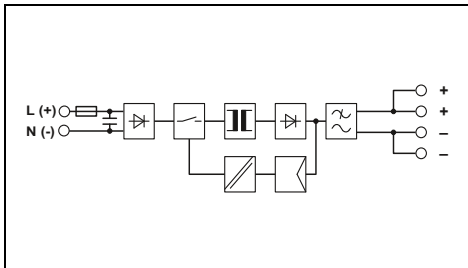

Technical data

100 V AC ... 240 V AC  
85 V AC ... 264 V AC  
95 V DC ... 250 V DC  
45 Hz ... 65 Hz / 0 Hz  
0.5 A (120 V AC) / 0.3 A (230 V AC)  
< 15 A / < 0.6 A<sup>2</sup>s  
> 25 ms (120 V AC) / > 140 ms (230 V AC)

5 V DC ±1 %  
4 V DC ... 6.5 V DC (> 5 V DC, constant capacity restricted)

6.5 A  
Yes / yes  
< 0.4 W / 8.1 W  
> 80 % (for 230 V AC and nominal values)  
< 50 mV<sub>pp</sub>

LED

0.27 kg / 72 x 90 x 61 mm  
Alignable: 0 mm horizontally, 30 mm vertically  
Screw connection  
0.2 - 2.5 mm<sup>2</sup> / 0.2 - 2.5 mm<sup>2</sup> / 24 - 12  
IP20 / II  
> 1111000 h (40°C)  
-25 °C ... 70 °C (> 55° C derating: 2.5%/K)

3.75 kV AC (routine test) / 4 kV AC (type test)  
Conformance with EMC Directive 2014/30/EU  
IEC 60950-1/VDE 0805 (SELV)  
EN 50178/VDE 0160 (PELV)  
DIN VDE 0100-410  
UL/C-UL listed UL 508 , UL/C-UL Recognized UL 60950 ,  
UL ANSI/ISA-12.12.01 Class I, Division 2, Groups A, B, C, D  
(Hazardous Location)  
EN 61000-3-2

Ordering data

Type	Order No.	Pcs./Pkt.
STEP-PS/ 1AC/ 5DC/6.5	2868541	1

Technical data

100 V AC ... 240 V AC  
85 V AC ... 264 V AC  
95 V DC ... 250 V DC  
45 Hz ... 65 Hz / 0 Hz  
0.8 A (120 V AC) / 0.5 A (230 V AC)  
< 15 A / < 0.6 A<sup>2</sup>s  
> 27 ms (120 V AC) / > 120 ms (230 V AC)

15 V DC ±1 %  
10 V DC ... 16.5 V DC (> 15 V DC, constant capacity restricted)

4 A  
Yes / yes  
< 0.5 W / 8.6 W  
> 87 % (for 230 V AC and nominal values)  
< 55 mV<sub>pp</sub>

LED

0.27 kg / 72 x 90 x 61 mm  
Alignable: 0 mm horizontally, 30 mm vertically  
Screw connection  
0.2 - 2.5 mm<sup>2</sup> / 0.2 - 2.5 mm<sup>2</sup> / 24 - 12  
IP20 / II  
> 1134000 h (40°C)  
-25 °C ... 70 °C (> 55° C derating: 2.5%/K)

3.75 kV AC (routine test) / 4 kV AC (type test)  
Conformance with EMC Directive 2014/30/EU  
IEC 60950-1/VDE 0805 (SELV)  
EN 50178/VDE 0160 (PELV)  
DIN VDE 0100-410  
UL/C-UL listed UL 508 , UL/C-UL Recognized UL 60950 ,  
UL ANSI/ISA-12.12.01 Class I, Division 2, Groups A, B, C, D  
(Hazardous Location)  
EN 61000-3-2

Ordering data

Type	Order No.	Pcs./Pkt.
STEP-PS/ 1AC/15DC/4	2868619	1

Technical data

100 V AC ... 240 V AC  
85 V AC ... 264 V AC  
95 V DC ... 250 V DC  
45 Hz ... 65 Hz / 0 Hz  
1.3 A (120 V AC) / 0.8 A (230 V AC)  
< 15 A / < 1.4 A<sup>2</sup>s  
> 20 ms (120 V AC) / > 120 ms (230 V AC)

48 V DC ±1 %  
30 V DC ... 56 V DC (> 48 V DC, constant capacity restricted)

2 A  
Yes / yes  
< 0.9 W / 9.6 W  
> 90 % (for 230 V AC and nominal values)  
< 30 mV<sub>pp</sub>

LED

0.33 kg / 90 x 90 x 61 mm  
Alignable: 0 mm horizontally, 30 mm vertically  
Screw connection  
0.2 - 2.5 mm<sup>2</sup> / 0.2 - 2.5 mm<sup>2</sup> / 24 - 12  
IP20 / II  
> 1048000 h (40°C)  
-25 °C ... 70 °C (> 55° C derating: 2.5%/K)

3.75 kV AC (routine test) / 4 kV AC (type test)  
Conformance with EMC Directive 2014/30/EU  
IEC 60950-1/VDE 0805 (SELV)  
EN 50178/VDE 0160 (PELV)  
DIN VDE 0100-410  
UL/C-UL listed UL 508 , UL/C-UL Recognized UL 60950 ,  
UL ANSI/ISA-12.12.01 Class I, Division 2, Groups A, B, C, D  
(Hazardous Location)  
EN 61000-3-2

Ordering data

Type	Order No.	Pcs./Pkt.
STEP-PS/ 1AC/48DC/2	2868680	1

# Power supplies and UPS

## Power supplies

### STEP POWER power supplies – for installation distributors and flat control panels

#### STEP POWER, 1 AC, 12 V DC

- Flexible assembly by simply snapping the product onto the DIN rail or screwing it onto an even surface
- Energy savings thanks to maximum energy efficiency and incredibly low no-load losses
- Wide temperature range from -25°C to +70°C
- Reliable supply thanks to the high MTBF (mean time between failure)

#### STEP POWER, 12 V DC, 1.5 A

- Meets standard EN 60335-1 for household appliances, suitable for installation in ventilation systems, for example



Power supply,  
1 AC, 12 V DC, 1 A  
NEC Class 2

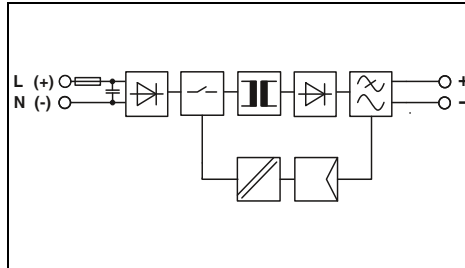

Power supply,  
1 AC, 12 V DC, 1.5 A  
Flat design, NEC Class 2

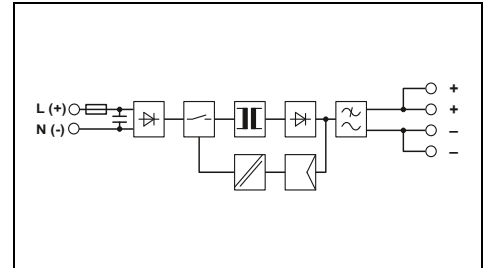

Input data	
Nominal input voltage range	100 V AC ... 240 V AC
Input voltage range	85 V AC ... 264 V AC 95 V DC ... 250 V DC
Frequency range	
Current consumption (nominal load)	45 Hz ... 65 Hz / 0 Hz
Inrush current limitation at 25°C / I <sub>pt</sub>	0.26 A (120 V AC) / 0.13 A (230 V AC)
Mains buffering (I <sub>N</sub> , typ.)	< 15 A / < 0.1 A <sup>2</sup> s > 15 ms (120 V AC) / > 90 ms (230 V AC)
Output data	
Nominal output voltage	12 V DC ± 1 %
Setting range of the output voltage (U <sub>set</sub> )	-
Output current	
Can be connected in parallel/series	1 A
Max. power dissipation (no load/nominal load)	Yes / yes < 0.4 W / < 2.8 W
Efficiency	> 83 % (for 230 V AC and nominal values)
Residual ripple	> 84 % (for 230 V AC and nominal values) < 20 mV <sub>pp</sub>
Signaling	
Signaling DC OK	LED
General data	
Weight / Dimensions W x H x D	0.07 kg / 18 x 90 x 61 mm
Assembly instructions	Alignable: 0 mm horizontally, 30 mm vertically
Connection method	Screw connection
Connection data solid/stranded/AWG	0.2 - 2.5 mm <sup>2</sup> / 0.2 - 2.5 mm <sup>2</sup> / 24 - 12
Degree of protection / Protection class	IP20 / II
MTBF (IEC 61709, SN 29500)	> 1478000 h (40°C)
Ambient temperature (operation)	-25 °C ... 70 °C (> 55 °C derating: 2.5%/K)
Standards/regulations	
Insulation voltage input/output	3.75 kV AC (routine test) / 4 kV AC (type test)
Electromagnetic compatibility	Conformance with EMC Directive 2014/30/EU
Electrical safety	IEC 60950-1/VDE 0805 (SELV)
Electronic equipm. for electrical power installations	EN 50178/VDE 0160 (PELV)
Safe isolation	DIN VDE 0100-410
Budgetary standard	-
UL approvals	UL/C-UL listed UL 508 , UL/C-UL Recognized UL 60950 , UL ANSI/ISA-12.12.01 Class I, Division 2, Groups A, B, C, D (Hazardous Location) , NEC Class 2 as per UL 1310 EN 61000-3-2
Limitation of harmonic line currents	

Technical data	
Nominal input voltage range	100 V AC ... 240 V AC
Input voltage range	85 V AC ... 264 V AC 95 V DC ... 250 V DC
Frequency range	
Current consumption (nominal load)	45 Hz ... 65 Hz / 0 Hz
Inrush current limitation at 25°C / I <sub>pt</sub>	0.26 A (120 V AC) / 0.13 A (230 V AC)
Mains buffering (I <sub>N</sub> , typ.)	< 15 A / < 0.1 A <sup>2</sup> s > 15 ms (120 V AC) / > 90 ms (230 V AC)
Output data	
Nominal output voltage	12 V DC ± 1 %
Setting range of the output voltage (U <sub>set</sub> )	-
Output current	
Can be connected in parallel/series	1 A
Max. power dissipation (no load/nominal load)	Yes / yes < 0.4 W / < 2.8 W
Efficiency	> 83 % (for 230 V AC and nominal values)
Residual ripple	> 84 % (for 230 V AC and nominal values) < 20 mV <sub>pp</sub>
Signaling	
Signaling DC OK	LED
General data	
Weight / Dimensions W x H x D	0.07 kg / 18 x 90 x 61 mm
Assembly instructions	Alignable: 0 mm horizontally, 30 mm vertically
Connection method	Screw connection
Connection data solid/stranded/AWG	0.2 - 2.5 mm <sup>2</sup> / 0.2 - 2.5 mm <sup>2</sup> / 24 - 12
Degree of protection / Protection class	IP20 / II
MTBF (IEC 61709, SN 29500)	> 1478000 h (40°C)
Ambient temperature (operation)	-25 °C ... 70 °C (> 55 °C derating: 2.5%/K)
Standards/regulations	
Insulation voltage input/output	3.75 kV AC (routine test) / 4 kV AC (type test)
Electromagnetic compatibility	Conformance with EMC Directive 2014/30/EU
Electrical safety	IEC 60950-1/VDE 0805 (SELV)
Electronic equipm. for electrical power installations	EN 50178/VDE 0160 (PELV)
Safe isolation	DIN VDE 0100-410
Budgetary standard	-
UL approvals	UL/C-UL listed UL 508 , UL/C-UL Recognized UL 60950 , UL ANSI/ISA-12.12.01 Class I, Division 2, Groups A, B, C, D (Hazardous Location) , NEC Class 2 as per UL 1310 EN 61000-3-2
Limitation of harmonic line currents	

Technical data	
Nominal input voltage range	100 V AC ... 240 V AC
Input voltage range	85 V AC ... 264 V AC 95 V DC ... 250 V DC
Frequency range	
Current consumption (nominal load)	45 Hz ... 65 Hz / 0 Hz
Inrush current limitation at 25°C / I <sub>pt</sub>	0.33 A (120 V AC) / 0.18 A (230 V AC)
Mains buffering (I <sub>N</sub> , typ.)	< 15 A / < 0.1 A <sup>2</sup> s > 15 ms (120 V AC) / > 70 ms (230 V AC)
Output data	
Nominal output voltage	12 V DC ± 1 %
Setting range of the output voltage (U <sub>set</sub> )	-
Output current	
Can be connected in parallel/series	1.5 A
Max. power dissipation (no load/nominal load)	Yes / yes < 0.4 W / < 3.2 W
Efficiency	> 84 % (for 230 V AC and nominal values)
Residual ripple	< 75 mV <sub>pp</sub>
Signaling	
Signaling DC OK	LED
General data	
Weight / Dimensions W x H x D	0.07 kg / 36 x 90 x 43 mm
Assembly instructions	Alignable: 0 mm horizontally, 30 mm vertically
Connection method	Screw connection
Connection data solid/stranded/AWG	0.2 - 2.5 mm <sup>2</sup> / 0.2 - 2.5 mm <sup>2</sup> / 24 - 12
Degree of protection / Protection class	IP20 / II
MTBF (IEC 61709, SN 29500)	> 1800000 h (40°C)
Ambient temperature (operation)	-25 °C ... 70 °C (> 55 °C derating: 2.5%/K)
Standards/regulations	
Insulation voltage input/output	3.75 kV AC (routine test) / 4 kV AC (type test)
Electromagnetic compatibility	Conformance with EMC Directive 2014/30/EU
Electrical safety	IEC 60950-1/VDE 0805 (SELV)
Electronic equipm. for electrical power installations	EN 50178/VDE 0160 (PELV)
Safe isolation	DIN VDE 0100-410
Budgetary standard	IEC 60335-1
UL approvals	UL/C-UL listed UL 508 , UL/C-UL Recognized UL 60950 , UL ANSI/ISA-12.12.01 Class I, Division 2, Groups A, B, C, D (Hazardous Location) , NEC Class 2 as per UL 1310 EN 61000-3-2
Limitation of harmonic line currents	

Ordering data	
Description	Type
Power supply, primary-switched	STEP-PS/ 1AC/12DC/1

Ordering data		
Type	Order No.	Pcs./Pkt.
STEP-PS/ 1AC/12DC/1	2868538	1

Ordering data			
Description	Type	Order No.	Pcs./Pkt.
Power supply, primary-switched	STEP-PS/ 1AC/12DC/1.5/FL	2868554	1



Power supply,  
1 AC, 12 V DC, 1.5 A  
NEC Class 2

UL US ENEC ClassNK CB  
Ex:



Power supply,  
1 AC, 12 V DC, 3 A  
NEC Class 2

UL US ENEC ClassNK CB  
Ex:



Power supply,  
1 AC, 12 V DC, 5 A

UL US ENEC ClassNK CB  
Ex:

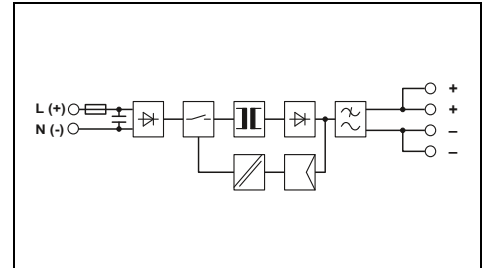
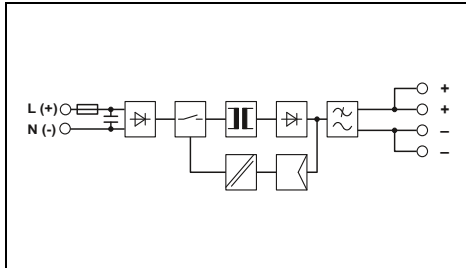
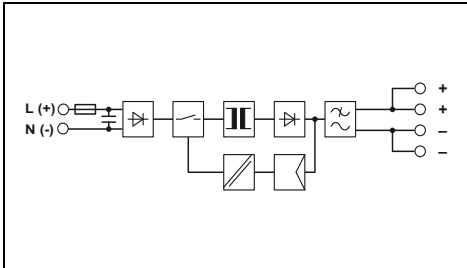

Technical data

100 V AC ... 240 V AC  
85 V AC ... 264 V AC  
95 V DC ... 250 V DC  
45 Hz ... 65 Hz / 0 Hz  
0.3 A (120 V AC) / 0.2 A (230 V AC)  
< 15 A / < 0.1 A<sup>2</sup>s  
> 15 ms (120 V AC) / > 70 ms (230 V AC)

12 V DC ±1 %  
-

1.5 A  
Yes / yes  
< 0.4 W / < 3.2 W  
> 84 % (for 230 V AC and nominal values)  
< 75 mV<sub>pp</sub>

LED

0.11 kg / 36 x 90 x 61 mm  
Alignable: 0 mm horizontally, 30 mm vertically  
Screw connection  
0.2 - 2.5 mm<sup>2</sup> / 0.2 - 2.5 mm<sup>2</sup> / 24 - 12  
IP20 / II  
> 1800000 h (40°C)  
-25 °C ... 70 °C (> 55° C derating: 2.5%/K)

3.75 kV AC (routine test) / 4 kV AC (type test)  
Conformance with EMC Directive 2014/30/EU  
IEC 60950-1/VDE 0805 (SELV)  
EN 50178/VDE 0160 (PELV)  
DIN VDE 0100-410  
IEC 60335-1  
UL/C-UL listed UL 508 , UL/C-UL Recognized UL 60950 ,  
UL ANSI/ISA-12.12.01 Class I, Division 2, Groups A, B, C, D  
(Hazardous Location) , NEC Class 2 as per UL 1310  
EN 61000-3-2

Ordering data

Type	Order No.	Pcs./Pkt.
STEP-PS/ 1AC/12DC/1.5	2868567	1

Technical data

100 V AC ... 240 V AC  
85 V AC ... 264 V AC  
95 V DC ... 250 V DC  
45 Hz ... 65 Hz / 0 Hz  
0.6 A (120 V AC) / 0.3 A (230 V AC)  
< 15 A / < 0.6 A<sup>2</sup>s  
> 26 ms (120 V AC) / > 160 ms (230 V AC)

12 V DC ±1 %  
10 V DC ... 16.5 V DC (> 12 V DC, constant capacity restricted)

3 A  
Yes / yes  
< 0.5 W / 6.4 W  
> 85 % (for 230 V AC and nominal values)  
< 40 mV<sub>pp</sub>

LED

0.19 kg / 54 x 90 x 61 mm  
Alignable: 0 mm horizontally, 30 mm vertically  
Screw connection  
0.2 - 2.5 mm<sup>2</sup> / 0.2 - 2.5 mm<sup>2</sup> / 24 - 12  
IP20 / II  
> 1689000 h (40°C)  
-25 °C ... 70 °C (> 55° C derating: 2.5%/K)

3.75 kV AC (routine test) / 4 kV AC (type test)  
Conformance with EMC Directive 2014/30/EU  
IEC 60950-1/VDE 0805 (SELV)  
EN 50178/VDE 0160 (PELV)  
DIN VDE 0100-410  
-  
UL/C-UL listed UL 508 , UL/C-UL Recognized UL 60950 ,  
UL ANSI/ISA-12.12.01 Class I, Division 2, Groups A, B, C, D  
(Hazardous Location) , NEC Class 2 as per UL 1310  
EN 61000-3-2

Ordering data

Type	Order No.	Pcs./Pkt.
STEP-PS/ 1AC/12DC/3	2868570	1

Technical data

100 V AC ... 240 V AC  
85 V AC ... 264 V AC  
95 V DC ... 250 V DC  
45 Hz ... 65 Hz / 0 Hz  
0.8 A (120 V AC) / 0.5 A (230 V AC)  
< 15 A / < 0.6 A<sup>2</sup>s  
> 27 ms (120 V AC) / > 120 ms (230 V AC)

12 V DC ±1 %  
10 V DC ... 16.5 V DC (> 12 V DC, constant capacity restricted)

5 A  
Yes / yes  
< 0.5 W / 8.6 W  
> 87 % (for 230 V AC and nominal values)  
< 55 mV<sub>pp</sub>

LED

0.27 kg / 72 x 90 x 61 mm  
Alignable: 0 mm horizontally, 30 mm vertically  
Screw connection  
0.2 - 2.5 mm<sup>2</sup> / 0.2 - 2.5 mm<sup>2</sup> / 24 - 12  
IP20 / II  
> 1134000 h (40°C)  
-25 °C ... 70 °C (> 55° C derating: 2.5%/K)

3.75 kV AC (routine test) / 4 kV AC (type test)  
Conformance with EMC Directive 2014/30/EU  
IEC 60950-1/VDE 0805 (SELV)  
EN 50178/VDE 0160 (PELV)  
DIN VDE 0100-410  
-  
UL/C-UL listed UL 508 , UL/C-UL Recognized UL 60950 ,  
UL ANSI/ISA-12.12.01 Class I, Division 2, Groups A, B, C, D  
(Hazardous Location)  
EN 61000-3-2

Ordering data

Type	Order No.	Pcs./Pkt.
STEP-PS/ 1AC/12DC/5	2868583	1



**QUINT and MINI DC/DC converters alter the voltage level, regenerate the voltage at the end of long cables, or enable the creation of independent supply systems by means of electrical isolation.**

There are numerous fields of application for DC/DC converters. As the name suggests, they convert voltages in order to match different voltage levels to one another. On long supply lines, they raise the voltage to compensate for voltage drops.

DC/DC converters separate circuits from each other by means of electrical isolation and protect the sensitive loads by decoupling them. The primary-switched switching devices have an internal intermediate circuit. This acts as a filter. This means, for example, that grounded and non-grounded circuits can be kept separate. Another advantage is the protection of critical loads from disruptive voltage fluctuations: if, for example, a motor is switched on that requires a high current for the starting torque, there is a brief voltage dip and sensitive loads shut down. The same occurs when loads with high input capacities are switched on. Troubleshooting these temporary faults is often difficult and time-consuming.

DC/DC converters are also ideal in battery-supported power supply networks or solutions with unregulated transformers, when sensitive loads require a stable DC.

### QUINT POWER – maximum functionality

Cost-effective selective fuse protection with SFB Technology:

In order to trip miniature circuit breakers magnetically and quickly, power supplies must be able to supply several times the nominal current for a short period. With SFB (Selective Fuse Breaking) Technology, which supplies up to 6 times the nominal current for 12 ms, a dynamic power reserve is available. Faulty current paths are switched off selectively, the fault is located, and important system parts remain in operation.

#### Preventive function monitoring:

Comprehensive diagnostics are provided through constant monitoring of the input voltage, output voltage, and output current. This preventive monitoring visualizes critical operating states, before errors can occur. Remote monitoring is provided by means of active switching outputs and floating relay contacts.

#### Power Boost power reserve:

The static power reserve offers up to 1.25 times the nominal current permanently. At ambient temperatures of up to +40°C the Power Boost is continuously available and at higher temperatures it is available for a few minutes. This ensures that both high switch-on currents of capacitive loads, as well as loads with DC/DC converters in the primary circuit can be reliably supplied.

**📄 Your web code: #0152**



### QUINT POWER

The unique SFB Technology and preventive function monitoring maximize the availability of your application.

- Quick tripping of standard circuit breakers with SFB Technology
- Preventive function monitoring
- Reliable starting of heavy loads with Power Boost

### QUINT POWER CO with protective coating for extreme requirements

The protective coating on these DC/DC converters protects against dust, corrosive gases, and 100% humidity as well as failure caused by corrosion-related creepage currents and electrochemical migration.

- OVP (overvoltage protection) limits surge voltages to 32 V
- Wide temperature range from -40°C to +70°C

### MINI DC/DC converters – for control technology

MINI DC/DC converters come into their own in fields where modular electronics housing has become the standard.

- Maintenance-friendly connection technology with coded COMBICON connectors
- Active function monitoring with switching output for remote monitoring of the output voltage

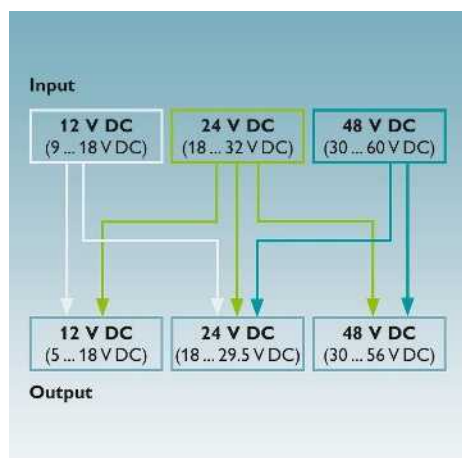

### Voltage levels of QUINT DC/DC converters with 12 to 48 V DC

The QUINT DC/DC converters alter the voltage level:

- Input voltages:
  - 12 V DC (9 ... 18 V DC),
  - 24 V DC (18 ... 32 V DC),
  - 48 V DC (30 ... 60 V DC)
- Output voltages:
  - 12 V DC (5 ... 18 V DC),
  - 24 V DC (18 ... 29.5 V DC),
  - 48 V DC (30 ... 56 V DC)

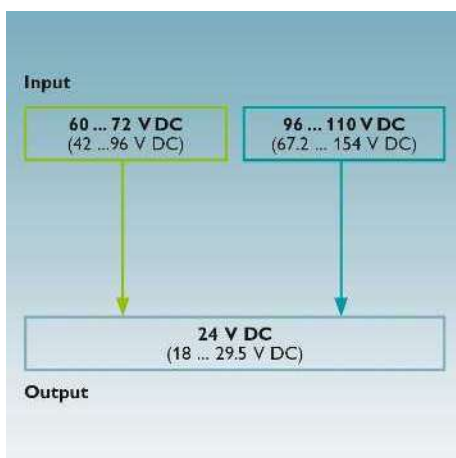

### Voltage levels of QUINT DC/DC converters with 60 to 110 V DC

The QUINT DC/DC converters alter the voltage level:

- Input voltages:
  - 60 to 72 V DC (42 ... 96 V DC),
  - 96 to 110 V DC (67 ... 154 V DC)
- Output voltages:
  - 24 V DC (18 ... 29.5 V DC)

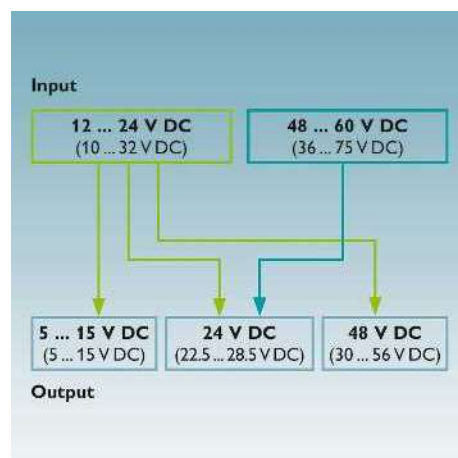

### Voltage levels of MINI DC/DC converters

The MINI DC/DC converters alter the voltage level:

- Input voltages:
  - 12 to 24 V DC (10 ... 32 V DC),
  - 48 to 60 V DC (36 ... 75 V DC)
- Output voltages:
  - 5 to 15 V DC (5 ... 15 V DC),
  - 24 V DC (22.5 ... 28.5 V DC),
  - 48 V DC (30 ... 56 V DC)

# Power supplies and UPS

## DC/DC converters

### QUINT DC/DC converters

#### QUINT POWER, 24 V DC input

- Support conversion to various voltage levels
- Constant voltage: output voltage regenerated even at the end of long cables
- Electrical isolation: for setting up independent supply systems
- SFB Technology: fast tripping of standard circuit breakers, thanks to the dynamic power reserve with up to 6 times the nominal current for 12 ms
- Reliable starting of heavy loads thanks to the static Power Boost power reserve with up to 125% of the nominal current
- Preventive function monitoring



DC/DC converter,  
24 V DC / 24 V DC, 5 A

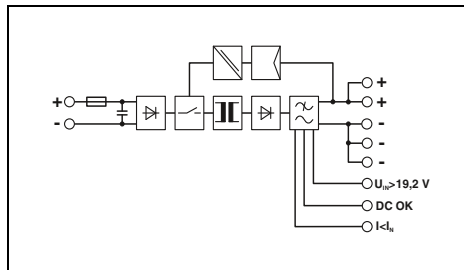

#### Technical data

Input data	24 V DC
Nominal input voltage range	7 A (24 V, I <sub>BOOST</sub> )
Current consumption (Power Boost)	< 15 A / < 0.5 A <sup>2</sup> s
Inrush current limitation at 25°C / I <sup>2</sup> t	> 10 ms (24 V DC)
Mains buffering (I <sub>N</sub> , typ.)	
Output data	24 V DC ±1 %
Nominal output voltage	18 V DC ... 29.5 V DC (> 24 V DC, constant capacity restricted)
Setting range of the output voltage (U <sub>set</sub> )	
Output current / Power Boost / SFB (12 ms)	5 A / 6.25 A / 30 A
Magnetic circuit breaker tripping	B2 / B4 / C2
Can be connected in parallel/series	Yes / yes
Max. power dissipation (no load/nominal load)	2.4 W / 11.4 W
Efficiency	> 92 %
Residual ripple	< 20 mV <sub>pp</sub>
Signaling	
Signaling DC OK	LED, active switching output
Boost signaling	LED, active switching output
U <sub>N</sub> signaling	LED, active switching output
General data	
Weight / Dimensions W x H x D	0.7 kg / 32 x 130 x 125 mm
Assembly instructions	Alignable: 5 mm horizontally, 15 mm next to active components, 50 mm vertically
Connection method	Plug-in screw connection
Input connection data (solid/stranded/AWG)	0.2 - 2.5 mm <sup>2</sup> / 0.2 - 2.5 mm <sup>2</sup> / 24 - 12
Output connection data (solid/stranded/AWG)	0.2 - 2.5 mm <sup>2</sup> / 0.2 - 2.5 mm <sup>2</sup> / 24 - 12
Signal connection data (solid/stranded/AWG)	0.2 - 2.5 mm <sup>2</sup> / 0.2 - 2.5 mm <sup>2</sup> / 24 - 12
Degree of protection / Protection class	IP20 / III
MTBF (IEC 61709, SN 29500)	> 890000 h (40°C)
Ambient temperature (operation)	-25 °C ... 70 °C (> 60 °C derating: 2.5%/K, startup at -40°C type-tested)
Max. permissible relative humidity (operation)	≤ 95 % (at 25 °C, non-condensing)
Standards/regulations	
Insulation voltage input/output	1 kV (routine test) / 1.5 kV (type test)
Electromagnetic compatibility	Conformance with EMC Directive 2014/30/EU
Electrical safety	EN 60950-1/VDE 0805 (SELV)
Electronic eqpm. for electrical power installations	EN 50178/VDE 0160 (PELV)
Safe isolation	DIN VDE 0100-410
UL approvals	UL/C-UL listed UL 508 , UL/C-UL Recognized UL 60950 , UL ANSI/ISA-12.12.01 Class I, Division 2, Groups A, B, C, D (Hazardous Location)



DC/DC converter,  
24 V DC / 24 V DC, 10 A

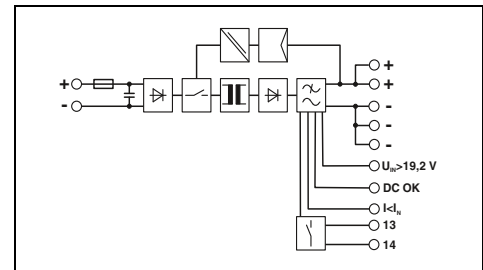

#### Technical data

Input data	24 V DC
Nominal input voltage range	14 A (24 V, I <sub>BOOST</sub> )
Current consumption (Power Boost)	< 15 A / < 2.7 A <sup>2</sup> s
Inrush current limitation at 25°C / I <sup>2</sup> t	> 12 ms (24 V DC)
Mains buffering (I <sub>N</sub> , typ.)	
Output data	24 V DC ±1 %
Nominal output voltage	18 V DC ... 29.5 V DC (> 24 V DC, constant capacity restricted)
Setting range of the output voltage (U <sub>set</sub> )	
Output current / Power Boost / SFB (12 ms)	10 A / 12.5 A / 60 A
Magnetic circuit breaker tripping	B2 / B4 / B6 / C2 / C4
Can be connected in parallel/series	Yes / yes
Max. power dissipation (no load/nominal load)	1.6 W / 24 W
Efficiency	> 92 %
Residual ripple	< 20 mV <sub>pp</sub>
Signaling	
Signaling DC OK	LED, active switching output, relay contact
Boost signaling	LED, active switching output
U <sub>N</sub> signaling	LED, active switching output
General data	
Weight / Dimensions W x H x D	0.9 kg / 48 x 130 x 125 mm
Assembly instructions	Alignable: 5 mm horizontally, 15 mm next to active components, 50 mm vertically
Connection method	Plug-in screw connection
Input connection data (solid/stranded/AWG)	0.2 - 2.5 mm <sup>2</sup> / 0.2 - 2.5 mm <sup>2</sup> / 24 - 12
Output connection data (solid/stranded/AWG)	0.2 - 2.5 mm <sup>2</sup> / 0.2 - 2.5 mm <sup>2</sup> / 24 - 12
Signal connection data (solid/stranded/AWG)	0.2 - 2.5 mm <sup>2</sup> / 0.2 - 2.5 mm <sup>2</sup> / 24 - 12
Degree of protection / Protection class	IP20 / III
MTBF (IEC 61709, SN 29500)	> 763000 h (40°C)
Ambient temperature (operation)	-25 °C ... 70 °C (> 60 °C derating: 2.5%/K)
Max. permissible relative humidity (operation)	≤ 95 % (at 25 °C, non-condensing)
Standards/regulations	
Insulation voltage input/output	1 kV (routine test) / 1.5 kV (type test)
Electromagnetic compatibility	Conformance with EMC Directive 2014/30/EU
Electrical safety	EN 60950-1/VDE 0805 (SELV)
Electronic eqpm. for electrical power installations	EN 50178/VDE 0160 (PELV)
Safe isolation	DIN VDE 0100-410
UL approvals	UL/C-UL listed UL 508 , UL/C-UL Recognized UL 60950 , UL ANSI/ISA-12.12.01 Class I, Division 2, Groups A, B, C, D (Hazardous Location)

#### Ordering data

Description	Type	Order No.	Pcs./Pkt.
DC/DC converter, primary-switched	QUINT-PS/24DC/24DC/5	2320034	1

#### Ordering data

Description	Type	Order No.	Pcs./Pkt.
DC/DC converter, primary-switched	QUINT-PS/24DC/24DC/10	2320092	1



DC/DC converter,  
24 V DC / 24 V DC, 20 A



DC/DC converter,  
24 V DC / 12 V DC, 8 A

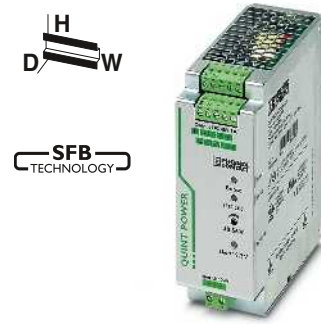

DC/DC converter,  
24 V DC / 48 V DC, 5 A

UL US ENEC CE CB ClassNK  
Ex:

UL US ENEC CE CB ClassNK  
Ex:

UL US ENEC CE CB ClassNK  
Ex:

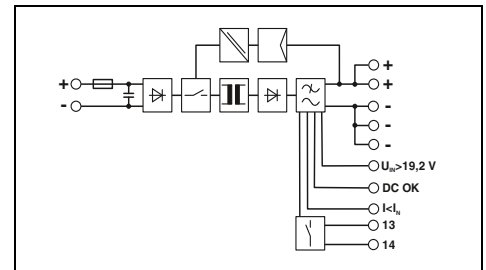
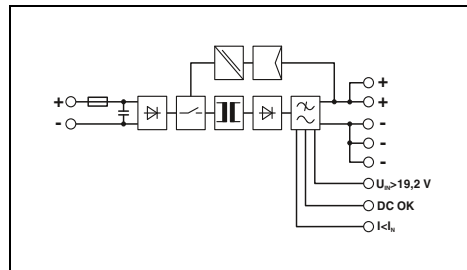
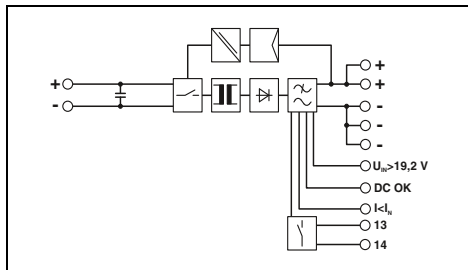

Technical data

Technical data

Technical data

24 V DC  
28 A (24 V, I<sub>BOOST</sub>)  
< 26 A / < 11 A<sup>2</sup>s  
> 10 ms (24 V DC)

24 V DC  
6 A (24 V, I<sub>BOOST</sub>)  
< 15 A / < 0.5 A<sup>2</sup>s  
> 10 ms (24 V DC)

24 V DC  
14 A (24 V, I<sub>BOOST</sub>)  
< 15 A / 3 A<sup>2</sup>s  
> 12 ms (24 V DC)

24 V DC ±1 %  
18 V DC ... 29.5 V DC (> 24 V DC, constant capacity restricted)

12 V DC ±1 %  
5 V DC ... 18 V DC (> 12 V DC, constant capacity restricted)

48 V DC ±1 %  
30 V DC ... 56 V DC (> 48 V DC, constant capacity restricted)

20 A / 25 A / 120 A  
B2 / B4 / B6 / B10 / B16 / C2 / C4 / C6  
Yes / yes  
2.2 W / 39 W  
> 93 %  
< 20 mV<sub>PP</sub>

8 A / 10 A / 48 A  
B2 / B4 / C2  
Yes / yes  
2 W / 10.5 W  
> 90 %  
< 20 mV<sub>PP</sub>

5 A / 6.25 A / 30 A  
B2 / B4 / C2  
Yes / yes  
5.2 W / 21 W  
> 92.5 %  
< 20 mV<sub>PP</sub>

LED, active switching output, relay contact  
LED, active switching output  
LED, active switching output

LED, active switching output  
LED, active switching output  
LED, active switching output

LED, active switching output, relay contact  
LED, active switching output  
LED, active switching output

1.7 kg / 82 x 130 x 125 mm  
Alignable: 5 mm horizontally, 15 mm next to active components, 50 mm vertically  
Screw connection  
0.5 - 16 mm<sup>2</sup> / 0.5 - 16 mm<sup>2</sup> / 8 - 6  
0.2 - 6 mm<sup>2</sup> / 0.2 - 4 mm<sup>2</sup> / 12 - 10  
0.2 - 2.5 mm<sup>2</sup> / 0.2 - 2.5 mm<sup>2</sup> / 24 - 12  
IP20 / III  
> 554000 h (40°C)  
-25 °C ... 70 °C (> 60 °C derating: 2.5%/K, startup at -40°C type-tested)  
≤ 95 % (at 25 °C, non-condensing)

0.7 kg / 32 x 130 x 125 mm  
Alignable: 5 mm horizontally, 15 mm next to active components, 50 mm vertically  
Plug-in screw connection  
0.2 - 2.5 mm<sup>2</sup> / 0.2 - 2.5 mm<sup>2</sup> / 24 - 12  
0.2 - 2.5 mm<sup>2</sup> / 0.2 - 2.5 mm<sup>2</sup> / 24 - 12  
0.2 - 2.5 mm<sup>2</sup> / 0.2 - 2.5 mm<sup>2</sup> / 24 - 12  
IP20 / III  
> 843000 h (40°C)  
-25 °C ... 70 °C (> 60 °C derating: 2.5%/K, startup at -40°C type-tested)  
≤ 95 % (at 25 °C, non-condensing)

0.9 kg / 48 x 130 x 125 mm  
Alignable: 5 mm horizontally, 15 mm next to active components, 50 mm vertically  
Plug-in screw connection  
0.2 - 2.5 mm<sup>2</sup> / 0.2 - 2.5 mm<sup>2</sup> / 24 - 12  
0.2 - 2.5 mm<sup>2</sup> / 0.2 - 2.5 mm<sup>2</sup> / 24 - 12  
0.2 - 2.5 mm<sup>2</sup> / 0.2 - 2.5 mm<sup>2</sup> / 24 - 12  
IP20 / III  
> 761000 h (40°C)  
-25 °C ... 70 °C (> 60 °C derating: 2.5%/K, startup at -40°C type-tested)  
≤ 95 % (at 25 °C, non-condensing)

1 kV (routine test) / 1.5 kV (type test)  
Conformance with EMC Directive 2014/30/EU  
EN 60950-1/VDE 0805 (SELV)  
EN 50178/VDE 0160 (PELV)  
DIN VDE 0100-410  
UL/C-UL listed UL 508 , UL/C-UL Recognized UL 60950 ,  
UL ANSI/ISA-12.12.01 Class I, Division 2, Groups A, B, C, D  
(Hazardous Location)

1 kV (routine test) / 1.5 kV (type test)  
Conformance with EMC Directive 2014/30/EU  
EN 60950-1/VDE 0805 (SELV)  
EN 50178/VDE 0160 (PELV)  
DIN VDE 0100-410  
UL/C-UL listed UL 508 , UL/C-UL Recognized UL 60950 ,  
UL ANSI/ISA-12.12.01 Class I, Division 2, Groups A, B, C, D  
(Hazardous Location)

1 kV (routine test) / 1.5 kV (type test)  
Conformance with EMC Directive 2014/30/EU  
EN 60950-1/VDE 0805 (SELV)  
EN 50178/VDE 0160 (PELV)  
DIN VDE 0100-410  
UL/C-UL listed UL 508 , UL/C-UL Recognized UL 60950 ,  
UL ANSI/ISA-12.12.01 Class I, Division 2, Groups A, B, C, D  
(Hazardous Location)

Ordering data

Ordering data

Ordering data

Type	Order No.	Pcs./Pkt.
QUINT-PS/24DC/24DC/20	2320102	1

Type	Order No.	Pcs./Pkt.
QUINT-PS/24DC/12DC/ 8	2320115	1

Type	Order No.	Pcs./Pkt.
QUINT-PS/24DC/48DC/ 5	2320128	1

#### QUINT POWER, 12 V DC input

- Support conversion to various voltage levels
- Constant voltage: output voltage regenerated even at the end of long cables
- Electrical isolation: for setting up independent supply systems
- SFB Technology: fast tripping of standard circuit breakers, thanks to the dynamic power reserve with up to 6 times the nominal current for 12 ms
- Reliable starting of heavy loads thanks to the static Power Boost power reserve with up to 125% of the nominal current
- Preventive function monitoring



**DC/DC converter,  
12 V DC / 24 V DC, 5 A**

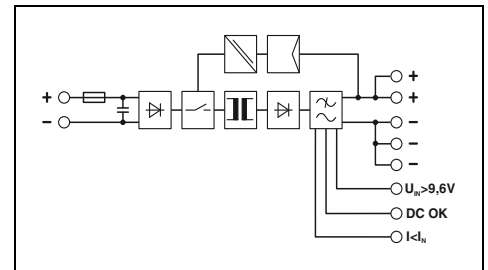

<b>Input data</b>	
Nominal input voltage range	12 V DC
Current consumption (Power Boost)	15 A (12 V, I <sub>BOOST</sub> )
Inrush current limitation at 25°C / I <sub>t</sub>	< 15 A / < 0.3 A <sup>2</sup> s
Mains buffering (I <sub>N</sub> , typ.)	> 3 ms (12 V DC)
<b>Output data</b>	
Nominal output voltage	24 V DC ± 1 %
Setting range of the output voltage (U <sub>Set</sub> )	18 V DC ... 29.5 V DC (> 24 V DC, constant capacity restricted)
Output current / Power Boost / SFB (12 ms)	5 A / 6.25 A / 30 A
Magnetic circuit breaker tripping	B2 / B4 / C2
Can be connected in parallel/series	Yes / yes
Max. power dissipation (no load/nominal load)	2 W / 13.5 W
Efficiency	> 90 %
Residual ripple	< 75 mV <sub>PP</sub>
<b>Signaling</b>	
Signaling DC OK	LED, active switching output
Boost signaling	LED, active switching output
U <sub>N</sub> signaling	LED, active switching output
<b>General data</b>	
Weight / Dimensions W x H x D	0.7 kg / 32 x 130 x 125 mm
Assembly instructions	Alignable: 5 mm horizontally, 15 mm next to active components, 50 mm vertically
Connection method	Plug-in screw connection
Input connection data (solid/stranded/AWG)	0.2 - 2.5 mm <sup>2</sup> / 0.2 - 2.5 mm <sup>2</sup> / 18 - 12
Output connection data (solid/stranded/AWG)	0.2 - 2.5 mm <sup>2</sup> / 0.2 - 2.5 mm <sup>2</sup> / 18 - 12
Signal connection data (solid/stranded/AWG)	0.2 - 2.5 mm <sup>2</sup> / 0.2 - 2.5 mm <sup>2</sup> / 24 - 12
Degree of protection / Protection class	IP20 / III
MTBF (IEC 61709, SN 29500)	> 1005000 h (40°C)
Ambient temperature (operation)	-25 °C ... 70 °C (> 60 °C derating: 2.5%/K)
Max. permissible relative humidity (operation)	≤ 95 % (at 25 °C, non-condensing)
<b>Standards/regulations</b>	
Insulation voltage input/output	1 kV (routine test) / 1.5 kV (type test)
Electromagnetic compatibility	Conformance with EMC Directive 2014/30/EU
Electrical safety	EN 60950-1/VDE 0805 (SELV)
Electronic equipm. for electrical power installations	EN 50178/VDE 0160 (PELV)
Safe isolation	DIN VDE 0100-410
UL approvals	UL/C-UL listed UL 508 , UL/C-UL Recognized UL 60950 , UL ANSI/ISA-12.12.01 Class I, Division 2, Groups A, B, C, D (Hazardous Location)

#### Technical data

<b>Technical data</b>		
12 V DC		
15 A (12 V, I <sub>BOOST</sub> )		
< 15 A / < 0.3 A <sup>2</sup> s		
> 3 ms (12 V DC)		
24 V DC ± 1 %		
18 V DC ... 29.5 V DC (> 24 V DC, constant capacity restricted)		
5 A / 6.25 A / 30 A		
B2 / B4 / C2		
Yes / yes		
2 W / 13.5 W		
> 90 %		
< 75 mV <sub>PP</sub>		
LED, active switching output		
LED, active switching output		
LED, active switching output		
0.7 kg / 32 x 130 x 125 mm		
Alignable: 5 mm horizontally, 15 mm next to active components, 50 mm vertically		
Plug-in screw connection		
0.2 - 2.5 mm <sup>2</sup> / 0.2 - 2.5 mm <sup>2</sup> / 18 - 12		
0.2 - 2.5 mm <sup>2</sup> / 0.2 - 2.5 mm <sup>2</sup> / 18 - 12		
0.2 - 2.5 mm <sup>2</sup> / 0.2 - 2.5 mm <sup>2</sup> / 24 - 12		
IP20 / III		
> 1005000 h (40°C)		
-25 °C ... 70 °C (> 60 °C derating: 2.5%/K)		
≤ 95 % (at 25 °C, non-condensing)		
1 kV (routine test) / 1.5 kV (type test)		
Conformance with EMC Directive 2014/30/EU		
EN 60950-1/VDE 0805 (SELV)		
EN 50178/VDE 0160 (PELV)		
DIN VDE 0100-410		
UL/C-UL listed UL 508 , UL/C-UL Recognized UL 60950 , UL ANSI/ISA-12.12.01 Class I, Division 2, Groups A, B, C, D (Hazardous Location)		

#### Ordering data

Description	<b>DC/DC converter, primary-switched</b>
-------------	--

Type	Order No.	Pcs./Pkt.
QUINT-PS/12DC/24DC/ 5	2320131	1



DC/DC converter,  
12 V DC/12 V DC, 8 A

ERC  
Ex:

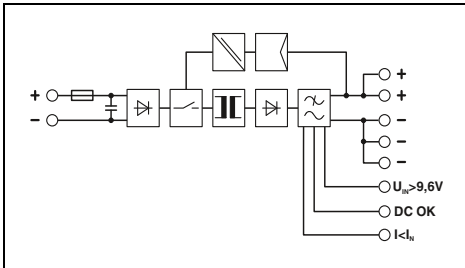

#### Technical data

12 V DC  
12 A (12 V, I<sub>BOOST</sub>)  
< 6 A / < 0.6 A<sup>2</sup>s  
> 3 ms (12 V DC)

12 V DC ±1 %  
5 V DC ... 18 V DC (> 12 V DC, constant capacity restricted)

8 A / 10 A / 48 A  
B2 / B4 / C2  
Yes / yes  
1.5 W / 11.8 W  
> 89 %  
< 20 mV<sub>pp</sub>

LED, active switching output  
LED, active switching output  
LED, active switching output

0.8 kg / 32 x 130 x 125 mm  
Alignable: 5 mm horizontally, 15 mm next to active components,  
50 mm vertically  
Plug-in screw connection  
0.2 - 2.5 mm<sup>2</sup> / 0.2 - 2.5 mm<sup>2</sup> / 24 - 12  
0.2 - 2.5 mm<sup>2</sup> / 0.2 - 2.5 mm<sup>2</sup> / 24 - 12  
0.2 - 2.5 mm<sup>2</sup> / 0.2 - 2.5 mm<sup>2</sup> / 24 - 12  
IP20 / III  
> 920000 h (40°C)  
-25 °C ... 70 °C (> 60 °C derating: 2.5%/K)  
≤ 95 % (at 25 °C, non-condensing)

1 kV (routine test) / 1.5 kV (type test)  
Conformance with EMC Directive 2014/30/EU  
EN 60950-1/VDE 0805 (SELV)  
EN 50178/VDE 0160 (PELV)  
DIN VDE 0100-410  
UL/C-UL listed UL 508 , UL/C-UL Recognized UL 60950 ,  
UL ANSI/ISA-12.12.01 Class I, Division 2, Groups A, B, C, D  
(Hazardous Location)

#### Ordering data

Type	Order No.	Pcs./Pkt.
QUINT-PS/12DC/12DC/8	2905007	1

#### QUINT POWER, 48 V DC to 110 V DC input

- Support conversion to various voltage levels
- Constant voltage: output voltage regenerated even at the end of long cables
- Electrical isolation: for setting up independent supply systems
- SFB Technology: fast tripping of standard circuit breakers, thanks to the dynamic power reserve with up to 6 times the nominal current for 12 ms
- Reliable starting of heavy loads thanks to the static Power Boost power reserve with up to 125% of the nominal current
- Preventive function monitoring



**DC/DC converter,  
48 V DC / 24 V DC, 5 A**

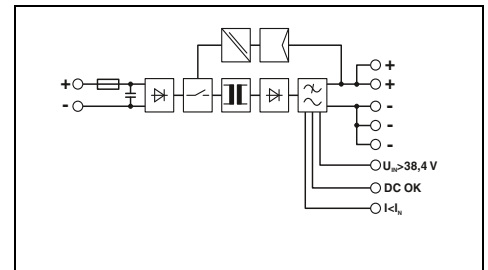

<b>Input data</b>	Nominal input voltage range Current consumption (Power Boost) Inrush current limitation at 25°C / I <sup>2</sup> t Mains buffering (I <sub>N</sub> , typ.)
<b>Output data</b>	Nominal output voltage Setting range of the output voltage (U <sub>Set</sub> )
	Output current / Power Boost / SFB (12 ms) Magnetic circuit breaker tripping Can be connected in parallel/series Max. power dissipation (no load/nominal load) Efficiency
	Residual ripple
<b>Signaling</b>	Signaling DC OK Boost signaling U <sub>N</sub> signaling
<b>General data</b>	Weight / Dimensions W x H x D Assembly instructions
	Connection method Input connection data (solid/stranded/AWG) Output connection data (solid/stranded/AWG) Signal connection data (solid/stranded/AWG) Degree of protection / Protection class MTBF (IEC 61709, SN 29500) Ambient temperature (operation) Max. permissible relative humidity (operation)
<b>Standards/regulations</b>	Insulation voltage input/output Electromagnetic compatibility Electrical safety Electronic equipm. for electrical power installations Safe isolation UL approvals

<b>Technical data</b>	
	48 V DC 3.5 A (48 V DC) < 5 A / < 0.2 A <sup>2</sup> s > 14 ms (48 V DC)
	24 V DC ±1 % 18 V DC ... 29.5 V DC (> 24 V DC, constant capacity restricted)
	5 A / 6.25 A / 30 A B2 / B4 / C2 Yes / yes 2.7 W / 11 W > 91.5 %
	< 25 mV <sub>pp</sub>
	LED, active switching output LED, active switching output LED, active switching output
	0.7 kg / 32 x 130 x 125 mm Alignable: 5 mm horizontally, 15 mm next to active components, 50 mm vertically Plug-in screw connection 0.2 - 2.5 mm <sup>2</sup> / 0.2 - 2.5 mm <sup>2</sup> / 24 - 12 0.2 - 2.5 mm <sup>2</sup> / 0.2 - 2.5 mm <sup>2</sup> / 24 - 12 0.2 - 2.5 mm <sup>2</sup> / 0.2 - 2.5 mm <sup>2</sup> / 24 - 12 IP20 / III > 995000 h (40°C) -25 °C ... 70 °C (> 60 °C derating: 2.5%/K) ≤ 95 % (at 25 °C, non-condensing)
	1 kV (routine test) / 1.5 kV (type test) Conformance with EMC Directive 2014/30/EU EN 60950-1/VDE 0805 (SELV) EN 50178/VDE 0160 (PELV) DIN VDE 0100-410 UL/C-UL listed UL 508, UL/C-UL Recognized UL 60950, UL ANSI/ISA-12.12.01 Class I, Division 2, Groups A, B, C, D (Hazardous Location)

<b>Description</b>	<b>DC/DC converter, primary-switched</b>
--------------------	--

<b>Ordering data</b>		
<b>Type</b>	<b>Order No.</b>	<b>Pcs./Pkt.</b>
QUINT-PS/48DC/24DC/ 5	2320144	1



DC/DC converter,  
48 V DC/48 V DC, 5 A

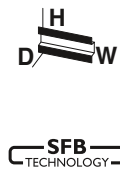

DC/DC converter,  
60 - 72 V DC/24 V DC, 10 A

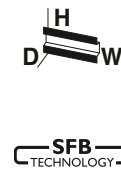

DC/DC converter,  
96 - 110 V DC/24 V DC, 10 A

ERC  
Ex:

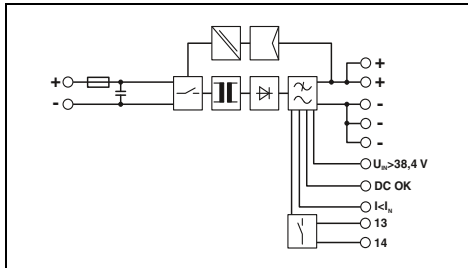

Technical data

48 V DC  
7 A (48 V, I<sub>boost</sub>)  
< 6 A / 0.3 A<sup>2</sup>s  
> 10 ms (48 V DC)

48 V DC ±1 %  
30 V DC ... 56 V DC (> 48 V DC, constant capacity restricted)

5 A / 6.25 A / 30 A  
B2 / B4 / C2  
Yes / yes  
2.7 W / 20 W  
> 93 %

< 20 mV<sub>PP</sub>

LED, active switching output  
LED, active switching output  
LED, active switching output

0.9 kg / 48 x 130 x 125 mm  
Alignable: 5 mm horizontally, 15 mm next to active components, 50 mm vertically  
Plug-in screw connection  
0.2 - 2.5 mm<sup>2</sup> / 0.2 - 2.5 mm<sup>2</sup> / 24 - 12  
0.2 - 2.5 mm<sup>2</sup> / 0.2 - 2.5 mm<sup>2</sup> / 24 - 12  
0.2 - 2.5 mm<sup>2</sup> / 0.2 - 2.5 mm<sup>2</sup> / 24 - 12  
IP20 / III  
> 872000 h (40°C)  
-25 °C ... 70 °C (> 60 °C derating: 2.5%/K)  
≤ 95 % (at 25 °C, non-condensing)

1 kV (routine test) / 1.5 kV (type test)  
Conformance with EMC Directive 2014/30/EU  
EN 60950-1/VDE 0805 (SELV)  
EN 50178/VDE 0160 (PELV)  
DIN VDE 0100-410  
UL/C-UL listed UL 508 , UL/C-UL Recognized UL 60950 ,  
UL ANSI/ISA-12.12.01 Class I, Division 2, Groups A, B, C, D  
(Hazardous Location)

Ordering data

Type	Order No.	Pcs./Pkt.
QUINT-PS/48DC/48DC/5	2905008	1

ERC  
Ex:

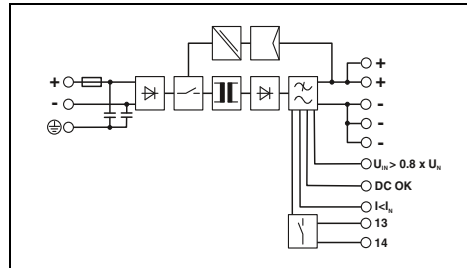

Technical data

60 V DC ... 72 V DC  
5.6 A (60 V DC) / 4.7 A (72 V DC)  
< 9 A / 0.64 A<sup>2</sup>s  
> 10 ms (60 V DC)

24 V DC ±1 %  
18 V DC ... 29.5 V DC (> 24 V DC, constant capacity restricted)

10 A / 12.5 A / 60 A  
B2 / B4 / B6  
Yes / yes  
4 W (U<sub>IN</sub> 60 V DC) / 24 W (U<sub>IN</sub> 60 V DC)  
> 91 % (U<sub>IN</sub> 60 V DC / U<sub>OUT</sub> 24 V DC) /  
> 91 % (U<sub>IN</sub> 72 V DC / U<sub>OUT</sub> 24 V DC)  
< 20 mV<sub>PP</sub>

LED, active switching output, relay contact  
LED, active switching output  
LED, active switching output

1 kg / 48 x 130 x 125 mm  
Alignable: 5 mm horizontally, 15 mm next to active components, 50 mm vertically  
Plug-in screw connection  
0.2 - 2.5 mm<sup>2</sup> / 0.2 - 2.5 mm<sup>2</sup> / 24 - 12  
0.2 - 2.5 mm<sup>2</sup> / 0.2 - 2.5 mm<sup>2</sup> / 24 - 12  
0.2 - 2.5 mm<sup>2</sup> / 0.2 - 2.5 mm<sup>2</sup> / 24 - 12  
IP20 / I  
> 765000 h (40°C)  
-25 °C ... 70 °C (> 60 °C derating: 2.5%/K)  
≤ 95 % (at 25 °C, non-condensing)

1 kV (routine test) / 1.5 kV (type test)  
Conformance with EMC Directive 2014/30/EU  
EN 60950-1/VDE 0805 (SELV)  
EN 50178/VDE 0160 (PELV)  
DIN VDE 0100-410  
UL/C-UL listed UL 508 , UL/C-UL Recognized UL 60950 ,  
UL ANSI/ISA-12.12.01 Class I, Division 2, Groups A, B, C, D  
(Hazardous Location)

Ordering data

Type	Order No.	Pcs./Pkt.
QUINT-PS/60-72DC/24DC/10	2905009	1

ERC  
Ex:

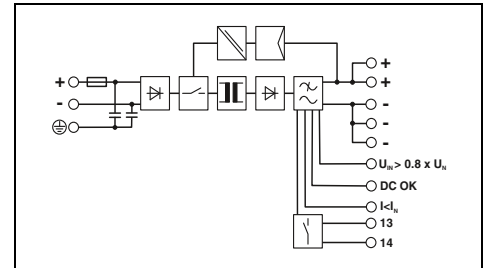

Technical data

96 V DC ... 110 V DC  
3.5 A (96 V DC) / 3.1 A (110 V DC)  
< 10 A / 0.37 A<sup>2</sup>s  
> 10 ms (96 V DC)

24 V DC ±1 %  
18 V DC ... 29.5 V DC (> 24 V DC, constant capacity restricted)

10 A / 12.5 A / 60 A  
B2 / B4 / B6  
Yes / yes  
4 W (U<sub>IN</sub> 110 V DC) / 22 W (U<sub>IN</sub> 110 V DC)  
> 92 % (U<sub>IN</sub> 96 V DC / U<sub>OUT</sub> 24 V DC) /  
> 92 % (U<sub>IN</sub> 110 V DC / U<sub>OUT</sub> 24 V DC)  
< 20 mV<sub>PP</sub>

LED, active switching output, relay contact  
LED, active switching output  
LED, active switching output

0.9 kg / 48 x 130 x 125 mm  
Alignable: 5 mm horizontally, 15 mm next to active components, 50 mm vertically  
Plug-in screw connection  
0.2 - 2.5 mm<sup>2</sup> / 0.2 - 2.5 mm<sup>2</sup> / 24 - 12  
0.2 - 2.5 mm<sup>2</sup> / 0.2 - 2.5 mm<sup>2</sup> / 24 - 12  
0.2 - 2.5 mm<sup>2</sup> / 0.2 - 2.5 mm<sup>2</sup> / 24 - 12  
IP20 / I  
> 772000 h (40°C)  
-25 °C ... 70 °C (> 60 °C derating: 2.5%/K)  
≤ 95 % (at 25 °C, non-condensing)

1 kV (routine test) / 1.5 kV (type test)  
Conformance with EMC Directive 2014/30/EU  
EN 60950-1/VDE 0805 (SELV)  
EN 50178/VDE 0160 (PELV)  
DIN VDE 0100-410  
UL/C-UL listed UL 508 , UL/C-UL Recognized UL 60950 ,  
UL ANSI/ISA-12.12.01 Class I, Division 2, Groups A, B, C, D  
(Hazardous Location)

Ordering data

Type	Order No.	Pcs./Pkt.
QUINT-PS/96-110DC/24DC/10	2905010	1

# Power supplies and UPS

## DC/DC converters

### QUINT DC/DC converters for extreme ambient conditions

#### QUINT POWER with protective coating

With ATEX approval for superior system availability under extreme ambient conditions, such as dust, dirt, corrosive gases, and 100% humidity

- Devices compliant with standards EN 60079-15 and EN 60079-0 may be installed in a potentially explosive area
- Suitable for use in Class I, Division 2
- OVP (overvoltage protection) limits surge voltages to 32 V
- Temperature range from -40°C to +70°C, Groups A, B, C, D



DC/DC converter, with protective coating, 24 V DC/24 V DC, 5 A



DC/DC converter, with protective coating, 24 V DC/24 V DC, 10 A

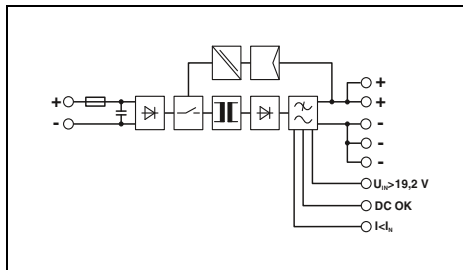

#### Technical data

<b>Input data</b>	
Nominal input voltage range	24 V DC
Current consumption (Power Boost)	7 A (24 V, I <sub>BOOST</sub> )
Inrush current limitation at 25°C / I <sup>2</sup> t	< 15 A / < 0.5 A <sup>2</sup> s
Mains buffering (I <sub>N</sub> , typ.)	> 10 ms (24 V DC)
<b>Output data</b>	
Nominal output voltage	24 V DC ±1 %
Setting range of the output voltage (U <sub>set</sub> )	18 V DC ... 29.5 V DC (> 24 V DC, constant capacity restricted)
Output current / Power Boost / SFB (12 ms)	5 A / 6.25 A / 30 A
Magnetic circuit breaker tripping	B2 / B4 / C2
Can be connected in parallel/series	Yes / yes
Max. power dissipation (no load/nominal load)	2.4 W / 11.4 W
Efficiency	> 92 %
Residual ripple	< 20 mV <sub>pp</sub>
<b>Signaling</b>	
Signaling DC OK	LED, active switching output
Boost signaling	LED, active switching output
U <sub>N</sub> signaling	LED, active switching output
<b>General data</b>	
Weight / Dimensions W x H x D	0.7 kg / 32 x 130 x 125 mm
Assembly instructions	Alignable: 5 mm horizontally, 15 mm next to active components, 50 mm vertically
Connection method	Plug-in screw connection
Input connection data (solid/stranded/AWG)	0.2 - 2.5 mm <sup>2</sup> / 0.2 - 2.5 mm <sup>2</sup> / 24 - 12
Output connection data (solid/stranded/AWG)	0.2 - 2.5 mm <sup>2</sup> / 0.2 - 2.5 mm <sup>2</sup> / 24 - 12
Signal connection data (solid/stranded/AWG)	0.2 - 2.5 mm <sup>2</sup> / 0.2 - 2.5 mm <sup>2</sup> / 24 - 12
Degree of protection / Protection class	IP20 / III
MTBF (IEC 61709, SN 29500)	> 890000 h (40°C)
Ambient temperature (operation)	-25 °C ... 70 °C (> 60 °C derating: 2.5%/K, startup at -40°C type-tested)
Max. permissible relative humidity (operation)	100 % (at 25 °C, non-condensing)
<b>Standards/regulations</b>	
Insulation voltage input/output	1 kV (routine test) / 1.5 kV (type test)
Electromagnetic compatibility	Conformance with EMC Directive 2014/30/EU
Electrical safety	EN 60950-1/VDE 0805 (SELV)
Electronic equipm. for electrical power installations	EN 50178/VDE 0160 (PELV)
Safe isolation	DIN VDE 0100-410
Rail applications	EN 50121-4 / EN 50155
UL approvals	UL/C-UL listed UL 508 , UL/C-UL Recognized UL 60950 , UL ANSI/ISA-12.12.01 Class I, Division 2, Groups A, B, C, D (Hazardous Location)

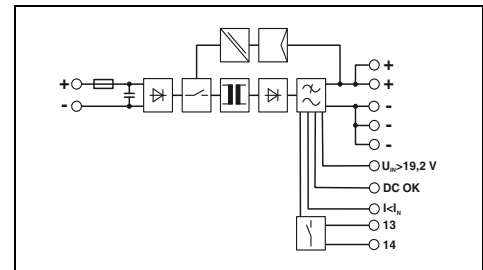

#### Technical data

<b>Input data</b>	
Nominal input voltage range	24 V DC
Current consumption (Power Boost)	14 A (24 V, I <sub>BOOST</sub> )
Inrush current limitation at 25°C / I <sup>2</sup> t	< 15 A / < 2.7 A <sup>2</sup> s
Mains buffering (I <sub>N</sub> , typ.)	> 12 ms (24 V DC)
<b>Output data</b>	
Nominal output voltage	24 V DC ±1 %
Setting range of the output voltage (U <sub>set</sub> )	18 V DC ... 29.5 V DC (> 24 V DC, constant capacity restricted)
Output current / Power Boost / SFB (12 ms)	10 A / 12.5 A / 60 A
Magnetic circuit breaker tripping	B2 / B4 / B6 / C2 / C4
Can be connected in parallel/series	Yes / yes
Max. power dissipation (no load/nominal load)	1.6 W / 24 W
Efficiency	> 92 %
Residual ripple	< 20 mV <sub>pp</sub>
<b>Signaling</b>	
Signaling DC OK	LED, active switching output, relay contact
Boost signaling	LED, active switching output
U <sub>N</sub> signaling	LED, active switching output
<b>General data</b>	
Weight / Dimensions W x H x D	0.9 kg / 48 x 130 x 125 mm
Assembly instructions	Alignable: 5 mm horizontally, 15 mm next to active components, 50 mm vertically
Connection method	Plug-in screw connection
Input connection data (solid/stranded/AWG)	0.2 - 2.5 mm <sup>2</sup> / 0.2 - 2.5 mm <sup>2</sup> / 24 - 12
Output connection data (solid/stranded/AWG)	0.2 - 2.5 mm <sup>2</sup> / 0.2 - 2.5 mm <sup>2</sup> / 24 - 12
Signal connection data (solid/stranded/AWG)	0.2 - 2.5 mm <sup>2</sup> / 0.2 - 2.5 mm <sup>2</sup> / 24 - 12
Degree of protection / Protection class	IP20 / III
MTBF (IEC 61709, SN 29500)	> 763000 h (40°C)
Ambient temperature (operation)	-25 °C ... 70 °C (> 60 °C derating: 2.5%/K, startup at -40°C type-tested)
Max. permissible relative humidity (operation)	100 % (at 25 °C, non-condensing)
<b>Standards/regulations</b>	
Insulation voltage input/output	1 kV (routine test) / 1.5 kV (type test)
Electromagnetic compatibility	Conformance with EMC Directive 2014/30/EU
Electrical safety	EN 60950-1/VDE 0805 (SELV)
Electronic equipm. for electrical power installations	EN 50178/VDE 0160 (PELV)
Safe isolation	DIN VDE 0100-410
Rail applications	EN 50121-4 / EN 50155
UL approvals	UL/C-UL listed UL 508 , UL/C-UL Recognized UL 60950 , UL ANSI/ISA-12.12.01 Class I, Division 2, Groups A, B, C, D (Hazardous Location)

#### Ordering data

Description	Type	Order No.	Pcs./Pkt.
DC/DC converter, primary-switched, dip-coated	QUINT-PS/24DC/24DC/ 5/CO	2320542	1

#### Ordering data

Description	Type	Order No.	Pcs./Pkt.
DC/DC converter, primary-switched, dip-coated	QUINT-PS/24DC/24DC/10/CO	2320555	1



DC/DC converter,  
with protective coating,  
24 V DC/24 V DC, 20 A



DC/DC converter,  
with protective coating,  
60 - 72 V DC/24 V DC, 10 A



DC/DC converter,  
with protective coating,  
96 - 110 V DC/24 V DC, 10 A

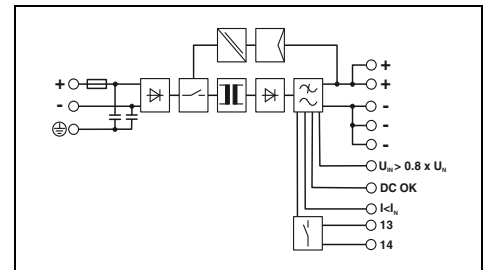
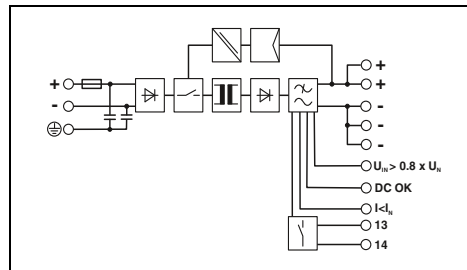
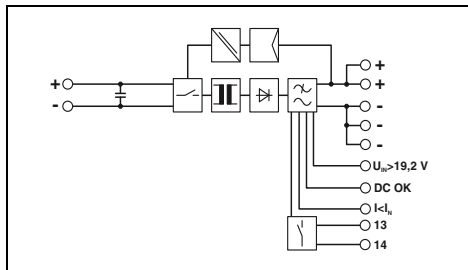

Technical data

24 V DC  
28 A (24 V, I<sub>BOOST</sub>)  
< 26 A / < 11 A<sup>2</sup>s  
> 10 ms (24 V DC)

24 V DC ±1 %  
18 V DC ... 29.5 V DC (> 24 V DC, constant capacity restricted)

20 A / 25 A / 120 A  
B2 / B4 / B6 / B10 / B16 / C2 / C4 / C6  
Yes / yes  
2.2 W / 39 W  
> 92 %

< 20 mV<sub>PP</sub>

LED, active switching output, relay contact  
LED, active switching output  
LED, active switching output

1.7 kg / 82 x 130 x 125 mm  
Alignable: 5 mm horizontally, 15 mm next to active components, 50 mm vertically  
Screw connection  
0.5 - 16 mm<sup>2</sup> / 0.5 - 16 mm<sup>2</sup> / 8 - 6  
0.2 - 6 mm<sup>2</sup> / 0.2 - 4 mm<sup>2</sup> / 12 - 10  
0.2 - 2.5 mm<sup>2</sup> / 0.2 - 2.5 mm<sup>2</sup> / 24 - 12  
IP20 / III  
> 554000 h (40°C)  
-25 °C ... 70 °C (> 60 °C derating: 2.5%/K, startup at -40°C type-tested)  
100 % (at 25 °C, non-condensing)

1 kV (routine test) / 1.5 kV (type test)  
Conformance with EMC Directive 2014/30/EU  
EN 60950-1/VDE 0805 (SELV)  
EN 50178/VDE 0160 (PELV)  
DIN VDE 0100-410  
EN 50121-4 / EN 50155  
UL/C-UL listed UL 508 , UL/C-UL Recognized UL 60950 ,  
UL ANSI/ISA-12.12.01 Class I, Division 2, Groups A, B, C, D  
(Hazardous Location)

Ordering data

Type	Order No.	Pcs./Pkt.
QUINT-PS/24DC/24DC/20/CO	2320568	1

Technical data

60 V DC ... 72 V DC  
5.6 A (60 V DC) / 4.7 A (72 V DC)  
< 9 A / 0.64 A<sup>2</sup>s  
> 10 ms (60 V DC)

24 V DC ±1 %  
18 V DC ... 29.5 V DC (> 24 V DC, constant capacity restricted)

10 A / 12.5 A / 60 A  
B2 / B4 / B6  
Yes / yes  
4 W (U<sub>IN</sub> 60 V DC) / 24 W (U<sub>IN</sub> 60 V DC)  
> 91 % (U<sub>IN</sub> 60 V DC / U<sub>OUT</sub> 24 V DC) /  
> 91 % (U<sub>IN</sub> 72 V DC / U<sub>OUT</sub> 24 V DC)  
< 20 mV<sub>PP</sub>

LED, active switching output, relay contact  
LED, active switching output  
LED, active switching output

1 kg / 48 x 130 x 125 mm  
Alignable: 5 mm horizontally, 15 mm next to active components, 50 mm vertically  
Plug-in screw connection  
0.2 - 2.5 mm<sup>2</sup> / 0.2 - 2.5 mm<sup>2</sup> / 24 - 12  
0.2 - 2.5 mm<sup>2</sup> / 0.2 - 2.5 mm<sup>2</sup> / 24 - 12  
0.2 - 2.5 mm<sup>2</sup> / 0.2 - 2.5 mm<sup>2</sup> / 24 - 12  
IP20 / I  
> 765000 h (40°C)  
-25 °C ... 70 °C (> 60 °C derating: 2.5%/K)  
100 % (at 25 °C, non-condensing)

1 kV (routine test) / 1.5 kV (type test)  
Conformance with EMC Directive 2014/30/EU  
EN 60950-1/VDE 0805 (SELV)  
EN 50178/VDE 0160 (PELV)  
DIN VDE 0100-410  
EN 50121-4 / EN 50155  
UL/C-UL listed UL 508 , UL/C-UL Recognized UL 60950 ,  
UL ANSI/ISA-12.12.01 Class I, Division 2, Groups A, B, C, D  
(Hazardous Location)

Ordering data

Type	Order No.	Pcs./Pkt.
QUINT-PS/60-72DC/24DC/10/CO	2905011	1

Technical data

96 V DC ... 110 V DC  
3.5 A (96 V DC) / 3.1 A (110 V DC)  
< 10 A / 0.37 A<sup>2</sup>s  
> 10 ms (96 V DC)

24 V DC ±1 %  
18 V DC ... 29.5 V DC (> 24 V DC, constant capacity restricted)

10 A / 12.5 A / 60 A  
B2 / B4 / B6  
Yes / yes  
4 W (U<sub>IN</sub> 110 V DC) / 22 W (U<sub>IN</sub> 110 V DC)  
> 92 % (U<sub>IN</sub> 96 V DC / U<sub>OUT</sub> 24 V DC) /  
> 92 % (U<sub>IN</sub> 110 V DC / U<sub>OUT</sub> 24 V DC)  
< 20 mV<sub>PP</sub>

LED, active switching output, relay contact  
LED, active switching output  
LED, active switching output

0.9 kg / 48 x 130 x 125 mm  
Alignable: 5 mm horizontally, 15 mm next to active components, 50 mm vertically  
Plug-in screw connection  
0.2 - 2.5 mm<sup>2</sup> / 0.2 - 2.5 mm<sup>2</sup> / 24 - 12  
0.2 - 2.5 mm<sup>2</sup> / 0.2 - 2.5 mm<sup>2</sup> / 24 - 12  
0.2 - 2.5 mm<sup>2</sup> / 0.2 - 2.5 mm<sup>2</sup> / 24 - 12  
IP20 / I  
> 772000 h (40°C)  
-25 °C ... 70 °C (> 60 °C derating: 2.5%/K)  
100 % (at 25 °C, non-condensing)

1 kV (routine test) / 1.5 kV (type test)  
Conformance with EMC Directive 2014/30/EU  
EN 60950-1/VDE 0805 (SELV)  
EN 50178/VDE 0160 (PELV)  
DIN VDE 0100-410  
EN 50121-4 / EN 50155  
UL/C-UL listed UL 508 , UL/C-UL Recognized UL 60950 ,  
UL ANSI/ISA-12.12.01 Class I, Division 2, Groups A, B, C, D  
(Hazardous Location)

Ordering data

Type	Order No.	Pcs./Pkt.
QUINT-PS/96-110DC/24DC/10/CO	2905012	1

# Power supplies and UPS

## DC/DC converters

### MINI DC/DC converters

#### MINI POWER, 12 V DC to 60 V DC input

- Support conversion to various voltage levels
- Constant voltage: output voltage regenerated even at the end of long cables
- Electrical isolation: for setting up independent supply systems

#### MINI AC power module

- For connection upstream of MINI DC/DC converters
- The AC voltage of a transformer is rectified and filtered

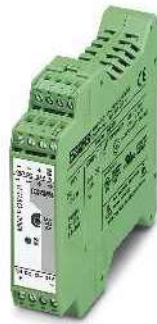

DC/DC converter,  
12 - 24 V DC / 24 V DC, 1 A



DC/DC converter,  
12 - 24 V DC / 5 - 15 V DC, 2 A

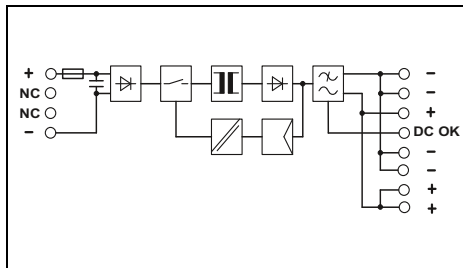

#### Technical data

Input data	
Nominal input voltage range	12 V DC ... 24 V DC
Current consumption (nominal load)	2.6 A (12 V DC) / 1.3 A (24 V DC)
Inrush current limitation at 25°C / I <sup>2</sup> t	< 15 A / 1.8 A <sup>2</sup> s
Output data	
Nominal output voltage	24 V DC ±1 %
Setting range of the output voltage (U <sub>set</sub> )	22.5 V DC ... 28.5 V DC (> 24 V DC, constant capacity restricted)
Output current	1 A
Can be connected in parallel/series	Yes / yes
Max. power dissipation (no load/nominal load)	< 1.2 W / < 5 W
Efficiency	> 83 % (at 24 V DC and nominal values)
Residual ripple	< 30 mV <sub>pp</sub>
Signaling	
Signaling DC OK	LED, active switching output
General data	
Weight / Dimensions W x H x D	0.2 kg / 22.5 x 99 x 107 mm
Assembly instructions	Can be aligned: Horizontally 0 mm, vertically 50 mm
Connection method	Plug-in screw connection
Input connection data (solid/stranded/AWG)	0.2 - 2.5 mm <sup>2</sup> / 0.2 - 2.5 mm <sup>2</sup> / 24 - 14
Output connection data (solid/stranded/AWG)	0.2 - 2.5 mm <sup>2</sup> / 0.2 - 2.5 mm <sup>2</sup> / 24 - 14
Signal connection data (solid/stranded/AWG)	0.2 - 2.5 mm <sup>2</sup> / 0.2 - 2.5 mm <sup>2</sup> / 24 - 14
Degree of protection / Protection class	IP20 / III
MTBF (IEC 61709, SN 29500)	> 2569000 h (40°C)
Ambient temperature (operation)	-25 °C ... 70 °C (> 60 °C derating: 2.5%/K)
Max. permissible relative humidity (operation)	≤ 95 % (at 25 °C, non-condensing)
Standards/regulations	
Insulation voltage input/output	1 kV (routine test) / 1.5 kV (type test)
Electromagnetic compatibility	Conformance with EMC Directive 2014/30/EU
Electrical safety	EN 60950-1/VDE 0805 (SELV)
Electronic equipm. for electrical power installations	EN 50178/VDE 0160 (PELV)
Safe isolation	DIN VDE 0100-410, DIN VDE 0106-101
UL approvals	UL/C-UL listed UL 508, UL/C-UL Recognized UL 60950, UL ANSI/ISA-12.12.01 Class I, Division 2, Groups A, B, C, D (Hazardous Location)

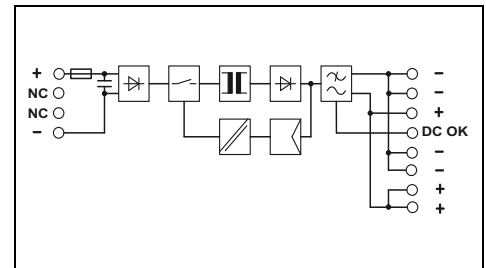

#### Technical data

Input data	
Nominal input voltage range	12 V DC ... 24 V DC
Current consumption (nominal load)	2.3 A (12 V DC) / 1.1 A (24 V DC)
Inrush current limitation at 25°C / I <sup>2</sup> t	< 10 A / 0.2 A <sup>2</sup> s
Output data	
Nominal output voltage	12 V DC ±1 %
Setting range of the output voltage (U <sub>set</sub> )	5 V DC ... 15 V DC
Output current	2 A
Can be connected in parallel/series	Yes / yes
Max. power dissipation (no load/nominal load)	< 1 W / < 4.2 W
Efficiency	> 88 % (at 24 V DC and nominal values)
Residual ripple	< 20 mV <sub>pp</sub>
Signaling	
Signaling DC OK	LED, active switching output
General data	
Weight / Dimensions W x H x D	0.2 kg / 22.5 x 99 x 107 mm
Assembly instructions	Can be aligned: Horizontally 0 mm, vertically 50 mm
Connection method	Plug-in screw connection
Input connection data (solid/stranded/AWG)	0.2 - 2.5 mm <sup>2</sup> / 0.2 - 2.5 mm <sup>2</sup> / 24 - 14
Output connection data (solid/stranded/AWG)	0.2 - 2.5 mm <sup>2</sup> / 0.2 - 2.5 mm <sup>2</sup> / 24 - 14
Signal connection data (solid/stranded/AWG)	0.2 - 2.5 mm <sup>2</sup> / 0.2 - 2.5 mm <sup>2</sup> / 24 - 14
Degree of protection / Protection class	IP20 / III
MTBF (IEC 61709, SN 29500)	> 2072000 h (40°C)
Ambient temperature (operation)	-25 °C ... 70 °C (> +60 °C derating)
Max. permissible relative humidity (operation)	≤ 95 % (At +25°C, non-condensing)
Standards/regulations	
Insulation voltage input/output	1 kV (routine test) / 1.5 kV (type test)
Electromagnetic compatibility	Conformance with EMC Directive 2014/30/EU
Electrical safety	EN 60950-1/VDE 0805 (SELV)
Electronic equipm. for electrical power installations	EN 50178/VDE 0160 (PELV)
Safe isolation	DIN VDE 0100-410, DIN VDE 0106-101
UL approvals	UL/C-UL listed UL 508, UL/C-UL Recognized UL 60950, UL ANSI/ISA-12.12.01 Class I, Division 2, Groups A, B, C, D (Hazardous Location)

#### Ordering data

Description	Type	Order No.	Pcs./Pkt.
DC/DC converter, primary-switched	MINI-PS- 12- 24DC/24DC/1	2866284	1

#### Ordering data

Description	Type	Order No.	Pcs./Pkt.
DC/DC converter, primary-switched	MINI-PS- 12- 24DC/ 5-15DC/2	2320018	1



DC/DC converter,  
12 - 24 V DC / 48 V DC, 0.7 A

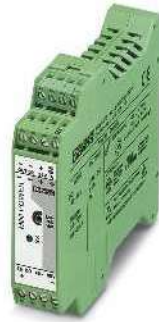

DC/DC converter,  
48 - 60 V DC / 24 V DC, 1 A



AC power module for  
MINI DC/DC converter

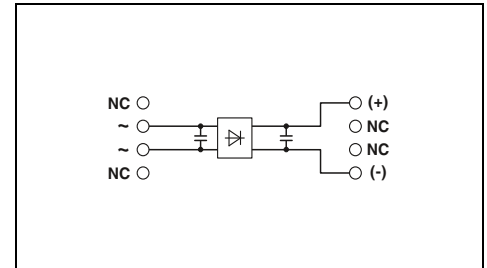
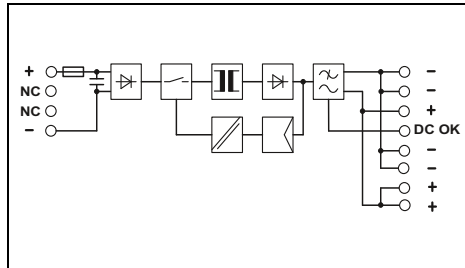
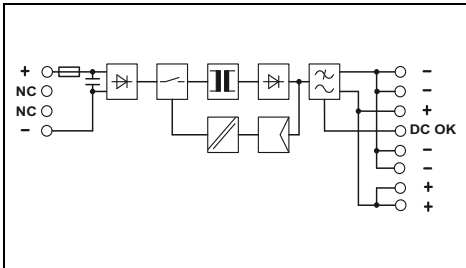

Technical data

12 V DC ... 24 V DC  
3.2 A (12 V DC) / 1.6 A (24 V DC)  
< 10 A / 0.3 A<sup>2</sup>s

48 V DC ±1 %  
30 V DC ... 56 V DC (> 48 V DC, constant capacity restricted)

0.7 A  
Yes / yes  
< 1.5 W / < 4.5 W  
> 87 % (at 24 V DC and nominal values)  
< 20 mV<sub>pp</sub>

LED, active switching output

0.2 kg / 22.5 x 99 x 107 mm  
Can be aligned: Horizontally 0 mm, vertically 50 mm  
Plug-in screw connection  
0.2 - 2.5 mm<sup>2</sup> / 0.2 - 2.5 mm<sup>2</sup> / 24 - 14  
0.2 - 2.5 mm<sup>2</sup> / 0.2 - 2.5 mm<sup>2</sup> / 24 - 14  
0.2 - 2.5 mm<sup>2</sup> / 0.2 - 2.5 mm<sup>2</sup> / 24 - 14  
IP20 / III  
> 1993000 h (40°C)  
-25 °C ... 70 °C (> +60°C derating)  
≤ 95 % (At +25°C, non-condensing)

1 kV (routine test) / 1.5 kV (type test)  
Conformance with EMC Directive 2014/30/EU  
EN 60950-1/VDE 0805 (SELV)  
EN 50178/VDE 0160 (PELV)  
DIN VDE 0100-410, DIN VDE 0106-101  
UL/C-UL listed UL 508, UL/C-UL Recognized UL 60950,  
UL ANSI/ISA-12.12.01 Class I, Division 2, Groups A, B, C, D  
(Hazardous Location)

Ordering data

Type	Order No.	Pcs./Pkt.
MINI-PS-12-24DC/48DC/0.7	2320021	1

Technical data

48 V DC ... 60 V DC  
0.6 A (48 V DC) / 0.5 A (60 V DC)  
< 15 A / 1.8 A<sup>2</sup>s

24 V DC ±1 %  
22.5 V DC ... 28.5 V DC (> 24 V DC, constant capacity restricted)

1 A  
Yes / yes  
< 1.2 W / < 4.5 W  
> 85 % (at 60 V DC and nominal values)  
< 40 mV<sub>pp</sub>

LED, active switching output

0.2 kg / 22.5 x 99 x 107 mm  
Can be aligned: Horizontally 0 mm, vertically 50 mm  
Plug-in screw connection  
0.2 - 2.5 mm<sup>2</sup> / 0.2 - 2.5 mm<sup>2</sup> / 24 - 14  
0.2 - 2.5 mm<sup>2</sup> / 0.2 - 2.5 mm<sup>2</sup> / 24 - 14  
0.2 - 2.5 mm<sup>2</sup> / 0.2 - 2.5 mm<sup>2</sup> / 24 - 14  
IP20 / III  
> 1147000 h (40°C)  
-25 °C ... 70 °C (> 60 °C derating: 2.5%/K)  
≤ 95 % (at 25 °C, non-condensing)

1 kV (routine test) / 1.5 kV (type test)  
Conformance with EMC Directive 2014/30/EU  
EN 60950-1/VDE 0805 (SELV)  
EN 50178/VDE 0160 (PELV)  
DIN VDE 0100-410, DIN VDE 0106-101  
UL/C-UL listed UL 508, UL/C-UL Recognized UL 60950,  
UL ANSI/ISA-12.12.01 Class I, Division 2, Groups A, B, C, D  
(Hazardous Location)

Ordering data

Type	Order No.	Pcs./Pkt.
MINI-PS-48-60DC/24DC/1	2866271	1

Technical data

10 V AC ... 42 V AC  
6.5 A  
< 45 A / 8 A<sup>2</sup>s

28 V DC ±1 %  
-

3 A  
Yes / No  
< 0.04 W / < 6.9 W  
> 95.7 % (For 42 V AC and nominal values)  
< 3.6 V<sub>pp</sub>

-

0.16 kg / 22.5 x 99 x 107 mm  
Can be aligned: Horizontally 0 mm, vertically 50 mm  
Plug-in screw connection  
0.2 - 2.5 mm<sup>2</sup> / 0.2 - 2.5 mm<sup>2</sup> / 24 - 12  
0.2 - 2.5 mm<sup>2</sup> / 0.2 - 2.5 mm<sup>2</sup> / 24 - 12  
- / - / -  
IP20 / III  
> 18175000 h (40°C)  
-25 °C ... 70 °C (> 60 °C derating: 2.5%/K)  
≤ 95 % (at 25 °C, non-condensing)

1 kV (routine test) / 1.5 kV (type test)  
Conformance with EMC Directive 2014/30/EU  
EN 60950-1/VDE 0805 (SELV)  
EN 50178/VDE 0160 (PELV)  
-  
UL/C-UL listed UL 508, UL/C-UL Recognized UL 60950

Ordering data

Type	Order No.	Pcs./Pkt.
MINI-PS-10-42AC/15-60DC/3	2320199	1



### Maximum availability due to redundancy modules

To prevent errors influencing the load in a redundant system and to increase operational reliability, the power supplies must be decoupled from one another using a redundancy module. Phoenix Contact offers various solutions depending on the requirements:

#### Decoupling with diodes from the QUINT, TRIO, UNO, and STEP ranges

If the power supplies are decoupled, a short circuit at the output of one of the power supply units or in the supply line from the power supply unit to the diode no longer has any effect on the load.

#### Decoupling, monitoring, and closed-loop control by means of the QUINT ORING active redundancy modules

The QUINT ORING active redundancy modules monitor the entire redundant solution, i.e., the power supply unit voltages, the wiring, decoupling, and the load current. Critical operating states can therefore be detected at an early stage and redundancy can be restored. E.g., incorrect wiring or faulty cables are indicated.

QUINT ORING with ACB Technology doubles the service life of the redundant system:

As a result of asymmetries, the load is often supplied by one power supply unit, while the other runs in no-load operation. This results in a thermal overload of the working power supply unit and therefore rapid aging. If the power supply unit is operated at half the nominal current, it remains significantly cooler. The ACB Technology of the QUINT ORING modules ensures symmetrical loading of the power supplies and thereby up to double the service life of the redundant system.

#### Decoupling and monitoring by means of the QUINT S-ORING active redundancy modules

The QUINT S-ORING active redundancy modules consistently monitor the redundant system, in combination with the new QUINT POWER power supplies. With QUINT S-ORING, the cable is routed redundantly and separately up to the load.

QUINT S-ORING with protective coating with OVP (overvoltage protection) protects downstream loads from surge voltages greater than 30 V DC.

**i** Your web code: **#0153**



**ACB Technology doubles the service life**

The ACB (Auto Current Balancing) Technology ensures symmetrical loading of the power supplies, thereby reducing the operating temperature. This means up to double the service life of the redundant system.



**QUINT ORING for maximum system availability**

Consistent monitoring of the redundant system, with energy savings of up to 70%.

**QUINT ORING**

- ACB Technology
- Two positive output terminals
- Voltage limitation to < 32 V DC (+Version)

**QUINT S-ORING**

- Separate cable routing up to the load
- Voltage limitation to < 30 V DC (+Version)



**QUINT DIODE redundancy module**

- High system availability, thanks to the robust design
- Safe decoupling of power supplies connected in parallel
- Flexible: nominal voltages of 12 V DC to 48 V DC



**TRIO DIODE redundancy module**

- Safe decoupling of power supplies connected in parallel
- Quick and easy installation, thanks to Push-in connection technology
- System compatible with TRIO POWER power supplies



**UNO DIODE redundancy module**

- Consistent redundancy up to the load
- Flexible: nominal voltages of 5 V DC to 24 V DC



**STEP DIODE redundancy module**

- Space-saving: overall width of just 18 mm
- Consistent redundancy up to the load
- Flexible: nominal voltages of 5 V DC to 24 V DC

### QUINT ORING

#### QUINT ORING, 24 V DC

- Preventive function monitoring
- Consistent redundancy up to the load: the use of two positive output terminals makes it possible to design a redundant wiring concept up to the load
- Double the service life of the redundant solution thanks to even load distribution: the ACB (Auto Current Balancing) Technology automatically and symmetrically distributes the load current to two power supplies operating in parallel.
- Save energy: decoupling is achieved with MOSFETs and results in energy savings of up to 70% compared with conventional diodes.
- OVP (overvoltage protection): surge voltages are limited to 32 V

#### QUINT ORING, with protective coating

With ATEX approval for superior system availability under extreme ambient conditions, such as dust, dirt, corrosive gases, and 100% humidity

- Devices compliant with standards EN 60079-15 and EN 60079-0 may be installed in a potentially explosive area
- Suitable for use in Class I, Division 2



**Active redundancy module, with protective coating, 24 V DC, 2 x 10 A, 1 x 20 A**

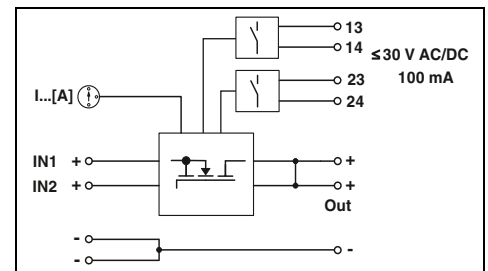

#### Technical data

<b>Input data</b>	24 V DC 18 V DC ... 28 V DC 2x 10 A (-25 °C ... 60 °C) 1x 20 A (-25 °C ... 60 °C) 2x 15 A (-25 °C ... 40 °C) 1x 30 A (-25 °C ... 40 °C)
Nominal input voltage range	24 V DC
Input voltage range	18 V DC ... 28 V DC
Nominal current	2x 10 A (-25 °C ... 60 °C) 1x 20 A (-25 °C ... 60 °C) 2x 15 A (-25 °C ... 40 °C) 1x 30 A (-25 °C ... 40 °C)
<b>Maximum current</b>	Varistor 0.1 V (I <sub>OUT</sub> = 20 A) 2 W (I <sub>OUT</sub> = 20 A)
Transient surge protection	0.4 kg / 32 x 130 x 125 mm
Voltage drop, input/output	Alignable: 5 mm horizontally, 15 mm next to active components, 50 mm vertically
Max. power dissipation (nominal load)	Screw connection 0.2 - 4 mm <sup>2</sup> / 0.2 - 2.5 mm <sup>2</sup> / 14 - 12 0.2 - 6 mm <sup>2</sup> / 0.2 - 4 mm <sup>2</sup> / 10
<b>General data</b>	IP20 / III -25 °C ... 70 °C (> 60 °C derating: 2.5%/K)
Weight / Dimensions W x H x D	500 V
Assembly instructions	Conformance with EMC Directive 2014/30/EU EN 60950-1/VDE 0805 (SELV) EN 50178/VDE 0160 (PELV) UL/C-UL listed UL 508 , UL/C-UL Recognized UL 60950 , UL ANSI/ISA-12.12.01 Class I, Division 2, Groups A, B, C, D (Hazardous Location)
Connection method	
Input connection data (solid/stranded/AWG)	
Output connection data (solid/stranded/AWG)	
Degree of protection / Protection class	
Ambient temperature (operation)	
<b>Standards/regulations</b>	
Insulation voltage: input, output/housing	
Electromagnetic compatibility	
Electrical safety	
Electronic equipm. for electrical power installations	
UL approvals	

#### Ordering data

Description	Type	Order No.	Pcs./Pkt.
<b>Active redundancy module</b>	QUINT-ORING/24DC/2X10/1X20	2320173	1

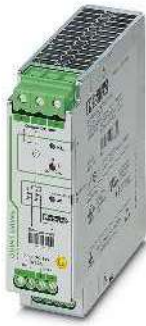

Active redundancy module,  
with protective coating,  
24 V DC, 2 x 20 A, 1 x 40 A



Active redundancy module  
24 V DC, 2 x 40 A, 1 x 80 A

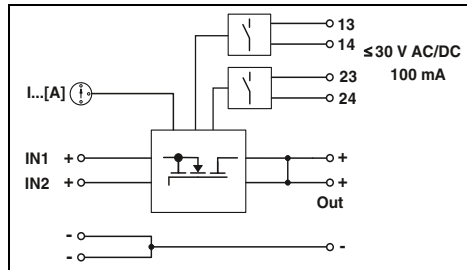
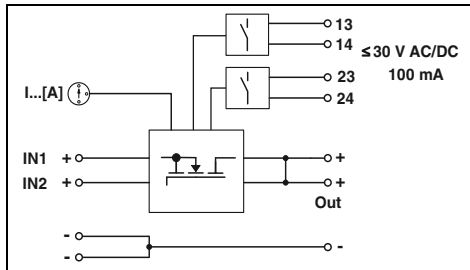

Technical data

24 V DC  
18 V DC ... 28 V DC  
2x 20 A (-25 °C ... 60 °C)  
1x 40 A (-25 °C ... 60 °C)  
2x 26 A (-25 °C ... 40 °C)  
1x 52 A (-25 °C ... 40 °C)  
Varistor  
0.2 V (I<sub>OUT</sub> = 40 A)  
8 W (I<sub>OUT</sub> = 40 A)

0.6 kg / 38 x 130 x 125 mm  
Alignable: 5 mm horizontally, 15 mm next to active components,  
50 mm vertically  
Screw connection  
0.2 - 6 mm<sup>2</sup> / 0.2 - 4 mm<sup>2</sup> / 10  
0.5 - 16 mm<sup>2</sup> / 0.5 - 16 mm<sup>2</sup> / 6  
IP20 / III  
-25 °C ... 70 °C (> 60 °C derating: 2.5%/K)

500 V  
Conformance with EMC Directive 2014/30/EU  
EN 60950-1/VDE 0805 (SELV)  
EN 50178/VDE 0160 (PELV)  
UL/C-UL listed UL 508 , UL/C-UL Recognized UL 60950 ,  
UL ANSI/ISA-12.12.01 Class I, Division 2, Groups A, B, C, D  
(Hazardous Location)

Technical data

24 V DC  
18 V DC ... 28 V DC  
2x 40 A (-25 °C ... 60 °C)  
1x 80 A (-25 °C ... 60 °C)  
2x 45 A (-25 °C ... 40 °C)  
1x 90 A (-25 °C ... 40 °C)  
Varistor  
0.2 V (I<sub>OUT</sub> = 80 A)  
16 W (I<sub>OUT</sub> = 80 A)

0.9 kg / 66 x 130 x 125 mm  
Alignable: 5 mm horizontally, 15 mm next to active components,  
50 mm vertically  
Screw connection  
0.5 - 16 mm<sup>2</sup> / 0.5 - 16 mm<sup>2</sup> / 6  
0.5 - 35 mm<sup>2</sup> / 0.5 - 35 mm<sup>2</sup> / 2  
IP20 / III  
-25 °C ... 70 °C (> 60 °C derating: 2.5%/K)

500 V  
Conformance with EMC Directive 2014/30/EU  
EN 60950-1/VDE 0805 (SELV)  
EN 50178/VDE 0160 (PELV)  
UL/C-UL listed UL 508 , UL/C-UL Recognized UL 60950 ,  
UL ANSI/ISA-12.12.01 Class I, Division 2, Groups A, B, C, D  
(Hazardous Location)

Ordering data

Type	Order No.	Pcs./Pkt.
QUINT-ORING/24DC/2X20/1X40	2320186	1

Ordering data

Type	Order No.	Pcs./Pkt.
QUINT-ORING/24DC/2X40/1X80	2902879	1

### QUINT ORING

#### QUINT S-ORING, 12 - 24 V DC

- Consistent redundancy: separate cable routing up to the load
- Preventive function monitoring
- Save energy: disconnection is implemented with MOSFETs and therefore has very low power dissipation
- Suitable for use in Class I, Division 2

#### QUINT S-ORING with ATEX approval, protective coating

With protective coating for superior system availability under extreme ambient conditions, such as dust, dirt, corrosive gases, and 100% humidity

- OVP (overvoltage protection): surge voltages are limited to 30 V
- Devices compliant with standards EN 60079-15 and EN 60079-0 may be installed in a potentially explosive area



new

Active redundancy module  
12 - 24 V DC, 1 x 40 A

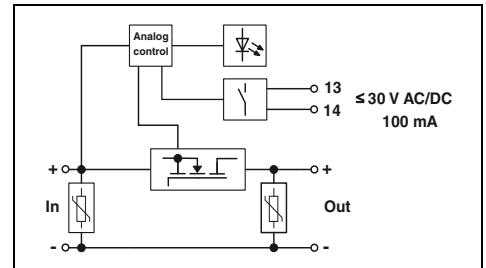

#### Technical data

##### Input data

Nominal input voltage range  
Input voltage range  
Nominal current  
Input current  $I_{Stat.Boost} / I_{Dyn.Boost} / I_{SFB}$

Transient surge protection  
Voltage drop, input/output  
Max. power dissipation (nominal load)

##### General data

Weight / Dimensions W x H x D  
Assembly instructions

Connection method  
Input connection data (solid/stranded/AWG)  
Output connection data (solid/stranded/AWG)  
Degree of protection / Protection class  
Ambient temperature (operation)

##### Standards/regulations

Insulation voltage: input, output/housing  
Electromagnetic compatibility  
Electrical safety  
Electronic equipm. for electrical power installations  
UL approvals

12 V DC ... 24 V DC  
8 V DC ... 30 V DC  
40 A (-40 °C ... 60 °C)  
45 A (40 °C) / 60 A (5 s) / 215 A (15 ms)

Varistor  
0.1 V  
6 W ( $I_{OUT} = 40$  A)

0.55 kg / 32 x 130 x 125 mm  
Alignable: 5 mm horizontally, 15 mm next to active components, 50 mm vertically  
Screw connection  
0.5 - 16 mm<sup>2</sup> / 0.5 - 16 mm<sup>2</sup> / 20 - 6  
0.5 - 16 mm<sup>2</sup> / 0.5 - 16 mm<sup>2</sup> / 20 - 6  
IP20 / III  
-40 °C ... 70 °C (> 60 °C derating: 2.5%/K)

500 V  
Conformance with EMC Directive 2014/30/EU  
EN 60950-1/VDE 0805 (SELV)  
EN 50178/VDE 0160 (PELV)  
UL/C-UL listed UL 508, UL/C-UL Recognized UL 60950, UL ANSI/ISA-12.12.01 Class I, Division 2, Groups A, B, C, D (Hazardous Location)

#### Ordering data

Description

Active redundancy module

Type	Order No.	Pcs./Pkt.
QUINT4-S-ORING/12-24DC/1X40	2907752	1



new



Active redundancy module,  
with protective coating,  
12 - 24 V DC, 1 x 40 A



Ex:

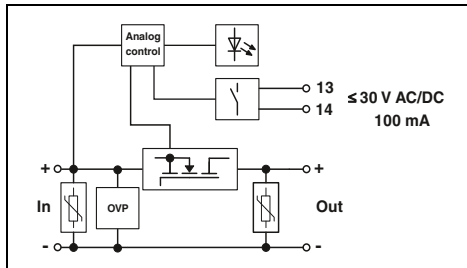

#### Technical data

12 V DC ... 24 V DC  
8 V DC ... 26 V DC  
40 A (-40 °C ... 60 °C)  
45 A (40 °C) / 60 A (5 s) / 215 A (15 ms)

Varistor  
0.1 V  
6.5 W ( $I_{OUT} = 40$  A)

0.4 kg / 32 x 130 x 125 mm  
Alignable: 5 mm horizontally, 15 mm next to active components,  
50 mm vertically  
Screw connection  
0.5 - 16 mm<sup>2</sup> / 0.5 - 16 mm<sup>2</sup> / 20 - 6  
0.5 - 16 mm<sup>2</sup> / 0.5 - 16 mm<sup>2</sup> / 20 - 6  
IP20 / III  
-40 °C ... 70 °C (> 60 °C derating: 2.5%/K)

500 V  
Conformance with EMC Directive 2014/30/EU  
EN 60950-1/VDE 0805 (SELV)  
EN 50178/VDE 0160 (PELV)  
UL/C-UL listed UL 508, UL/C-UL Recognized UL 60950,  
UL ANSI/ISA-12.12.01 Class I, Division 2, Groups A, B, C, D  
(Hazardous Location)

#### Ordering data

Type	Order No.	Pcs./Pkt.
QUINT4-S-ORING/12-24DC/1X40/+	2907753	1

### QUINT DIODE diode module

#### QUINT DIODE, 12 - 24 V DC and 48 V DC

- Robust design for currents of up to 60 A
- Consistent redundancy up to the load: the use of two positive output terminals makes it possible to design a redundant wiring concept up to the load
- Consistent wiring with large conductor cross sections, thanks to same size of input and output terminals
- Flexible: nominal voltages of 12 V DC to 48 V DC
- Devices compliant with standards EN 60079-15 and EN 60079-0 may be installed in a potentially explosive area
- Suitable for use in Class I, Division 2



new

Diode module,  
12 - 24 V DC, 2 x 20 A, 1 x 40 A

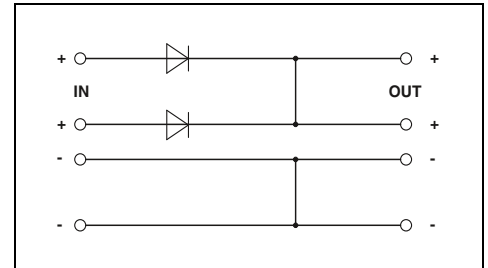

Technical data	
Input data	
Nominal input voltage range	12 V DC ... 24 V DC 12 V DC ... 24 V DC
Input voltage range	10 V DC ... 30 V DC 10 V DC ... 30 V DC
Nominal current	2x 20 A (-25 °C ... 60 °C) 1x 40 A (-25 °C ... 60 °C)
Maximum current	2x 30 A (-25 °C ... 40 °C) 1x 60 A (-25 °C ... 40 °C)
Transient surge protection	Varistor
Voltage drop, input/output	0.5 V
Max. power dissipation (nominal load)	10 W (I <sub>OUT</sub> = 20 A)
General data	
Weight / Dimensions W x H x D	0.75 kg / 50 x 130 x 125 mm
Assembly instructions	Alignable: 5 mm horizontally, 15 mm next to active components, 50 mm vertically
Connection method	Screw connection
Input connection data (solid/stranded/AWG)	0.5 - 16 mm <sup>2</sup> / 0.5 - 16 mm <sup>2</sup> / 10 - 6
Output connection data (solid/stranded/AWG)	0.5 - 16 mm <sup>2</sup> / 0.5 - 16 mm <sup>2</sup> / 10 - 6
Degree of protection / Protection class	IP20 / III
Ambient temperature (operation)	-40 °C ... 70 °C (> 60 °C derating: 2.5%/K)
Standards/regulations	
Insulation voltage: input, output/housing	500 V
Electromagnetic compatibility	Conformance with EMC Directive 2014/30/EU
Electrical safety, safety transformer	EN 60950-1/VDE 0805 (SELV)
Electronic equipm. for electrical power installations	EN 50178/VDE 0160 (PELV)
UL approvals	UL/C-UL listed UL 508, UL/C-UL Recognized UL 60950, UL ANSI/ISA-12.12.01 Class I, Division 2, Groups A, B, C, D (Hazardous Location)

Ordering data		
Type	Order No.	Pcs./Pkt.
QUINT4-DIODE/12-24DC/2X20/1X40	2907719	1

Description
Diode module

new



**Diode module,  
48 V DC, 2x 20 A, 1x 40 A**

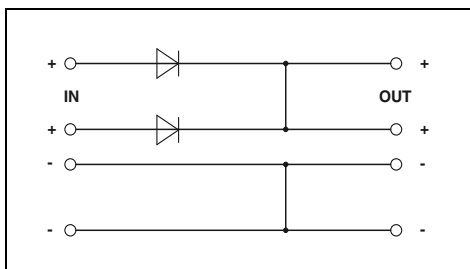

**Technical data**

48 V DC  
 48 V DC  
 30 V DC ... 56 V DC  
 30 V DC ... 56 V DC  
 2x 20 A (-25 °C ... 60 °C)  
 1x 40 A (-25 °C ... 60 °C)  
 2x 30 A (-25 °C ... 40 °C)  
 1x 60 A (-25 °C ... 40 °C)  
 Varistor  
 0.7 V  
 14 W (I<sub>OUT</sub> = 20 A)

0.75 kg / 50 x 130 x 125 mm  
 Alignable: 5 mm horizontally, 15 mm next to active components,  
 50 mm vertically  
 Screw connection  
 0.5 - 16 mm<sup>2</sup> / 0.5 - 16 mm<sup>2</sup> / 10 - 6  
 0.5 - 16 mm<sup>2</sup> / 0.5 - 16 mm<sup>2</sup> / 10 - 6  
 IP20 / III  
 -40 °C ... 70 °C (> 60 °C derating: 2.5%/K)

500 V  
 Conformance with EMC Directive 2014/30/EU  
 EN 60950-1/VDE 0805 (SELV)  
 EN 50178/VDE 0160 (PELV)  
 UL/C-UL listed UL 508 , UL/C-UL Recognized UL 60950 ,  
 UL ANSI/ISA-12.12.01 Class I, Division 2, Groups A, B, C, D  
 (Hazardous Location)

**Ordering data**

Type	Order No.	Pcs./Pkt.
QUINT4-DIODE/48DC/2X20/1X40	2907720	1

## Redundancy modules

### TRIO DIODE, UNO DIODE, and STEP DIODE diode modules

#### TRIO DIODE

- Space-saving: overall width of just 35 mm and 41 mm
- Safe decoupling of power supplies connected in parallel
- Quick and easy installation, thanks to Push-in connection technology
- System compatible with TRIO POWER power supplies

#### UNO DIODE

- Space-saving: overall width of just 22.5 mm
- Consistent redundancy up to the load: the use of two positive output terminals makes it possible to design a redundant wiring concept up to the load
- Flexible: nominal voltages of 5 V DC to 24 V DC

#### STEP DIODE

- Space-saving: overall width of just 18 mm
- Consistent redundancy up to the load: the use of two positive output terminals makes it possible to design a redundant wiring concept up to the load
- Flexible: nominal voltages of 5 V DC to 24 V DC



new

Diode module,  
12 ... 24 V DC, 2 x 10 A, 1 x 20 A

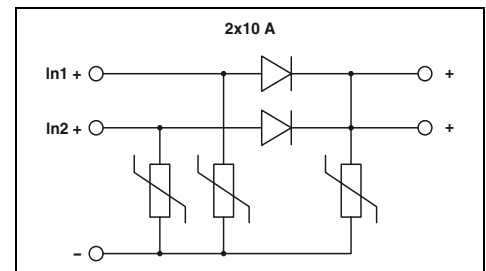

#### Technical data

Input data	
Nominal input voltage range	12 V DC ... 24 V DC
Input voltage range	10 V DC ... 30 V DC
Nominal current	2x 10 A (-25 °C ... 60 °C) 1x 20 A (-25 °C ... 60 °C)
Maximum current	2x 15 A (-25 °C ... 40 °C) 1x 30 A (-25 °C ... 40 °C)
Transient surge protection	Varistor
Voltage drop, input/output	0,5 V
Max. power dissipation (nominal load)	5 W (I <sub>OUT</sub> = 10 A)
General data	
Weight / Dimensions W x H x D	0,4 kg / 35 x 130 x 115 mm
Assembly instructions	Alignable: 0 mm horizontally, 30 mm vertically
Connection method	Push-in connection
Input connection data (solid/stranded/AWG)	0,2 - 4 mm <sup>2</sup> / 0,2 - 2,5 mm <sup>2</sup> / 24 - 12
Output connection data (solid/stranded/AWG)	0,2 - 2,5 mm <sup>2</sup> / 0,2 - 2,5 mm <sup>2</sup> / 24 - 14
Degree of protection / Protection class	IP20 / III
Ambient temperature (operation)	-25 °C ... 70 °C (> 60 °C derating: 2.5%/K)
Standards/regulations	
Insulation voltage: input, output/housing	500 V
Electromagnetic compatibility	Conformance with EMC Directive 2014/30/EU
Electrical safety, safety transformer	IEC 60950-1/VDE 0805 (SELV)
Electronic equipm. for electrical power installations	EN 50178/VDE 0160 (PELV)
UL approvals	UL/C-UL listed UL 508 , UL/C-UL Recognized UL 60950

#### Ordering data

Description	Type	Order No.	Pcs./Pkt.
Redundancy module	TRIO2-DIODE/12-24DC/2X10/1X20	2907380	1

new



**Diode module,**  
12 ... 24 V DC, 2 x 20 A, 1 x 40 A



**Diode module,**  
5 ... 24 V DC, 2 x 10 A, 1 x 20 A



**Diode module**  
5 - 24 V DC, 2x 5 A, 1x 10 A

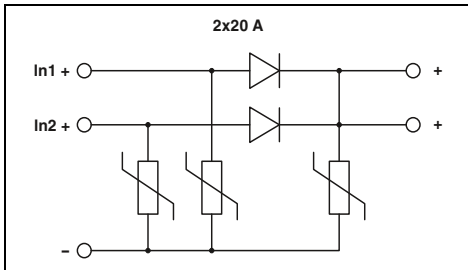

**Technical data**

12 V DC ... 24 V DC  
10 V DC ... 30 V DC  
2x 20 A (-25 °C ... 60 °C)  
1x 40 A (-25 °C ... 60 °C)  
2x 25 A (-25 °C ... 40 °C)  
1x 50 A (-25 °C ... 40 °C)  
Varistor  
0.5 V  
10 W (I<sub>OUT</sub> = 20 A)

0.4 kg / 41 x 130 x 115 mm  
Alignable: 0 mm horizontally, 30 mm vertically  
Push-in connection  
0.2 - 4 mm<sup>2</sup> / 0.2 - 2.5 mm<sup>2</sup> / 24 - 12  
0.2 - 2.5 mm<sup>2</sup> / 0.2 - 2.5 mm<sup>2</sup> / 24 - 14  
IP20 / III  
-25 °C ... 70 °C (> 60 °C derating: 2.5%/K)

500 V  
Conformance with EMC Directive 2014/30/EU  
IEC 60950-1/VDE 0805 (SELV)  
EN 50178/VDE 0160 (PELV)  
UL/C-UL listed UL 508 , UL/C-UL Recognized UL 60950

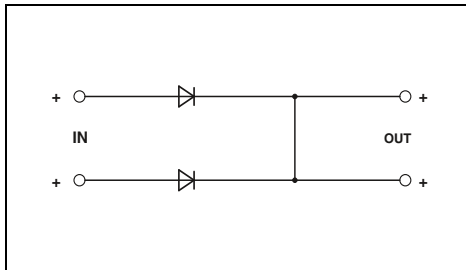

**Technical data**

5 V DC ... 24 V DC  
4.5 V DC ... 30 V DC  
2x 10 A (-25 °C ... 55 °C)  
1x 20 A (-25 °C ... 55 °C)  
-  
Varistor  
0.5 V  
5 W (I<sub>OUT</sub> = 10 A)

0.2 kg / 22.5 x 90 x 84 mm  
Alignable: 0 mm horizontally, 30 mm vertically  
Screw connection  
0.2 - 2.5 mm<sup>2</sup> / 0.2 - 2.5 mm<sup>2</sup> / 24 - 14  
0.2 - 2.5 mm<sup>2</sup> / 0.2 - 2.5 mm<sup>2</sup> / 24 - 14  
IP20 / III  
-25 °C ... 70 °C (> 55 °C derating: 2.5%/K)

500 V  
Conformance with EMC Directive 2014/30/EU  
IEC 60950-1/VDE 0805 (SELV)  
EN 50178/VDE 0160 (PELV)  
UL/C-UL listed UL 508 , UL/C-UL Recognized UL 60950

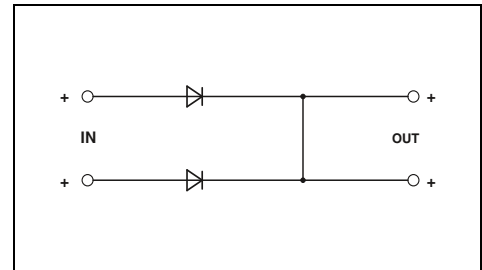

**Technical data**

5 V DC ... 24 V DC  
5 V DC ... 24 V DC  
4.5 V DC ... 30 V DC  
2x 5 A (-25 °C ... 55 °C)  
1x 10 A (-25 °C ... 55 °C)  
-  
Transil diode  
0.5 V  
2.5 W (I<sub>OUT</sub> = 5 A)

0.1 kg / 18 x 90 x 61 mm  
Alignable: 0 mm horizontally, 30 mm vertically  
Screw connection  
0.2 - 2.5 mm<sup>2</sup> / 0.2 - 2.5 mm<sup>2</sup> / 24 - 12  
0.2 - 2.5 mm<sup>2</sup> / 0.2 - 2.5 mm<sup>2</sup> / 24 - 12  
IP20 / III  
-25 °C ... 70 °C (> 55 °C derating: 2.5%/K)

500 V  
Conformance with EMC Directive 2014/30/EU  
IEC 60950-1/VDE 0805 (SELV)  
EN 50178/VDE 0160 (PELV)  
UL/C-UL listed UL 508 , UL/C-UL Recognized UL 60950

**Ordering data**

Type	Order No.	Pcs./Pkt.
TRIO2-DIODE/12-24DC/2X20/1X40	2907379	1

**Ordering data**

Type	Order No.	Pcs./Pkt.
UNO-DIODE/5-24DC/2X10/1X20	2905489	1

**Ordering data**

Type	Order No.	Pcs./Pkt.
STEP-DIODE/5-24DC/2X5/1X10	2868606	1

# Power supplies and UPS

## Accessories for power supplies

### Mounting on S7-300 rail

To supply a SIMATIC® S7-300 controller, QUINT POWER 2.5 A, 5 A, and 10 A are mounted on the S7 rail using a QUINT-PS-ADAPTER-S7.

No further accessories are required for fastening.



	Technical data			Technical data		
Dimensions W x H x D	74 / 130 / 11 mm			104 / 130 / 11 mm		
Material	Aluminum			Aluminum		
	Ordering data			Ordering data		
Description	Type	Order No.	Pcs./Pkt.	Type	Order No.	Pcs./Pkt.
<b>Adapter for S7-300 rail mounting, for:</b> QUINT-PS/1AC/24DC/3.5 QUINT-PS/1AC/24DC/5 QUINT-PS/3AC/24DC/5	<b>QUINT-PS-ADAPTERS7/1</b>	<b>2938196</b>	1			
<b>Adapter for S7-300 rail mounting, for:</b> QUINT-PS/1AC/24DC/10 QUINT-PS/3AC/24DC/10 QUINT-PS/3AC/24DC/20				<b>QUINT-PS-ADAPTERS7/2</b>	<b>2938206</b>	1

### Fan and potential distributor

With the standard power supply mounting position, the temperature range increases by 10 K (max. ambient temperature of 70°C), when the mounting position is rotated, position-dependent derating no longer applies.

– Tool-free mounting

#### Potential distributor

Further modules can be found in Catalog 5, interface technology and switching devices

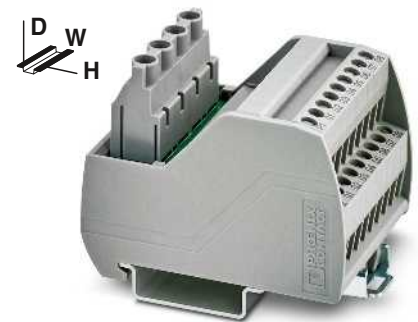

With screw connection and 2 potential levels

	Technical data			Technical data		
Dimensions W x H x D	41 / 27 / 42.2 mm			50 / 65.5 / 50 mm		
	Ordering data			Ordering data		
Description	Type	Order No.	Pcs./Pkt.	Type	Order No.	Pcs./Pkt.
<b>Fan for QUINT POWER SFB, 24 V DC</b>	<b>QUINT-PS/FAN/4</b>	<b>2320076</b>	1			
<b>VARIOFACE module</b> , with two busbars (P1, P2) for potential distribution, per potential: 2 power terminal blocks/8 distributor terminal blocks 2 power terminal blocks/12 distributor terminal blocks 2 power terminal blocks/16 distributor terminal blocks 2 power terminal blocks/24 distributor terminal blocks				<b>VIP-2/SC/PDM-2/16</b> <b>VIP-2/SC/PDM-2/24</b> <b>VIP-2/SC/PDM-2/32</b> <b>VIP-2/SC/PDM-2/48<sup>1)</sup></b>	<b>2315256</b> <b>2315269</b> <b>2315272</b> <b>2903717</b>	1 1 1 1

### Universal wall adapter

Adapter for mounting on even surfaces

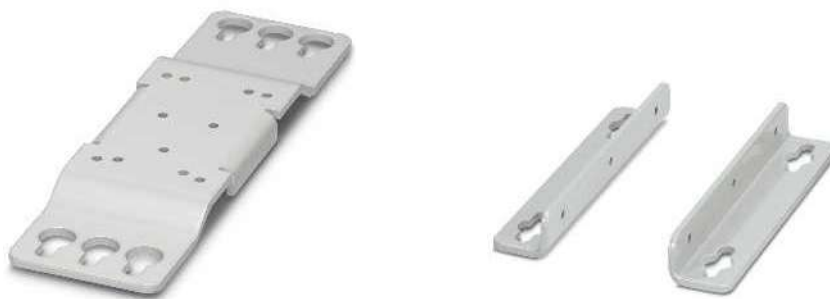

Dimensions W x H x D  
Material

Technical data		
52 / 182 / 9 mm		
Steel, powder-coated		

Technical data		
25 / 130 / 17 mm		
Steel, powder-coated		

Description
<b>Universal wall adapter</b> , for direct wall mounting of the TRIO-PS (from 10 A), QUINT-PS, QUINT-DC-UPS, QUINT-BUFFER power supplies
<b>Universal wall adapter</b> , for direct wall mounting of the QUINT-PS/1AC/24DC/40 and QUINT-UPS/1AC/1AC/500VA power supplies

Ordering data		
Type	Order No.	Pcs./Pkt.
UWA 182/52	2938235	1

Ordering data		
Type	Order No.	Pcs./Pkt.
UWA 130	2901664	1

### Plug-in thermomagnetic circuit breakers

- Device circuit breakers for protecting against overcurrents and short circuits
- SFB characteristic curve enables longer cables and tripping times of < 10 ms
- Maximum ease of maintenance thanks to the two-piece design
- Further circuit breakers can be found on page 307 onwards

**Notes:**  
For additional technical data, drawings, and accessories, please visit [phoenixcontact.net/products](http://phoenixcontact.net/products).



Can be plugged in, SFB characteristic curve

Dimensions W/H/D  
Degree of protection

Technical data		
12.3 mm / 90 mm / 77.3 mm		
IP30 (Actuation area)		

Description	Nominal current
<b>Thermomagnetic circuit breaker</b> , plug-in, 1-pos., signal contact 1 PDT	0.5 A
	1 A
	2 A
	3 A
	4 A
	5 A
	6 A

Ordering data		
Type	Order No.	Pcs./Pkt.
CB TM1 0.5A SFB P	2800835	1
CB TM1 1A SFB P	2800836	1
CB TM1 2A SFB P	2800837	1
CB TM1 3A SFB P	2800838	1
CB TM1 4A SFB P	2800839	1
CB TM1 5A SFB P	2800840	1
CB TM1 6A SFB P	2800841	1

**Base element**, for accommodating CB TM.../CB E... device circuit breakers  
With Push-in connection technology  
With screw connection technology

Accessories		
Type	Order No.	Pcs./Pkt.
CB 1/6-2/4 PT-BE	2800929	10
CB 1/10-1/10 UT-BE	2801305	10



### The intelligent UPS system ensures superior system availability

Uninterruptible power supplies (UPS) continue to deliver power even if the supply network goes down. An uninterruptible solution consists of the three function units shown:

- Power supply
- UPS module
- Energy storage

### QUINT UPS

IQ technology is the key to an intelligent power supply solution. The uninterruptible power supply monitors and optimizes the energy storage. Avoid interruptions when working with the intelligent UPS for non-stop power.

- You know the state of charge and remaining runtime of your energy storage
- You are warned about failures at an early stage and have time to prevent them
- You can maximize the service life of the energy storage
- You can transfer all relevant information to your computer and higher-level controllers

### Practical example

An industrial PC must be continuously supplied with 24 V DC.

#### Previous solution:

The UPS with 3.4 Ah energy storage buffers 24 V DC / 5 A for 20 minutes under optimum conditions.

Can the energy storage actually bridge this time?

The state of charge, performance, and remaining runtime of the energy storage are unknown.

#### Solution with QUINT UPS:

The intelligent UPS determines all relevant energy storage states. This ensures the crucial transparency required to guarantee the stability of the supply and optimum use of the energy storage at all times.

The intelligent battery management detects the current state of charge of the connected energy storage and uses this to calculate the remaining runtime.

The QUINT UPS also indicates whether the buffer time is actually 20 minutes. As soon as an adjustable threshold value is reached, a warning message is sent via the floating relay contact, the software or directly to higher-level controllers. The IPC continues working for as long as possible and is shut down before the battery voltage runs out.

### Space-saving versions

To save space in the control cabinet or to retrofit existing systems easily, UPS versions with integrated energy storage or integrated power supply are recommended.

### Selection guide

Find the right UPS for your application based on the buffer time and load current. Please refer to the color selection tables on pages:

- 272
- 278
- 292

**i** Your web code: #0154



**IQ technology**

The IQ technology is intuitive and provides you with information as soon as it is required.

- Intelligent battery management with SOC (state of charge), detects the current state of charge and the remaining runtime, and SOH (state of health), determines the remaining life expectancy of the energy storage and warns of failure at an early stage
- Intelligent battery control
- Intelligent charging

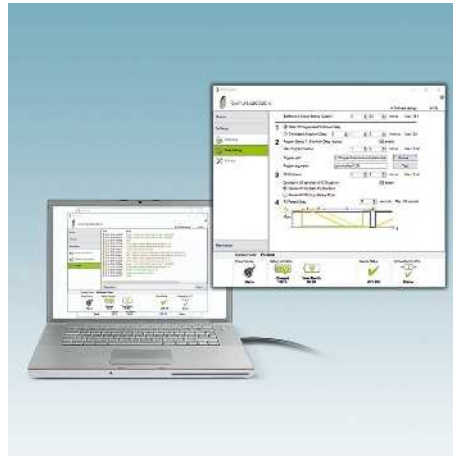

**Signaling and configuration**

The UPS-CONF configuration and management software allows you to monitor and configure your UPS system. The software can be downloaded free of charge at: [phoenixcontact.net/products](http://phoenixcontact.net/products).

- Flexible adaptation of QUINT UPS behavior to individual requirements
- Monitoring and data recorder



**Communication**

The data cables allow you to integrate the UPS module into your application. You can therefore benefit from all the advantages of IQ technology and be kept informed of the state of your UPS solution. The information provided by QUINT UPS can, for example, be forwarded to higher-level controllers via Ethernet or be implemented directly in control solutions from Phoenix Contact.



**AC UPS**

The AC UPS delivers a pure sine curve at the output. The sine generated in battery operation is synchronous with the mains previously used for supply.

**QUINT UPS with IQ technology**

- Optimum use of the buffer time (SOC) and preventive monitoring of the energy storage (SOH)

**TRIO AC UPS**

- Space-saving, as the UPS module and energy storage are combined in one housing



**UPS with integrated energy storage**

Particularly space-saving and easy to retrofit, the UPS module and energy storage are combined in the same housing.

- QUINT UPS: energy storage with lead AGM technology
- STEP UPS: LiPo-based energy storage
- UNO UPS: energy storage with lead AGM technology
- QUINT BUFFER buffer module and QUINT CAP: capacitor-based energy storage



**UPS with integrated power supply**

The UPS module and power supply in a single housing is a space-saving solution.

- Only one energy storage is required to complete the UPS system.
- MINI UPS: for 24 or 12 V DC
- TRIO UPS: for 24 DC

# Power supplies and UPS

## Uninterruptible power supplies

### Selecting the energy storage for QUINT DC-UPS

You can always find the ideal solution for superior system availability with the new modular system for uninterruptible power supplies. The various storage media feature a wide range of different properties: long service life or very long buffer time, no maintenance or use at extreme ambient temperatures. Whatever your requirements, we offer the ideal energy storage.

#### Your advantages

- Fast installation
- Automatic detection of the energy storage by QUINT UPS
  - Tool-free replacement during operation

#### Maximum availability

- Constant communication with QUINT UPS for continuous monitoring and intelligent management

#### Extremely long service life

- Optimum charging characteristic according to the technology and ambient conditions

Type	Buffer time Typical	Temperature	Service life at +20°C	Service life at +50°C	Charging cycles at +20°C	Weight (standardized)
UPS-CAP...	< 5 min	-40 to 60°C	> 20 years	8 years	> 500,000	0.4 kg
UPS-BAT/LI-ION...	> 40 min	-20 to 60°C	15 years	2 years	7,000	0.45 kg
UPS-BAT/VRLA-WTR...	> 5 h	-25 to 60°C	12 years	1.5 years	300	1.3 kg
UPS-BAT/VRLA...	> 8 h	0 to 40°C	6 to 9 years	1 year	250	1 kg



**UPS-BAT/VRLA-WTR...**  
(Valve Regulated Lead Acid/  
Wide Temperature Range)

- Maximum buffer times at extreme temperatures
- Pure lead AGM (Absorbent Glass Mat) technology



**UPS-BAT/LI-ION...**

- Long service life with long buffer times
- Low weight
- Lithium iron phosphate technology

**UPS-CAP (Capacitor)**

- Maximum service life
- Maintenance-free double layer capacitors

**UPS-BAT/VRLA...**  
(Valve Regulated Lead Acid)

- Maximum buffer times
- Lead AGM (Absorbent Glass Mat) technology

### Buffer times for QUINT DC-UPS

#### Buffer times of energy storage devices with double-layer capacitors and lithium iron phosphate and pure lead AGM technology with a large temperature range

Select your **UPS-BAT** and **UPS-CAP** for 24 V DC applications here.

Example: 20 A needs to be buffered for 6 minutes.

Solution:  
UPS-BAT/LI-ION/24DC/120WH

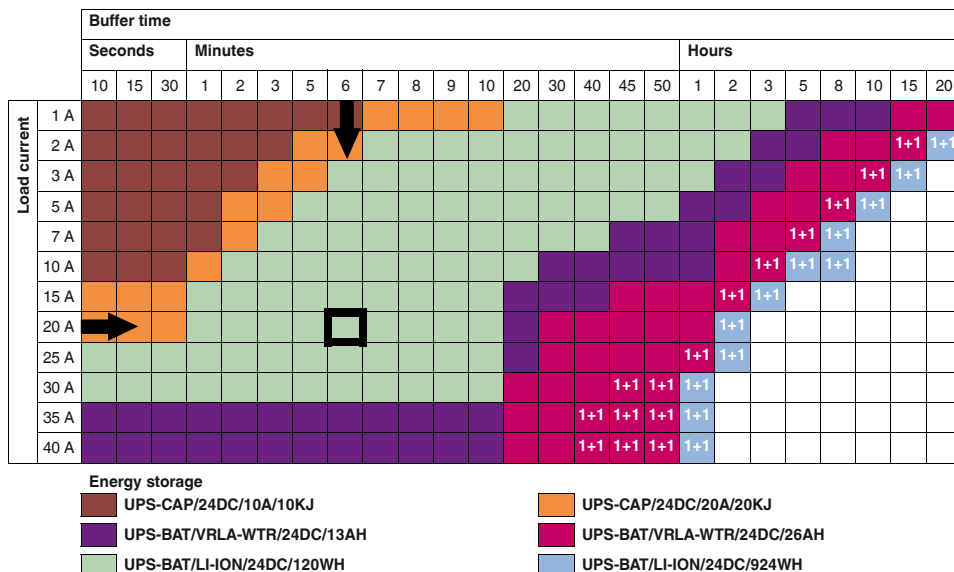

1+1 ... Two energy storage devices of the same capacity are required in this case.  
The data is based on an ambient temperature of +20°C.

#### Buffer times of energy storage devices with lead AGM technology

Select your **UPS-BAT** for 24 V DC applications here.

Example: 20 A needs to be buffered for 10 minutes.

Solution:  
UPS-BAT/VRLA/24DC/12AH

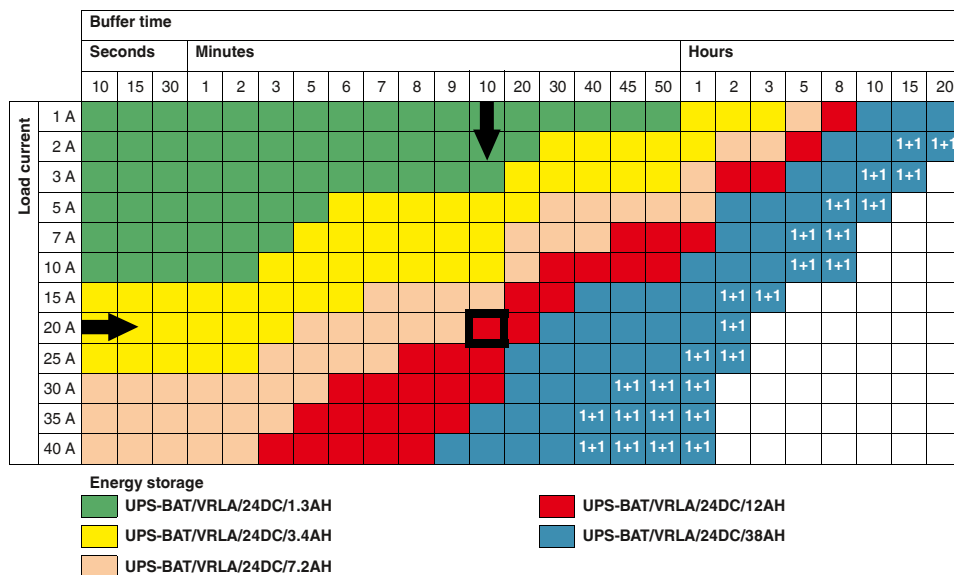

1+1 ... Two energy storage devices of the same capacity are required in this case.  
The data is based on an ambient temperature of +20°C.

# Power supplies and UPS

## Uninterruptible power supplies

### QUINT UPS for DC applications

The UPS module for 24 V DC with output currents ranging from 5 to 40 A allows you to create a custom solution combining power supply, UPS module, and energy storage.

Optimum use of the buffer time and preventive monitoring of the energy storage:

- Detects the current state of charge of the energy storage and calculates the remaining runtime
- Calculates the current life expectancy of the energy storage

Substantial power reserve:

- For mains and battery operation
- Power Boost static power reserve
- Dynamic power reserve with SFB (Selective Fuse Breaking) Technology

Fast battery charging:

- Adaptive current management charges the energy storage twice as fast as before, while simultaneously providing sufficient energy for the loads.

Extensive signaling and parameterization:

- Floating relay contacts
- Data port
- Parameterization with memory module

#### Notes:

The buffer time associated with your solution is dependent on the load current. Exact details for each uninterruptible power supply can be found on page 273.



Uninterruptible power supply,  
24 V DC / 24 V DC, 5 A

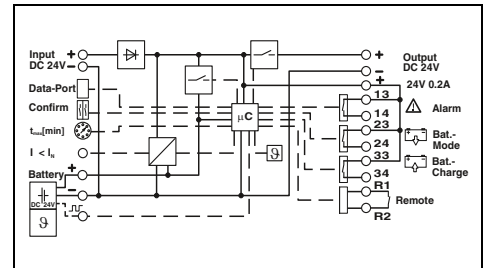

#### Technical data

<b>Input data</b>	24 V DC 18 V DC ... 30 V DC 9.4 A (Maximum, mains operation)
Nominal input voltage range	
Input voltage range	
Max. current consumption	
<b>Output data (mains operation)</b>	24 V DC 18 V DC ... 30 V DC > 98 % (Mains operation, with charged energy storage)
Nominal output voltage	
Output voltage range	
Degree of efficiency	
Output current with convection cooling	5 A (-25 °C ... 60 °C) 30 A (-25 °C ... 60 °C) 7.5 A (-25 °C ... 40 °C)
- Nominal output current $I_N$ (continual)	
- SFB Technology (12 ms)	
- Power Boost $I_{Boost}$ (continual)	
<b>Output data (battery operation)</b>	24 V DC 19.2 V DC ... 27.6 V DC ( $U_{OUT} = U_{BAT} - 0.5 \text{ V DC}$ )
Nominal output voltage	
Output voltage range	
Output current with convection cooling	32.5 A (-25 °C ... 60 °C) 7.5 A (-25 °C ... 40 °C)
- SFB Technology (15 ms)	
- Power Boost $I_{Boost}$ (continual)	
<b>Energy storage</b>	24 V DC 24 V DC ... 29 V DC (temperature compensated) 0.8 Ah ... 140 Ah 0.2 A ... 1.36 A
Nominal voltage $U_N$	
End-of-charge voltage	
Nominal capacity range	
Max. charging current	
<b>Signaling</b>	LED, relay contact, interface/software IFS (Interface system data port)
Signaling	
Interfaces	
<b>General data</b>	0.5 kg / 35 x 130 x 125 mm Plug-in screw connection 0.2 - 2.5 mm <sup>2</sup> / 0.2 - 2.5 mm <sup>2</sup> / 20 - 12 0.2 - 2.5 mm <sup>2</sup> / 0.2 - 2.5 mm <sup>2</sup> / 20 - 12 0.2 - 2.5 mm <sup>2</sup> / 0.2 - 2.5 mm <sup>2</sup> / 24 - 12 IP20 / III -25 °C ... 70 °C -40 °C ... 85 °C 60 °C ... 70 °C (2.5%/K) ≤ 95 % (25 °C, non-condensing)
Weight / Dimensions W x H x D	
Connection method	
Input connection data (solid/stranded/AWG)	
Output connection data (solid/stranded/AWG)	
Signal connection data (solid/stranded/AWG)	
Degree of protection / Protection class	
Ambient temperature (operation)	
Ambient temperature (storage/transport)	
Derating	
Max. permissible relative humidity (operation)	
<b>Standards/regulations</b>	UL Listed UL 508 , UL/C-UL Recognized UL 60950 , UL ANSI/ISA-12.12.01 Class I, Division 2, Groups A, B, C, D (Hazardous Location)
UL approvals	

#### Ordering data

Description	Type	Order No.	Pcs./Pkt.
Power supply, uninterruptible	QUINT-UPS/24DC/24DC/5	2320212	1



H  
D W

IQ  
TECHNOLOGY

SFB  
TECHNOLOGY

Uninterruptible power supply,  
24 V DC / 24 V DC, 10 A



H  
D W

IQ  
TECHNOLOGY

SFB  
TECHNOLOGY

Uninterruptible power supply,  
24 V DC / 24 V DC, 20 A



H  
D W

IQ  
TECHNOLOGY

SFB  
TECHNOLOGY

Uninterruptible power supply,  
24 V DC / 24 V DC, 40 A

UL US ENEC DNV GL  
Ex:

UL US ENEC DNV GL  
Ex:

UL US ENEC DNV GL  
Ex:

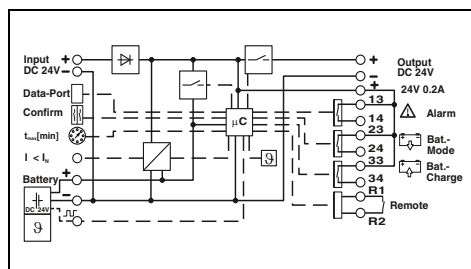
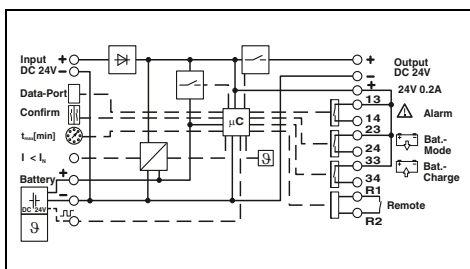
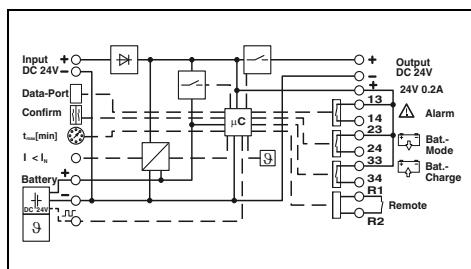

Technical data

Technical data

Technical data

24 V DC  
18 V DC ... 30 V DC  
19 A (Maximum, mains operation)

24 V DC  
18 V DC ... 30 V DC  
32.9 A (Maximum, mains operation)

24 V DC  
18 V DC ... 30 V DC  
51.9 A (Maximum, mains operation)

24 V DC  
18 V DC ... 30 V DC  
> 98 % (Mains operation, with charged energy storage)

24 V DC  
18 V DC ... 30 V DC  
> 98 % (Mains operation, with charged energy storage)

24 V DC  
18 V DC ... 30 V DC  
> 99 % (Mains operation, with charged energy storage)

10 A (-25 °C ... 60 °C)  
60 A (-25 °C ... 60 °C)  
15 A (-25 °C ... 40 °C)

20 A (-25 °C ... 60 °C)  
120 A (-25 °C ... 60 °C)  
26 A (-25 °C ... 40 °C)

40 A (-25 °C ... 50 °C)  
215 A (-25 °C ... 60 °C)  
45 A (-25 °C ... 40 °C)

24 V DC  
19.2 V DC ... 27.6 V DC ( $U_{OUT} = U_{BAT} - 0.5 V DC$ )

24 V DC  
19.2 V DC ... 27.6 V DC ( $U_{OUT} = U_{BAT} - 0.5 V DC$ )

24 V DC  
19.2 V DC ... 27.6 V DC ( $U_{OUT} = U_{BAT} - 0.5 V DC$ )

65 A (-25 °C ... 60 °C)  
15 A (-25 °C ... 40 °C)

120 A (-25 °C ... 60 °C)  
27 A (-25 °C ... 40 °C)

215 A (-25 °C ... 60 °C)  
45 A (-25 °C ... 40 °C)

24 V DC  
24 V DC ... 29 V DC (temperature compensated)  
1.3 Ah ... 140 Ah  
0.2 A ... 2.88 A

24 V DC  
24 V DC ... 29 V DC (temperature compensated)  
3 Ah ... 200 Ah  
0.2 A ... 5 A

24 V DC  
24 V DC ... 29 V DC (temperature compensated)  
7 Ah ... 200 Ah  
0.2 A ... 5 A

LED, relay contact, interface/software  
IFS (Interface system data port)

LED, relay contact, interface/software  
IFS (Interface system data port)

LED, relay contact, interface/software  
IFS (Interface system data port)

0.5 kg / 35 x 130 x 125 mm  
Plug-in screw connection  
0.2 - 2.5 mm<sup>2</sup> / 0.2 - 2.5 mm<sup>2</sup> / 16 - 12  
0.2 - 2.5 mm<sup>2</sup> / 0.2 - 2.5 mm<sup>2</sup> / 16 - 12  
0.2 - 2.5 mm<sup>2</sup> / 0.2 - 2.5 mm<sup>2</sup> / 24 - 12  
IP20 / III  
-25 °C ... 70 °C  
-40 °C ... 85 °C  
60 °C ... 70 °C (2.5%/K)  
≥ 95 % (25°C, non-condensing)

0.6 kg / 40 x 130 x 125 mm  
Screw connection  
0.2 - 6 mm<sup>2</sup> / 0.2 - 4 mm<sup>2</sup> / 12 - 10  
0.2 - 6 mm<sup>2</sup> / 0.2 - 4 mm<sup>2</sup> / 12 - 10  
0.2 - 4 mm<sup>2</sup> / 0.2 - 2.5 mm<sup>2</sup> / 24 - 12  
IP20 / III  
-25 °C ... 70 °C  
-40 °C ... 85 °C  
60 °C ... 70 °C (2.5%/K)  
≤ 95 % (25°C, non-condensing)

0.7 kg / 47 x 130 x 125 mm  
Screw connection  
0.5 - 16 mm<sup>2</sup> / 0.5 - 16 mm<sup>2</sup> / 8 - 6  
0.5 - 16 mm<sup>2</sup> / 0.5 - 16 mm<sup>2</sup> / 8 - 6  
0.2 - 4 mm<sup>2</sup> / 0.2 - 2.5 mm<sup>2</sup> / 24 - 12  
IP20 / III  
-25 °C ... 70 °C  
-40 °C ... 85 °C  
60 °C ... 70 °C (2.5%/K)  
≤ 95 % (25°C, non-condensing)

UL Listed UL 508 , UL/C-UL Recognized UL 60950 ,  
UL ANSI/ISA-12.12.01 Class I, Division 2, Groups A, B, C, D  
(Hazardous Location)

UL Listed UL 508 , UL/C-UL Recognized UL 60950 ,  
UL ANSI/ISA-12.12.01 Class I, Division 2, Groups A, B, C, D  
(Hazardous Location)

UL Listed UL 508 , UL/C-UL Recognized UL 60950 ,  
UL ANSI/ISA-12.12.01 Class I, Division 2, Groups A, B, C, D  
(Hazardous Location)

Ordering data

Ordering data

Ordering data

Type	Order No.	Pcs./Pkt.
QUINT-UPS/ 24DC/ 24DC/10	2320225	1

Type	Order No.	Pcs./Pkt.
QUINT-UPS/ 24DC/ 24DC/20	2320238	1

Type	Order No.	Pcs./Pkt.
QUINT-UPS/ 24DC/ 24DC/40	2320241	1

# Power supplies and UPS

## Uninterruptible power supplies

### QUINT UPS for DC applications with dual output voltage

The UPS module for two output voltages, 12 and 24 V DC, allows you to create a custom solution combining power supply, UPS module, and energy storage.

- Flexible and space-saving thanks to the two output voltages in one unit

Optimum use of the buffer time and preventive monitoring of the energy storage:

- Detects the current state of charge of the energy storage and calculates the remaining runtime
- Calculates the current life expectancy of the energy storage

Substantial power reserve:

- For mains and battery operation
- Power Boost static power reserve
- Dynamic power reserve with SFB (Selective Fuse Breaking) Technology

Fast battery charging:

- Adaptive current management charges the energy storage twice as fast as before, while simultaneously providing sufficient energy for the loads.

Extensive signaling and parameterization:

- Floating relay contacts
- Data port
- Parameterization with memory module

#### Notes:

The buffer time associated with your solution is dependent on the load current. Exact details for each uninterruptible power supply can be found on page 273.



Uninterruptible power supply, 24 V DC/12 V DC, 5 A and 24 V DC, 10 A

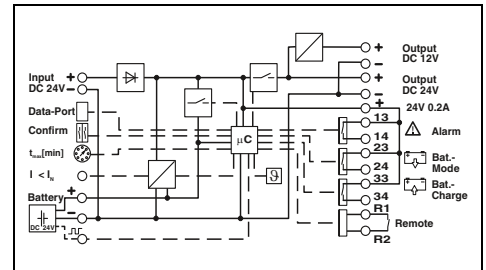

#### Technical data

Input data	
Input voltage	24 V DC
Input voltage range	18 V DC ... 30 V DC
Max. current consumption	16 A
Output data (mains operation)	
Nominal output voltage	24 V DC
Output voltage range	24 V DC
Efficiency (typ.)	> 93 % (Mains operation, with charged energy storage)
Output current with convection cooling ( $P_{max} = P_{12V} + P_{24V} = 360\text{ W}$ )	
- Nominal output current $I_N$ (continual)	5 A (-25 °C ... 60 °C)
- SFB Technology (15 ms)	-
- Power Boost $I_{Boost}$ (continual)	7.5 A (-25 °C ... 40 °C)
Output data (battery operation)	
Nominal output voltage	24 V DC
Output voltage range	24 V DC
Output current with convection cooling ( $P_{max} = P_{12V} + P_{24V} = 360\text{ W}$ )	
- Nominal output current $I_N$ (continual)	5 A (-25 °C ... 60 °C)
- SFB Technology (15 ms)	-
- Power Boost $I_{Boost}$ (continual)	7.5 A (-25 °C ... 40 °C)
Energy storage	
Nominal voltage $U_N$	24 V DC
End-of-charge voltage	24 V DC ... 29 V DC (temperature compensated)
Nominal capacity range	1.3 Ah ... 140 Ah
Max. charging current	0.2 A ... 2.88 A
Signaling	
Signaling	LED, relay contact, interface/software
Interfaces	IFS (Interface system data port)
General data	
Weight / Dimensions W x H x D	0.6 kg / 35 x 130 x 125 mm
Connection method	Plug-in screw connection
Connection data input/output solid/stranded/AWG	0.2 - 2.5 mm <sup>2</sup> / 0.2 - 2.5 mm <sup>2</sup> / 16 - 12
Signal connection data (solid/stranded/AWG)	0.2 - 2.5 mm <sup>2</sup> / 0.2 - 2.5 mm <sup>2</sup> / 24 - 12
Degree of protection / Protection class	IP20 / III
Ambient temperature (operation)	-25 °C ... 70 °C
Derating	60 °C ... 70 °C (2.5%/K)
Standards/regulations	
UL approvals	UL Listed UL 508, UL/C-UL Recognized UL 60950

24 V DC	
18 V DC ... 30 V DC	
16 A	
12 V DC	24 V DC
12 V DC	24 V DC
	18 V DC ... 30 V DC
	( $U_{OUT} = U_{IN} - 0.5\text{ V DC}$ )
> 93 % (Mains operation, with charged energy storage)	> 98 % (Mains operation, with charged energy storage)
5 A (-25 °C ... 60 °C)	10 A (-25 °C ... 60 °C)
-	60 A (-25 °C ... 60 °C)
7.5 A (-25 °C ... 40 °C)	15 A (-25 °C ... 40 °C)
12 V DC	24 V DC
12 V DC	24 V DC
-	19.2 V DC ... 27.6 V DC
	( $U_{OUT} = U_{BAT} - 0.5\text{ V DC}$ )
5 A (-25 °C ... 60 °C)	10 A (-25 °C ... 60 °C)
-	65 A (-25 °C ... 60 °C)
7.5 A (-25 °C ... 40 °C)	15 A (-25 °C ... 40 °C)
24 V DC	
24 V DC ... 29 V DC (temperature compensated)	
1.3 Ah ... 140 Ah	
0.2 A ... 2.88 A	
LED, relay contact, interface/software	
IFS (Interface system data port)	
0.6 kg / 35 x 130 x 125 mm	
Plug-in screw connection	
0.2 - 2.5 mm <sup>2</sup> / 0.2 - 2.5 mm <sup>2</sup> / 16 - 12	
0.2 - 2.5 mm <sup>2</sup> / 0.2 - 2.5 mm <sup>2</sup> / 24 - 12	
IP20 / III	
-25 °C ... 70 °C	
60 °C ... 70 °C (2.5%/K)	
UL Listed UL 508, UL/C-UL Recognized UL 60950	

#### Ordering data

Description	
Power supply, uninterruptible	

Type	Order No.	Pcs./Pkt.
QUINT-UPS/ 24DC/12DC/5/24DC/10	2320461	1



# Power supplies and UPS

## Uninterruptible power supplies

### Selecting the energy storage for AC-UPS

You can always find the ideal solution for superior system availability with the new modular system for uninterruptible power supplies. The various storage media feature a wide range of different properties: long service life or very long buffer time, no maintenance or use at extreme ambient temperatures. Whatever your requirements, we offer the ideal energy storage.

#### Your advantages

- Fast installation
  - Automatic detection of the energy storage by QUINT UPS
  - Tool-free replacement during operation
- Maximum availability
  - Constant communication with QUINT UPS for continuous monitoring and intelligent management
- Extremely long service life
  - Optimum charging characteristic according to the technology and ambient conditions

Type	Buffer time Typical	Temperature	Service life at +20°C	Service life at +50°C	Charging cycles at +20°C	Weight (standardized)
UPS-CAP...	< 5 min	-40 to 60°C	> 20 years	8 years	> 500,000	0.4 kg
UPS-BAT/LI-ION...	> 40 min	-20 to 60°C	15 years	2 years	7,000	0.45 kg
UPS-BAT/VRLA-WTR...	> 5 h	-25 to 60°C	12 years	1.5 years	300	1.3 kg
UPS-BAT/VRLA...	> 8 h	0 to 40°C	6 to 9 years	1 year	250	1 kg

### Buffer times for QUINT AC-UPS

#### Buffer times of energy storage devices with double-layer capacitors and lithium iron phosphate and pure lead AGM technology with a large temperature range

Select the **UPS-BAT** and **UPS-CAP** for your QUINT AC-UPS / 500 VA (120/230 V AC applications) here.

Example: 125 W needs to be buffered for one hour.

Solution:  
UPS-BAT/VRLA-WTR/24DC/26AH

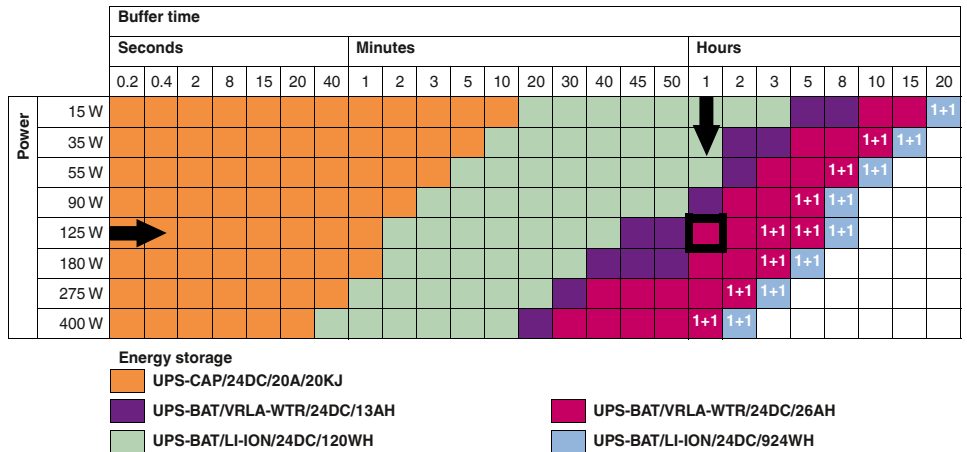

Select the **UPS-BAT** for your QUINT AC-UPS / 1000 VA (120/230 V AC applications) here.

Example: 400 W needs to be buffered for three hours.

Solution:  
2x UPS-BAT/LI-ION/24DC/924WH

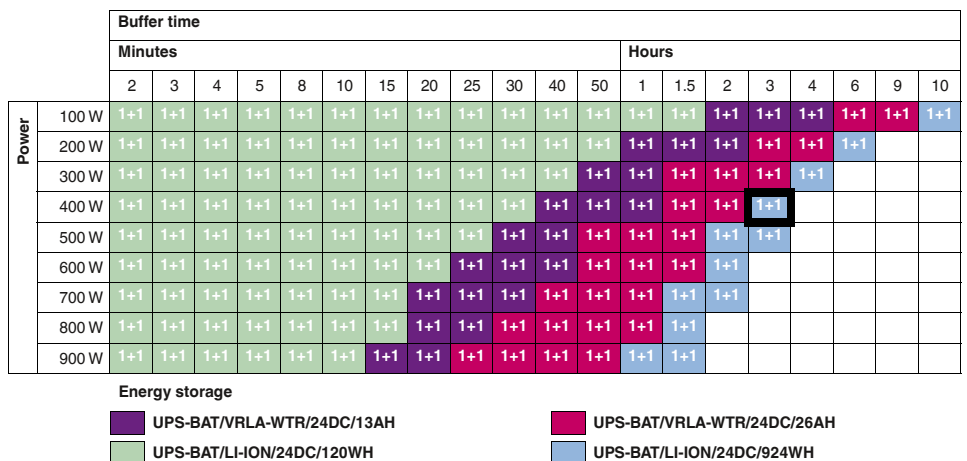

1+1 ... Two energy storage devices of the same capacity are required in this case. The data is based on an ambient temperature of +20°C.



# Power supplies and UPS

## Uninterruptible power supplies

### QUINT UPS for AC applications

The QUINT UPS delivers a pure sine curve at the output for AC applications. The sine generated in battery operation is synchronous with the mains previously used for supply. The QUINT AC-UPS for 120 V AC/230 V AC with 400 W/500 VA power can be combined with all UPS-CAP and UPS-BAT energy storage devices.

Optimum use of the buffer time and preventive monitoring of the energy storage:

- Detects the current state of charge of the energy storage and calculates the remaining runtime
- Calculates the current life expectancy of the energy storage

Worldwide use:

- Input voltages from 96 to 264 V AC
- Storage of the level and frequency of the input voltage, in the event of mains failure, the output is automatically supplied with 120 V AC/60 Hz or 230 V AC/50 Hz
- Manual voltage pre-selection possible

Maximum energy efficiency:

- Offline operation: 98% efficiency for charged energy storage
- Power factor  $\cos \phi$  0.8

Extensive signaling and parameterization:

- Switching outputs
- USB interface
- Data port
- Parameterization with memory module

Simplified startup:

- The UPS can be switched on without a power supply network (cold restart)

#### Notes:

The buffer time associated with your solution is dependent on the load current. Exact details for each uninterruptible power supply can be found on page 278



Uninterruptible power supply,  
1 AC / 1 AC, 500 VA

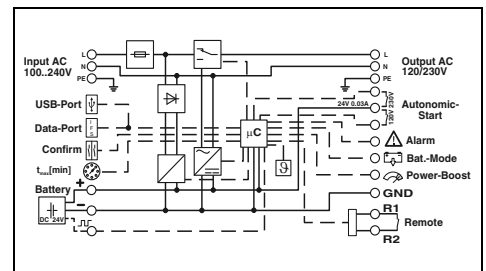

#### Technical data

General input data	
Input voltage range	180 V AC ... 264 V AC
Frequency range	45 Hz ... 65 Hz
Activation threshold	$U_N \pm 10\%$ . Can be configured using UPS-CONF software.
Input data	
Nominal input voltage	120 V AC                      230 V AC
Input voltage range AC	120 V AC                      230 V AC
Nominal frequency	102 V AC ... 138 V AC      196 V AC ... 264 V AC
Max. current consumption ( $I_N = I_{CHARGE} + I_{BOOST}$ )	50 Hz ... 60 Hz              50 Hz ... 60 Hz
General output data	
Nominal power / Apparent power	400 W / 500 VA
Derating	> 50 °C ... 70 °C (2.5%/K)
Switch-over time	< 10 ms
Efficiency (typ.)	> 98 % (Mains operation)
Output data (mains operation)	
Nominal output voltage	120 V AC                      230 V AC
Output voltage range	120 V AC                      230 V AC
- Nominal output current $I_N$ (continual)	102 V AC ... 138 V AC      196 V AC ... 264 V AC
- Power Boost $I_{BOOST}$ (continual)	4.3 A (-25 °C ... 70 °C)    2.2 A (-25 °C ... 70 °C)
Output data (battery operation)	5.2 A (-25 °C ... 70 °C)    2.7 A (-25 °C ... 70 °C)
Nominal output voltage	120 V AC                      230 V AC
Nominal output voltage	120 V AC                      230 V AC
- Nominal output current $I_N$ (continual)	4.3 A (-25 °C ... 50 °C)    2.2 A (-25 °C ... 50 °C)
- Power Boost $I_{BOOST}$ (5 s)	5.2 A (-25 °C ... 50 °C)    2.7 A (-25 °C ... 50 °C)
Energy storage	
Nominal voltage $U_N$	24 V DC
End-of-charge voltage	25 V DC ... 30 V DC (temperature compensated)
Nominal capacity range	3 Ah ... 200 Ah
Max. charging current	0.2 A ... 2 A
Signaling	
Signaling	LED, active switching outputs, interface/software
Interfaces	
General data	
Classification according to IEC 62040-3	VFD-SS-311
Weight / Dimensions W x H x D	2.2 kg / 125 x 130 x 125 mm
Connection method	Screw connection
Connection data input/output solid/stranded/AWG	1.5 - 6 mm <sup>2</sup> / 1.5 - 4 mm <sup>2</sup> / 18 - 10
Signal connection data (solid/stranded/AWG)	0.2 - 2.5 mm <sup>2</sup> / 0.2 - 2.5 mm <sup>2</sup> / 24 - 10
Degree of protection / Protection class	IP20 / I
Ambient temperature (operation)	-25 °C ... 70 °C (> 50 °C derating: 2.5%/K)
Standards/regulations	
UL approvals	UL/C-UL Recognized UL 1778

Technical data		
180 V AC ... 264 V AC		
45 Hz ... 65 Hz		
$U_N \pm 10\%$ . Can be configured using UPS-CONF software.		
120 V AC	230 V AC	
120 V AC	230 V AC	
102 V AC ... 138 V AC	196 V AC ... 264 V AC	
50 Hz ... 60 Hz	50 Hz ... 60 Hz	
6.8 A	3.7 A	
400 W / 500 VA		
> 50 °C ... 70 °C (2.5%/K)		
< 10 ms		
> 98 % (Mains operation)		
120 V AC	230 V AC	
120 V AC	230 V AC	
102 V AC ... 138 V AC	196 V AC ... 264 V AC	
4.3 A (-25 °C ... 70 °C)	2.2 A (-25 °C ... 70 °C)	
5.2 A (-25 °C ... 70 °C)	2.7 A (-25 °C ... 70 °C)	
120 V AC	230 V AC	
120 V AC	230 V AC	
4.3 A (-25 °C ... 50 °C)	2.2 A (-25 °C ... 50 °C)	
5.2 A (-25 °C ... 50 °C)	2.7 A (-25 °C ... 50 °C)	
24 V DC		
25 V DC ... 30 V DC (temperature compensated)		
3 Ah ... 200 Ah		
0.2 A ... 2 A		
LED, active switching outputs, interface/software		
IFS (Interface system data port) , MINI-USB type B		
VFD-SS-311		
2.2 kg / 125 x 130 x 125 mm		
Screw connection		
1.5 - 6 mm <sup>2</sup> / 1.5 - 4 mm <sup>2</sup> / 18 - 10		
0.2 - 2.5 mm <sup>2</sup> / 0.2 - 2.5 mm <sup>2</sup> / 24 - 10		
IP20 / I		
-25 °C ... 70 °C (> 50 °C derating: 2.5%/K)		
UL/C-UL Recognized UL 1778		

#### Ordering data

Description	<b>Power supply, uninterruptible</b>
-------------	--------------------------------------

Type	Order No.	Pcs./Pkt.
QUINT-UPS/ 1AC/ 1AC/500VA	2320270	1

new



Uninterruptible power supply,  
1 AC / 1 AC, 1 KVA

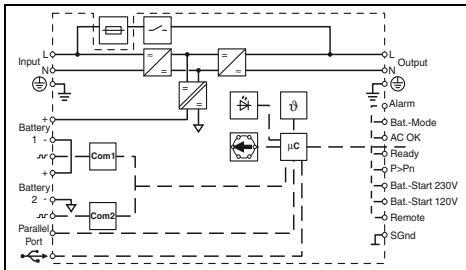

**Technical data**

96 V AC ... 264 V AC  
45 Hz ... 65 Hz  
Can be configured using UPS-CONF software

120 V AC	230 V AC
120 V AC	230 V AC
96 V AC ... 144 V AC	184 V AC ... 264 V AC
60 Hz	50 Hz
13 A	7 A

900 W / 1000 VA  
> 60 °C (2.5 %/K)  
0 ms  
> 92 % (with charged energy storage)

120 V AC	230 V AC
120 V AC	230 V AC
8.3 A (-25 °C ... 70 °C)	4.4 A (-25 °C ... 70 °C)
13 A (-25 °C ... 70 °C)	7 A (-25 °C ... 70 °C)
120 V AC	230 V AC
120 V AC	230 V AC
8.3 A (-25 °C ... 70 °C)	4.4 A (-25 °C ... 70 °C)
13 A (-25 °C ... 70 °C)	7 A (-25 °C ... 70 °C)

2x 24 V DC  
50 V DC ... 60 V DC (temperature compensated)  
7.2 Ah ... 190 Ah  
5 A

LED, active switching output

MINI-USB type B, lockable

VFI-SS-111  
5 kg / 290 x 130 x 125 mm  
Screw connection  
0.2 - 6 mm<sup>2</sup> / 0.2 - 4 mm<sup>2</sup> / 30 - 10  
0.2 - 1.5 mm<sup>2</sup> / 0.2 - 1.5 mm<sup>2</sup> / 24 - 16  
IP20 / I  
-40 °C ... 70 °C (> 60 °C derating: 2.5%/K)

UL/C-UL Recognized UL 1778

**Ordering data**

Type	Order No.	Pcs./Pkt.
QUINT4-UPS/1AC/1AC/1KVA	2320283	1

# Power supplies and UPS

## Uninterruptible power supplies

### TRIO UPS for AC applications

The TRIO UPS delivers a pure sine curve at the output for AC applications. The sine generated in battery operation is synchronous with the mains previously used for supply. Supply AC loads reliably with the new TRIO-UPS-2G uninterruptible power supplies for the DIN rail.

- Space-saving: UPS module and energy storage are combined in one housing
- Long buffer times with integrated VRLA energy storage, can be extended with additional energy storage
- USB interface for connection to higher-level controllers, such as industrial PCs
- Startup from energy storage possible, even without mains input



Uninterruptible power supply,  
1 AC / 1 AC, 750 VA



Uninterruptible power supply,  
1 AC / 1 AC, 750 VA

CB

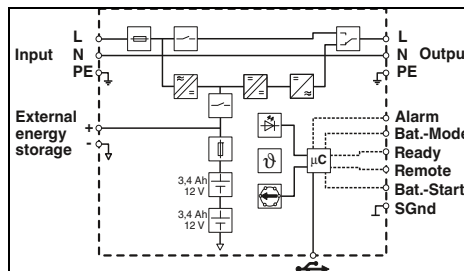

#### Technical data

Input data	
Input voltage range	184 V AC ... 264 V AC
Frequency range	45 Hz ... 55 Hz
Max. current consumption	3 A
General output data	
Input fuse	10 A 400 V gRL
General output data	
Apparent power / Nominal power	750 VA / 600 W
Switch-over time	< 10 ms
Efficiency	> 95 % (with charged energy storage)
Classification according to IEC 62040-3	VFD-SS-311
Output data (mains operation)	
Nominal output voltage	230 V AC
Output current	3 A
Output data (battery operation)	
Nominal output voltage	230 V AC
Output current	3 A
Form of output voltage	Pure sine
Energy storage	
Accumulator type	2x Panasonic UP-VW1220P1
Buffer period	20 min. (100 W) / 4 min. (300 W) / 1 min. (600 W)
Signaling	
LED signaling	AC OK, Alarm, Battery Mode
Transistor switching output	Alarm, Battery Mode, Ready
Floating signal contact	-
General data	
Weight / Dimensions W x H x D	5.7 kg / 210 x 170 x 136 mm
Connection method	Push-in connection
Input connection data (solid/stranded/AWG)	0.2 - 4 mm <sup>2</sup> / 0.2 - 2.5 mm <sup>2</sup> / 24 - 12
Output connection data (solid/stranded/AWG)	0.2 - 4 mm <sup>2</sup> / 0.2 - 2.5 mm <sup>2</sup> / 24 - 12
Output connection battery	0.2 - 10 mm <sup>2</sup> / 0.2 - 6 mm <sup>2</sup> / 24 - 8
Signal connection data (solid/stranded/AWG)	0.2 - 1.5 mm <sup>2</sup> / 0.2 - 1.5 mm <sup>2</sup> / 24 - 16
Degree of protection / Protection class	IP20 / I
MTBF (IEC 61709, SN 29500)	-
Ambient temperature (operation)	0 °C ... 40 °C
Ambient temperature (storage/transport)	-15 °C ... 40 °C (with charged energy storage)

Standards/regulations  
UL approvals

Description  
**Power supply**, uninterruptible

CB

UL

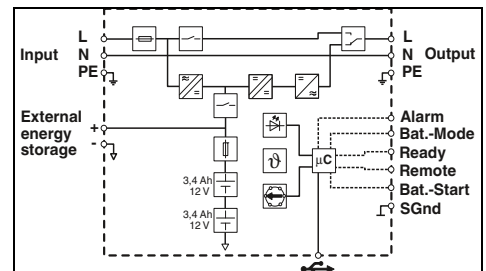

#### Technical data

Input data	
Input voltage range	96 V AC ... 138 V AC
Frequency range	55 Hz ... 65 Hz
Max. current consumption	6 A
General output data	
Input fuse	10 A 400 V gRL
General output data	
Apparent power / Nominal power	750 VA / 600 W
Switch-over time	< 10 ms
Efficiency	> 95 % (with charged energy storage)
Classification according to IEC 62040-3	VFD-SS-311
Output data (mains operation)	
Nominal output voltage	120 V AC
Output current	6 A
Output data (battery operation)	
Nominal output voltage	120 V AC
Output current	6 A
Form of output voltage	Pure sine
Energy storage	
Accumulator type	2x Panasonic UP-VW1220P1
Buffer period	20 min. (100 W) / 4 min. (300 W) / 1 min. (600 W)
Signaling	
LED signaling	AC OK, Alarm, Battery Mode
Transistor switching output	Alarm, Battery Mode, Ready
Floating signal contact	-
General data	
Weight / Dimensions W x H x D	5.7 kg / 210 x 170 x 136 mm
Connection method	Push-in connection
Input connection data (solid/stranded/AWG)	0.2 - 4 mm <sup>2</sup> / 0.2 - 2.5 mm <sup>2</sup> / 24 - 12
Output connection data (solid/stranded/AWG)	0.2 - 4 mm <sup>2</sup> / 0.2 - 2.5 mm <sup>2</sup> / 24 - 12
Output connection battery	0.2 - 10 mm <sup>2</sup> / 0.2 - 6 mm <sup>2</sup> / 24 - 8
Signal connection data (solid/stranded/AWG)	0.2 - 1.5 mm <sup>2</sup> / 0.2 - 1.5 mm <sup>2</sup> / 24 - 16
Degree of protection / Protection class	IP20 / I
MTBF (IEC 61709, SN 29500)	-
Ambient temperature (operation)	0 °C ... 40 °C
Ambient temperature (storage/transport)	-15 °C ... 40 °C (with charged energy storage)

UL/C-UL Recognized UL 1778

Description  
**Power supply**, uninterruptible

#### Ordering data

Type	Order No.	Pcs./Pkt.
TRIO-UPS-2G/1AC/1AC/230V/750VA	2905909	1

#### Ordering data

Type	Order No.	Pcs./Pkt.
TRIO-UPS-2G/1AC/1AC/120V/750VA	2905908	1

USB data cable

**MINI-SCREW-USB-DATACABLE**

- For communication between the uninterruptible power supply and the UPS CONF configuration software
- Can be locked according to UL requirements



Description
<b>Data cable</b> for communication between higher-level controllers and uninterruptible power supplies
Cable length: 3 m

Ordering data		
Type	Order No.	Pcs./Pkt.
MINI-SCREW-USB-DATACABLE	2908217	1

# Power supplies and UPS

## Uninterruptible power supplies

### Energy storage for QUINT UPS

#### Maintenance-free CAP UPS

- Double-layer capacitors
- Life expectancy:  
  - > 20 years (20°C), > 8 years (50°C)
- Communication with QUINT UPS
- Integrated temperature sensor
- Works reliably, even under extreme ambient temperatures of -40°C to +60°C



Maintenance-free energy storage,  
24 V DC, 10 A, 10 kJ

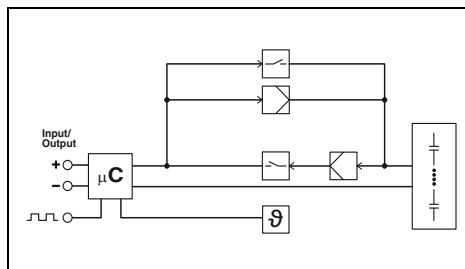

#### Technical data

Input data
Nominal capacity
Output data
Nominal output voltage
Output voltage range
Output current
Output fuse
Can be connected in parallel/series
Buffer period
General data
Storage medium
Weight / Dimensions W x H x D
Degree of protection / Protection class
Ambient temperature (operation)
Ambient temperature (storage/transport)
Service life
Standards/regulations
UL approvals

0.1 Ah
24 V DC
22 V DC ... 27 V DC
10 A
1x 25 A (internal)
No / No
6 min. (1 A) / 33 s (10 A)
Double-layer capacitor
1.7 kg / 126 x 130 x 126 mm
IP20 / III
-40 °C ... 60 °C
-40 °C ... 60 °C
20 years (20 °C)
UL/C-UL Recognized UL 60950

#### Ordering data

Description
<b>Energy storage</b>

Type	Order No.	Pcs./Pkt.
UPS-CAP/24DC/10A/10KJ	2320377	1



Maintenance-free energy storage,  
24 V DC, 20 A, 20 kJ

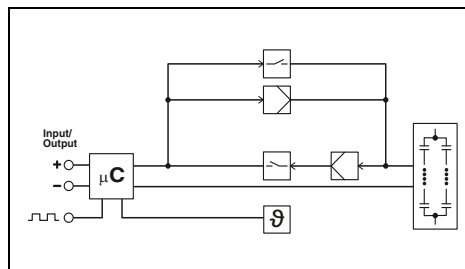

#### Technical data

0.2 Ah
24 V DC
22 V DC ... 27 V DC
20 A
2x 25 A (internal)
No / No
12 min. (1 A) / 33 s (20 A)
Double-layer capacitor
2.9 kg / 150 x 130 x 176 mm
IP20 / III
-40 °C ... 60 °C
-40 °C ... 60 °C
20 years (20 °C)
UL/C-UL Recognized UL 60950

#### Ordering data

Type	Order No.	Pcs./Pkt.
UPS-CAP/24DC/20A/20KJ	2320380	1

new

Energy storage for QUINT UPS

UPS-BAT/LI-ION for long service life with long buffer times

- Lithium iron phosphate technology
- Works reliably, even under extreme ambient temperatures of -20 to +60°C
- Communication with QUINT UPS
- Integrated temperature sensor for optimum charging
- Battery can be changed without tools

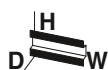

LI-ION energy storage, 120 Wh



LI-ION energy storage, 924 Wh

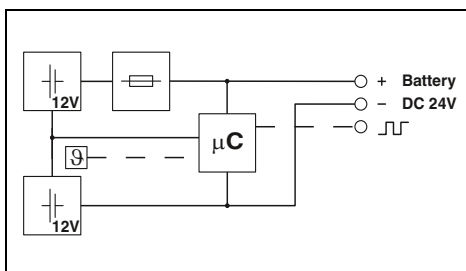

Technical data

Input data/output data
Nominal input voltage
Nominal capacity
Output current
Output fuse
Can be connected in parallel/series
Buffer period

24 V DC
120 Wh
30 A
1x 30 A ATOF 32V (breaking capacity 1000 A)
Yes / No
14 min. (20 A)

General data
Storage medium
Weight / Dimensions W x H x D
Degree of protection / Protection class
Ambient temperature (operation)
Service life
Standards/regulations
UL approvals

LI-ION, 120 Wh
2.9 kg / 135 x 202 x 110 mm
IP20 / III
-20 °C ... 60 °C
-
UL/C-UL listed UL 508 , UL/C-UL Recognized UL 60950 , UL ANSI/ISA-12.12.01 Class I, Division 2, Groups A, B, C, D (Hazardous Location)

Ordering data

Description
Energy storage

Type	Order No.	Pcs./Pkt.
UPS-BAT/LI-ION/24DC/120WH	2320351	1

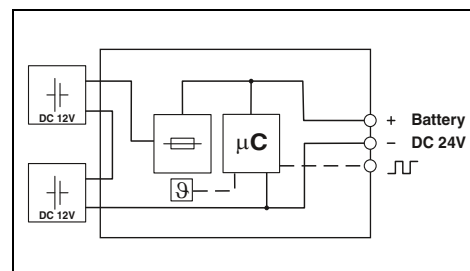

Technical data

24 V
924 Wh
45 A
2x 25 A ATOF 32V (breaking capacity 1000 A)
Yes / No
105 min. (20 A (20 °C)) / 50 min. (40 A (20 °C))

LI-ION, 924 Wh
12.9 kg / 264 x 224 x 197 mm
IP20 / III
-25 °C ... 60 °C
15 years (20 °C)

Ordering data

Type	Order No.	Pcs./Pkt.
UPS-BAT/LI-ION/24DC/924WH	2908232	1

# Power supplies and UPS

## Uninterruptible power supplies

### Energy storage for QUINT UPS

#### UPS BAT/VRLA for maximum buffer times

- Lead AGM (Absorbent Glass Mat) technology
- Ambient temperatures from 0 to +40°C
- Long buffer times for high currents
- Communication with QUINT UPS
- Integrated temperature sensor for optimum charging
- Battery can be changed without tools



VRLA energy storage,  
1.3 Ah

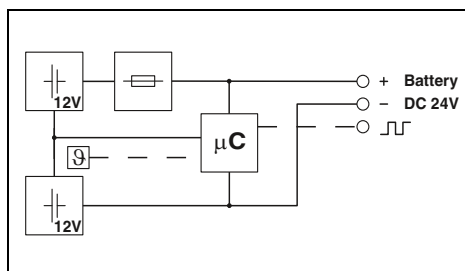

#### Technical data

Input data/output data	
Nominal input voltage	24 V DC
Nominal capacity	1.3 Ah
Output current	15 A
Output fuse	1x 15 A
Can be connected in parallel/series	Yes / No
Buffer period	20 min. (2 A) / 5 min. (5 A)
General data	
Storage medium	Lead rechargeable battery module
Weight / Dimensions W x H x D	1.7 kg / 54 x 157 x 113 mm
Degree of protection / Protection class	IP20 / III
Ambient temperature (operation)	0 °C ... 40 °C
Service life	-
Standards/regulations	
UL approvals	UL/C-UL listed UL 508 , UL/C-UL Recognized UL 60950 , UL ANSI/ISA-12.12.01 Class I, Division 2, Groups A, B, C, D (Hazardous Location)

#### Ordering data

Description	
Energy storage	

Type	Order No.	Pcs./Pkt.
UPS-BAT/VRLA/24DC/1.3AH	2320296	1

#### Accessories

Fuse	
Mounting set	
Mounting set	

FUSE 15A/32V FK1	2908360	2
------------------	---------	---



VRLA energy storage,  
3.4 Ah

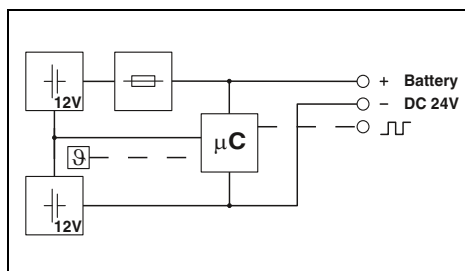

#### Technical data

Input data/output data	
Nominal input voltage	24 V DC
Nominal capacity	3.4 Ah
Output current	25 A
Output fuse	1x 25 A
Can be connected in parallel/series	Yes / No
Buffer period	4.5 min. (20 A) / 3 min. (25 A)
General data	
Storage medium	Lead rechargeable battery module
Weight / Dimensions W x H x D	3.3 kg / 85 x 191 x 110 mm
Degree of protection / Protection class	IP20 / III
Ambient temperature (operation)	0 °C ... 40 °C
Service life	6 years ... 9 years (20 °C)
Standards/regulations	
UL approvals	UL/C-UL listed UL 508 , UL/C-UL Recognized UL 60950 , UL ANSI/ISA-12.12.01 Class I, Division 2, Groups A, B, C, D (Hazardous Location)

#### Ordering data

Type	Order No.	Pcs./Pkt.
UPS-BAT/VRLA/24DC/3.4AH	2320306	1

#### Accessories

FUSE 25A/32V ATOF	2908366	2
-------------------	---------	---



VRLA energy storage,  
7.2 Ah



VRLA energy storage,  
12 Ah



VRLA energy storage,  
38 Ah

UL US ENEC DNV GL  
Ex:

UL US ENEC DNV GL  
Ex:

UL US ENEC DNV GL  
Ex:

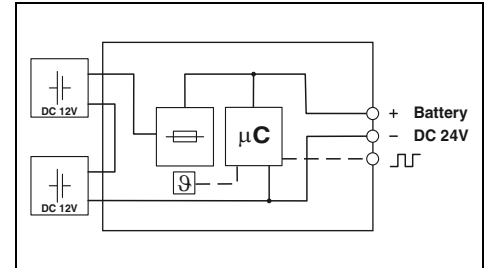
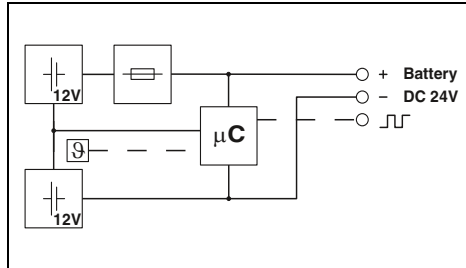
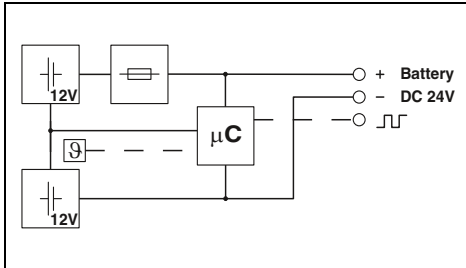

**Technical data**

**Technical data**

**Technical data**

24 V DC  
7.2 Ah  
50 A  
2x 25 A  
Yes / No  
10 min. (20 A) / 3 min. (40 A)

24 V DC  
12 Ah  
50 A  
2x 25 A  
Yes / No  
22.5 min. (20 A) / 9 min. (40 A)

24 V DC  
38 Ah  
45 A  
2x 25 A ATOF 32V  
Yes / No  
72 min. (20 A) / 35 min. (40 A)

Lead rechargeable battery module  
5.9 kg / 135 x 202 x 110 mm  
IP20 / III  
0 °C ... 40 °C  
6 years ... 9 years (20 °C)  
  
UL/C-UL listed UL 508 , UL/C-UL Recognized UL 60950 ,  
UL ANSI/ISA-12.12.01 Class I, Division 2, Groups A, B, C, D  
(Hazardous Location)

Lead rechargeable battery module  
8.9 kg / 202 x 202 x 110 mm  
IP20 / III  
0 °C ... 40 °C  
6 years ... 9 years (20 °C)  
  
UL/C-UL listed UL 508 , UL/C-UL Recognized UL 60950 ,  
UL ANSI/ISA-12.12.01 Class I, Division 2, Groups A, B, C, D  
(Hazardous Location)

Lead rechargeable battery module  
26 kg / 330 x 221 x 197 mm  
IP20 / III  
0 °C ... 40 °C  
-  
  
UL/C-UL listed UL 508 , UL/C-UL Recognized UL 60950 ,  
UL ANSI/ISA-12.12.01 Class I, Division 2, Groups A, B, C, D  
(Hazardous Location)

**Ordering data**

**Ordering data**

**Ordering data**

Type	Order No.	Pcs./Pkt.
UPS-BAT/VRLA/24DC/7.2AH	2320319	1

Type	Order No.	Pcs./Pkt.
UPS-BAT/VRLA/24DC/12AH	2320322	1

Type	Order No.	Pcs./Pkt.
UPS-BAT/VRLA/24DC/38AH	2320335	1

**Accessories**

**Accessories**

**Accessories**

FUSE 25A/32V ATOF	2908366	2
-------------------	---------	---

FUSE 25A/32V ATOF	2908366	2
-------------------	---------	---

FUSE 25A/32V ATOF	2908366	2
BATTERY MOUNTING KIT	2320788	1
BATTERY MOUNTING CASE	2320458	1

# Power supplies and UPS

## Uninterruptible power supplies

### Energy storage for QUINT UPS

#### UPS BAT/VRLA-WTR for temperatures from -25 to +60°C

- Pure lead AGM technology
- Communication with QUINT UPS
- Integrated temperature sensor for optimum charging



Energy storage with wide temperature range  
24 V DC, 13 Ah



Ex:



Energy storage with wide temperature range  
24 V DC, 26 Ah



Ex:

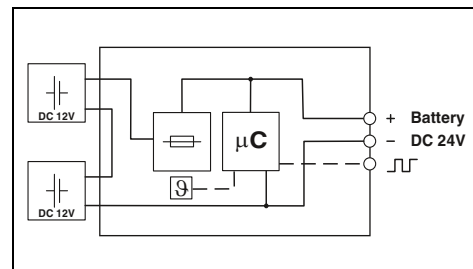
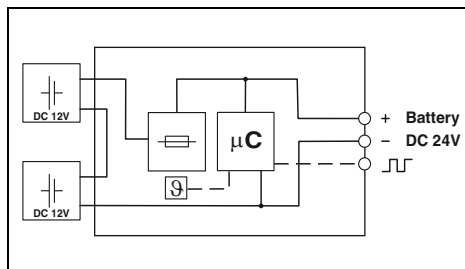

#### Technical data

Input data/output data
Nominal input voltage
Nominal capacity
Output current
Output fuse
Can be connected in parallel/series
Buffer period
General data
Storage medium
Weight / Dimensions W x H x D
Degree of protection / Protection class
Ambient temperature (operation)
Ambient temperature (storage/transport)
Service life
Standards/regulations
UL approvals
GL approvals

24 V DC
13 Ah
45 A
2x 25 A ATOF 32V
Yes / No
50 min. (10 A) / 10 min. (40 A)

Pure lead AGM
10.8 kg / 172 x 177 x 178 mm
IP20 / III
-25 °C ... 60 °C
-40 °C ... 60 °C
-
UL/C-UL listed UL 508 , UL/C-UL Recognized UL 60950
Germanischer Lloyd (EMC 2), ABS, DNV

#### Ordering data

Description
Energy storage

Type	Order No.	Pcs./Pkt.
UPS-BAT/VRLA-WTR/24DC/13AH	2320416	1

#### Accessories

Fuse
Mounting set
Mounting set

FUSE 25A/32V ATOF	2908366	2
BATTERY MOUNTING KIT	2320788	1
BATTERY MOUNTING CASE	2320458	1

#### Technical data

24 V DC
26 Ah
45 A
2x 25 A ATOF 32V
Yes / No
120 min. (10 A) / 30 min. (40 A)
Pure lead AGM
21.6 kg / 358 x 174 x 169 mm
IP20 / III
-25 °C ... 60 °C
-40 °C ... 60 °C
-
UL/C-UL listed UL 508 , UL/C-UL Recognized UL 60950
Germanischer Lloyd (EMC 2), ABS, DNV

#### Ordering data

Type	Order No.	Pcs./Pkt.
UPS-BAT/VRLA-WTR/24DC/26AH	2320429	1

#### Accessories

FUSE 25A/32V ATOF	2908366	2
BATTERY MOUNTING KIT	2320788	1
BATTERY MOUNTING CASE	2320458	1

**Mounting accessories**

**Battery mounting kit**

- For attaching individual battery blocks to a mounting plate
- Consists of four powder-coated metal brackets and a fabric lashing strap



**Battery mounting case**

- Battery frame for universal wall or surface mounting of battery blocks and electronics



 DNV GL

 DNV GL

Description	Ordering data			Ordering data		
	Type	Order No.	Pcs./Pkt.	Type	Order No.	Pcs./Pkt.
Mounting set	BATTERY MOUNTING KIT	2320788	1	BATTERY MOUNTING CASE	2320458	1

# Power supplies and UPS

## Uninterruptible power supplies

### Configuration software for QUINT UPS

The UPS CONF configuration software can be downloaded free of charge from our homepage. Remember to order the IFS-USB-DATACABLE as well in order to use the software.

#### Supported operating systems:

- Windows 8.1 (32 and 64-bit)
- Windows 8.0 (32 and 64-bit)
- Windows 7 (32 and 64-bit)
- Windows 10 (32 and 64-bit)

#### Minimum requirements:

- Display: 800 x 600, 256 colors
- Processor: 400 MHz, Pentium processor or similar
- RAM: 96 MB

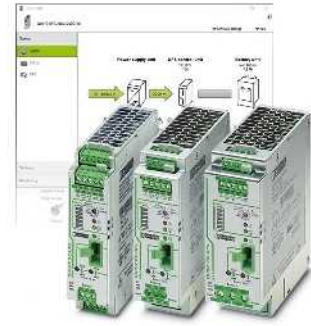

Description	Ordering data		
	Type	Order No.	Pcs./Pkt.
Configuration software for QUINT UPS	UPS-CONF	2320403	1

## Accessories for QUINT UPS and TRIO DC-UPS

### IFS-USB-DATACABLE

- For communication between the uninterruptible power supply and the UPS CONF configuration software

### IFS-CONFSTICK

- For storing the values you have configured and quickly transferring them to other uninterruptible power supplies



Memory module

Description	Ordering data			Ordering data		
	Type	Order No.	Pcs./Pkt.	Type	Order No.	Pcs./Pkt.
<b>Programming adapter</b> for configuring modules with S-PORT interface Cable length: 3 m <b>Multi-functional memory module</b> for the Interface system  - Flat design - Tall design	IFS-USB-DATACABLE	2320500	1	IFS-CONFSTICK	2986122	1
				IFS-CONFSTICK-L	2901103	1

**Accessories for QUINT UPS and TRIO DC-UPS**

**IFS-RS232-DATACABLE**

- For Modbus communication with the RS-232 interface
- Connection to the Phoenix Contact COM server for Ethernet communication
- Communicate directly with higher-level controllers, such as Phoenix Contact ILC or RFC, or use as a gateway



**IFS-MINI-DIN-DATACABLE**

- For direct communication with the ILC from the Phoenix Contact Inline system

**IFS-OPEN-END-DATACABLE**

- Open cable for flexible communication

**QUINT UPS function blocks**

- For further processing of information communicated via data cables
- For PC Worx software
- Free download at phoenixcontact.net/products

Description
<b>Data cable</b> for communication between higher-level controllers and QUINT UPS uninterruptible power supplies, cable length: 2 m
Modbus communication
Direct communication
Flexible communication

Ordering data		
Type	Order No.	Pcs./Pkt.
IFS-RS232-DATACABLE	2320490	1
IFS-MINI-DIN-DATACABLE	2320487	1
IFS-OPEN-END-DATACABLE	2320450	1

**Accessories for QUINT UPS and TRIO DC-UPS**

**IFS-BT-PROG-ADAPTER**

- For wireless communication between the uninterruptible power supply and the UPS CONF configuration software



Bluetooth adapter

Description
<b>Bluetooth programming adapter</b> , with USB and S-PORT interface

Ordering data		
Type	Order No.	Pcs./Pkt.
IFS-BT-PROG-ADAPTER	2905872	1

# Power supplies and UPS

## Uninterruptible power supplies

### Selection of UPS modules with integrated energy storage or integrated power supply



To save space in the control cabinet or to retrofit existing systems easily, UPS versions with integrated energy storage (QUINT, UNO, and STEP) or integrated power supply (MINI and TRIO) are recommended.

### Buffer times for UNO UPS and STEP UPS

Select your UPS solution here.

Example: 2.5 A needs to be buffered for 10 minutes:

Solution:  
STEP-UPS/24DC/24DC/3

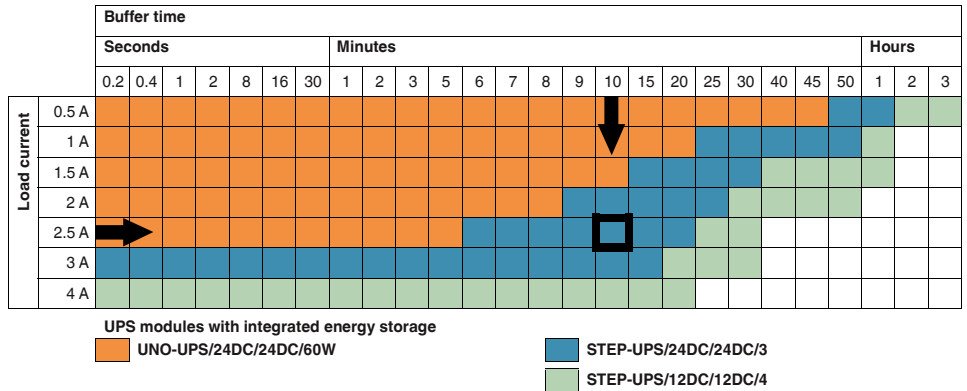

The data is based on an ambient temperature of +20°C.

### Buffer times for QUINT CAP

Select your UPS solution here.

Example: 5 A needs to be buffered for 40 seconds:

Solution:  
QUINT4-CAP/24DC/10/8KJ

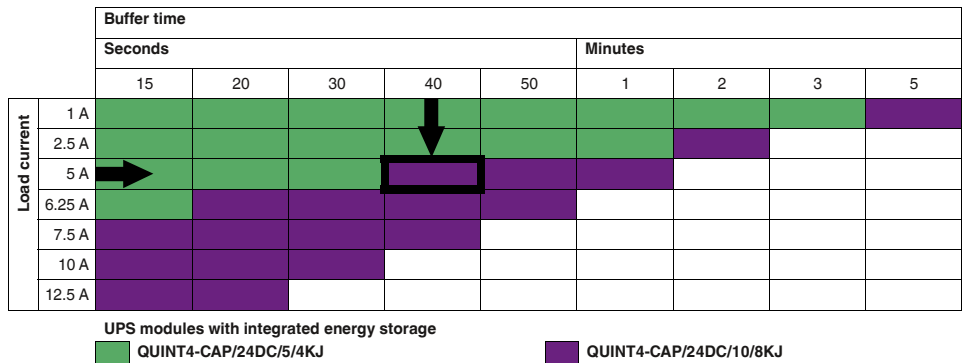

The data is based on an ambient temperature of +25°C.

### Buffer times for QUINT UPS and QUINT BUFFER

Particularly space-saving: UPS module and energy storage combined in one housing. You simply need to connect a power supply upstream.

Select your QUINT UPS or QUINT BUFFER here.

Example: 5 A needs to be buffered for 20 minutes.

Solution:  
QUINT-UPS/24DC/24DC/10/3.4AH

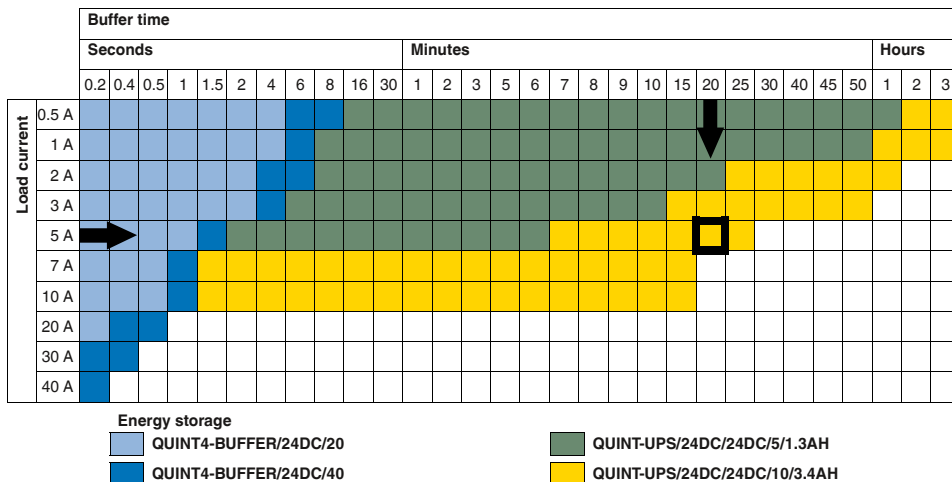

The data is based on an ambient temperature of +20°C.

### Buffer times for MINI UPS and TRIO UPS

Particularly space-saving: UPS module and power supply combined in one housing. You simply need to connect an energy storage device upstream.

#### MINI UPS

Energy storage with lead AGM technology for output voltages of 24 or 12 V DC. Buffer times of up to 50 minutes with 1 A load current.

Note: With the MINI-DC-UPS/12DC/4, buffer times are double those of the MINI-DC-UPS/24DC/2.

#### TRIO UPS

Energy storage with lead AGM technology buffer failures lasting up to 2 hours with 5 A load current.

Select the energy storage for your MINI UPS and TRIO UPS here.

Example: 2 A needs to be buffered for 20 minutes.

Solution:  
MINI-DC-UPS/24DC/2 and  
MINI-BAT/24DC/1.3AH

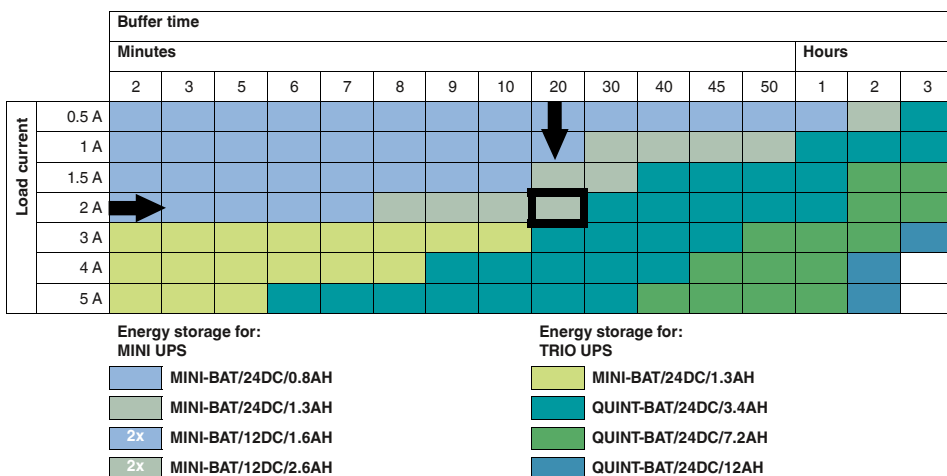

The data is based on an ambient temperature of +20°C.

# Power supplies and UPS

## Uninterruptible power supplies

### UPS module with integrated energy storage

QUINT-UPS is very easy to install in existing systems. You simply need to connect a 24 V DC power supply unit upstream and the reliable UPS solution is complete.

- Advantages of using IQ technology
- Minimal wiring effort
- Maintenance-free energy storage with lead AGM technology

**Notes:**  
The buffer time associated with your solution is dependent on the load current. Exact details for each uninterruptible power supply can be found on page 293.



**Uninterruptible power supply with integrated energy storage, 24 V DC / 24 V DC, 5 A, 1.3 Ah**



**Uninterruptible power supply with integrated energy storage, 24 V DC / 24 V DC, 10 A, 3.4 Ah**

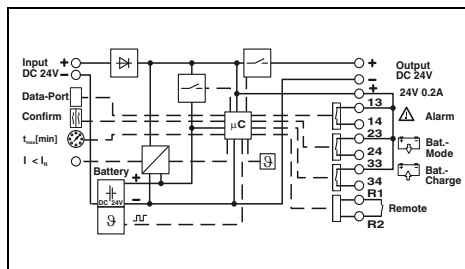

#### Technical data

Input data	18 V DC ... 30 V DC
Input voltage range	9.3 A (24 V DC)
Max. current consumption	Output data
Output data	24 V DC
Nominal output voltage	19.2 V DC ... 27.6 V DC ( $U_{OUT} = U_{BAT} - 0.5 \text{ V DC}$ )
Output voltage range	Output current
Output current	5 A
Can be connected in parallel/series	Yes / No
Buffer period	50 min. (1 A) / 5 min. (5 A)
Max. power dissipation (normal mode / buffer mode)	2.5 W / 3.3 W
Efficiency	> 97.1 % (Mains operation, with charged energy storage)
Signaling	LED, relay contact, interface/software
Signaling	IFS (Interface system data port)
Interfaces	General data
General data	Lead rechargeable battery module 1.3 Ah
Storage medium	2.2 kg / 88 x 138 x 125 mm
Weight / Dimensions W x H x D	horizontal DIN rail NS 35, EN 60715
Mounting position	Can be aligned: horizontal 5 mm, vertical 50 mm
Assembly instructions	Connection method
Connection method	Plug-in screw connection
Input connection data (solid/stranded/AWG)	0.2 - 2.5 mm <sup>2</sup> / 0.2 - 2.5 mm <sup>2</sup> / 20 - 12
Output connection data (solid/stranded/AWG)	0.2 - 2.5 mm <sup>2</sup> / 0.2 - 2.5 mm <sup>2</sup> / 20 - 12
Signal connection data (solid/stranded/AWG)	0.2 - 2.5 mm <sup>2</sup> / 0.2 - 2.5 mm <sup>2</sup> / 24 - 12
Degree of protection / Protection class	IP20 / III
MTBF (IEC 61709, SN 29500)	> 806000 h (40°C)
Ambient temperature (operation)	0 °C ... 40 °C
Ambient temperature (storage/transport)	-15 °C ... 40 °C
Service life	6 years ... 9 years (20 °C)
Latest startup	3 months (0 °C ... 20 °C)
Standards/regulations	1 month (30 °C ... 40 °C)
Electromagnetic compatibility	Conformance with EMC Directive 2014/30/EU
Electrical safety, safety transformer	EN 60950-1/VDE 0805 (SELV)
Electronic equipm. for electrical power installations	EN 50178/VDE 0160 (PELV)
UL approvals	UL/C-UL Recognized UL 60950 , UL Listed UL 508

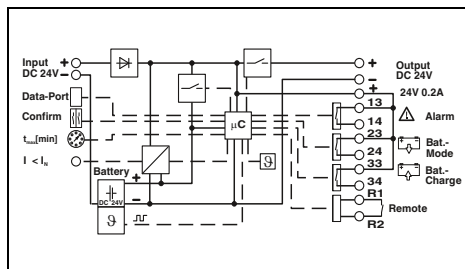

#### Technical data

Input data	18 V DC ... 30 V DC
Input voltage range	18.6 A (24 V DC)
Max. current consumption	Output data
Output data	24 V DC
Nominal output voltage	19.2 V DC ... 27.6 V DC ( $U_{OUT} = U_{BAT} - 0.5 \text{ V DC}$ )
Output voltage range	Output current
Output current	10 A
Can be connected in parallel/series	Yes / No
Buffer period	180 min. (1 A) / 10 min. (10 A)
Max. power dissipation (normal mode / buffer mode)	3.1 W / 6.3 W
Efficiency	> 97.6 % (Mains operation, with charged energy storage)
Signaling	LED, relay contact, interface/software
Signaling	IFS (Interface system data port)
Interfaces	General data
General data	Lead rechargeable battery module, 3.4 Ah
Storage medium	3.8 kg / 120 x 169 x 125 mm
Weight / Dimensions W x H x D	horizontal DIN rail NS 35, EN 60715
Mounting position	Can be aligned: horizontal 5 mm, vertical 50 mm
Assembly instructions	Connection method
Connection method	Plug-in screw connection
Input connection data (solid/stranded/AWG)	0.2 - 2.5 mm <sup>2</sup> / 0.2 - 2.5 mm <sup>2</sup> / 16 - 12
Output connection data (solid/stranded/AWG)	0.2 - 2.5 mm <sup>2</sup> / 0.2 - 2.5 mm <sup>2</sup> / 16 - 12
Signal connection data (solid/stranded/AWG)	0.2 - 2.5 mm <sup>2</sup> / 0.2 - 2.5 mm <sup>2</sup> / 24 - 12
Degree of protection / Protection class	IP20 / III
MTBF (IEC 61709, SN 29500)	> 806000 h (40°C)
Ambient temperature (operation)	0 °C ... 40 °C
Ambient temperature (storage/transport)	-15 °C ... 40 °C
Service life	6 years ... 9 years (20 °C)
Latest startup	6 months (0 °C ... 20 °C)
Standards/regulations	Conformance with EMC Directive 2014/30/EU
Electromagnetic compatibility	EN 60950-1/VDE 0805 (SELV)
Electrical safety, safety transformer	EN 50178/VDE 0160 (PELV)
Electronic equipm. for electrical power installations	UL/C-UL Recognized UL 60950 , UL Listed UL 508

#### Ordering data

Description	Power supply, uninterruptible
-------------	-------------------------------

Type	Order No.	Pcs./Pkt.
QUINT-UPS/ 24DC/ 24DC/ 5/1.3AH	2320254	1

#### Accessories

Fuse	FUSE 15A/32V FKS ATO	2908361	2
------	----------------------	---------	---

#### Ordering data

Type	Order No.	Pcs./Pkt.
QUINT-UPS/ 24DC/ 24DC/10/3.4AH	2320267	1

#### Accessories

Fuse	FUSE 15A/32V FKS ATO	2908361	2
------	----------------------	---------	---

Maintenance-free buffer module

The QUINT BUFFER is ideal for failures lasting just seconds.

It combines an electronic switch-over unit and a capacitor-based energy storage in the same housing.

- Fast tripping of standard miniature circuit breakers with SFB (Selective Fuse Breaking) Technology dynamic power reserve with up to 6 times the nominal current for 12 ms
- Space savings thanks to compact design

**Notes:**  
The buffer time associated with your solution is dependent on the load current. Exact details for each uninterruptible power supply can be found on page 293.



new



new

Maintenance-free capacity module  
24 V DC / 20 A

Maintenance-free capacity module  
24 V DC / 40 A

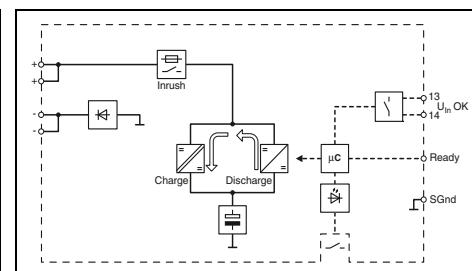
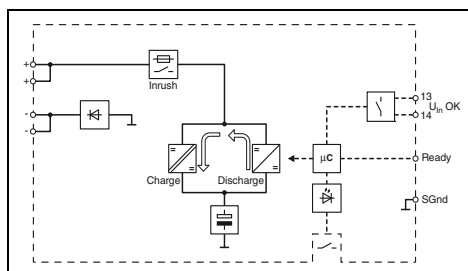

Technical data

Technical data

Input data	
Input voltage range	22.5 V DC ... 30 V DC
Current consumption (idling/charging process/max.)	0.2 A / 0.6 A / 26 A
Connect threshold (fixed, variable)	< 22 V DC , (U <sub>IN</sub> - 1 V)/0.1 s
Output data	
Nominal output voltage	24 V DC
Output current I <sub>N</sub> / I <sub>Stat.Boost</sub> / I <sub>Dyn.Boost</sub> / I <sub>SFB</sub>	20 A / 25 A / 30 A (5 s) / 120 A (15 ms)
Can be connected in parallel/series	No / No
Buffer period	200 ms (20 A)
Maximum power dissipation for nominal condition	< 6 W
Signaling	
LED signaling	U <sub>IN</sub> OK, Ready
Transistor switching output	Ready
Floating signal contact	U <sub>IN</sub> OK
General data	
Storage medium	Electrolytic capacitor
Weight / Dimensions W x H x D	1 kg / 57 x 130 x 125 mm
Mounting position	horizontal DIN rail NS 35, EN 60715
Assembly instructions	Can be aligned: Horizontally 0 mm, vertically 50 mm
Connection method	Screw connection
Input connection data (solid/stranded/AWG)	0.2 - 6 mm <sup>2</sup> / 0.2 - 4 mm <sup>2</sup> / 30 - 10
Output connection data (solid/stranded/AWG)	0.2 - 6 mm <sup>2</sup> / 0.2 - 4 mm <sup>2</sup> / 30 - 10
Signal connection data (solid/stranded/AWG)	0.2 - 1.5 mm <sup>2</sup> / 0.2 - 1.5 mm <sup>2</sup> / 24 - 16
Degree of protection / Protection class	IP20 / II
MTBF (IEC 61709, SN 29500)	> 2497000 h (40°C)
Ambient temperature (operation)	-40 °C ... 70 °C
Standards/regulations	
Insulation voltage: input, output/housing	500 V
Electromagnetic compatibility	Conformance with EMC Directive 2014/30/EU
Electrical safety	IEC 60950-1/VDE 0805 (SELV)
Electronic equipm. for electrical power installations	-
UL approvals	UL Listed UL 508 , UL/C-UL Recognized UL 60950

Input data	
Input voltage range	22.5 V DC ... 30 V DC
Current consumption (idling/charging process/max.)	0.2 A / 0.8 A / 46 A
Connect threshold (fixed, variable)	< 22 V DC , (U <sub>IN</sub> - 1 V)/0.1 s
Output data	
Nominal output voltage	24 V DC
Output current I <sub>N</sub> / I <sub>Stat.Boost</sub> / I <sub>Dyn.Boost</sub> / I <sub>SFB</sub>	40 A / 45 A / 60 A (5 s) / 215 A (15 ms)
Can be connected in parallel/series	No / No
Buffer period	200 ms (40 A)
Maximum power dissipation for nominal condition	< 9 W
Signaling	
LED signaling	U <sub>IN</sub> OK, Ready
Transistor switching output	Ready
Floating signal contact	U <sub>IN</sub> OK
General data	
Storage medium	Electrolytic capacitor
Weight / Dimensions W x H x D	1.2 kg / 73 x 130 x 125 mm
Mounting position	horizontal DIN rail NS 35, EN 60715
Assembly instructions	Can be aligned: Horizontally 0 mm, vertically 50 mm
Connection method	Screw connection
Input connection data (solid/stranded/AWG)	0.5 - 16 mm <sup>2</sup> / 0.5 - 16 mm <sup>2</sup> / 10 - 6
Output connection data (solid/stranded/AWG)	0.5 - 16 mm <sup>2</sup> / 0.5 - 16 mm <sup>2</sup> / 10 - 6
Signal connection data (solid/stranded/AWG)	0.2 - 1.5 mm <sup>2</sup> / 0.2 - 1.5 mm <sup>2</sup> / 24 - 16
Degree of protection / Protection class	IP20 / II
MTBF (IEC 61709, SN 29500)	> 2814000 h (40°C)
Ambient temperature (operation)	-40 °C ... 70 °C
Standards/regulations	
Insulation voltage: input, output/housing	500 V
Electromagnetic compatibility	Conformance with EMC Directive 2014/30/EU
Electrical safety	IEC 60950-1/VDE 0805 (SELV)
Electronic equipm. for electrical power installations	-
UL approvals	UL Listed UL 508 , UL/C-UL Recognized UL 60950

Ordering data

Ordering data

Description	
Buffer module, maintenance-free	

Type	Order No.	Pcs./Pkt.
QUINT4-BUFFER/24DC/20	2907913	1

Type	Order No.	Pcs./Pkt.
QUINT4-BUFFER/24DC/40	2908283	1

# Power supplies and UPS

## Uninterruptible power supplies

### Maintenance-free buffer module

QUINT CAP is ideal for cyclical failures lasting up to 30 seconds. It combines an electronic switch-over unit and a capacitor-based energy storage device in the same housing.

- Convenient PC shutdown
- Maintenance-free with a long service life
- Space savings thanks to compact design
- Long buffer time thanks to high memory capacity

#### Notes:

The buffer time associated with your solution is dependent on the load current. Exact details for each uninterruptible power supply can be found on page 292.



new

**Maintenance-free Ultra-CAP  
Capacity module  
24 V DC, 5 A**

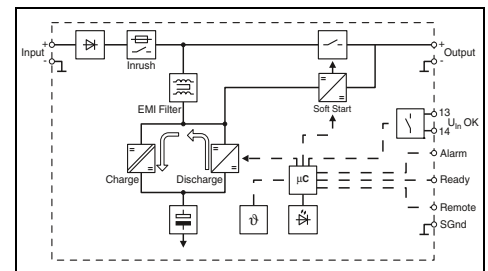

#### Technical data

<b>Input data</b>		
Input voltage range	22.5 V DC ... 30 V DC	
Current consumption (idling/charging process/max.)	0.1 A / 0.8 A / 7 A	
Connect threshold (fixed, variable)	< 22 V DC, -	
<b>Output data</b>		
Nominal output voltage	24 V DC	
Output current $I_N / I_{Stat. Boost} / I_{Dyn. Boost} / I_{SFB}$	5 A / 6.25 A / 10 A (5 s) / 30 A (15 ms)	
Can be connected in parallel/series	Yes / No	
Buffer period	3 min. (1 A) / 1 min. (2.5 A) / 30 s (5 A)	
Maximum power dissipation for nominal condition	< 3 W	
<b>Signaling</b>		
LED signaling	U <sub>IN</sub> OK, Alarm, Ready	
Transistor switching output	Alarm, Ready	
Floating signal contact	U <sub>IN</sub> OK	
<b>General data</b>		
Storage medium	Double-layer capacitor	
Weight / Dimensions W x H x D	1.3 kg / 94 x 130 x 125 mm	
Mounting position	horizontal DIN rail NS 35, EN 60715	
Assembly instructions	Can be aligned: Horizontally 0 mm, vertically 50 mm	
Connection method	Screw connection	
Input connection data (solid/stranded/AWG)	0.2 - 2.5 mm <sup>2</sup> / 0.2 - 2.5 mm <sup>2</sup> / 30 - 12	
Output connection data (solid/stranded/AWG)	0.2 - 2.5 mm <sup>2</sup> / 0.2 - 2.5 mm <sup>2</sup> / 30 - 12	
Signal connection data (solid/stranded/AWG)	0.2 - 1.5 mm <sup>2</sup> / 0.2 - 1.5 mm <sup>2</sup> / 24 - 16	
Degree of protection / Protection class	IP20 / II	
MTBF (IEC 61709, SN 29500)	> 1302000 h (40°C)	
Ambient temperature (operation)	-40 °C ... 60 °C	
<b>Standards/regulations</b>		
Insulation voltage: input, output/housing	500 V	
Electromagnetic compatibility	Conformance with EMC Directive 2014/30/EU	
Electrical safety	IEC 60950-1/VDE 0805 (SELV)	
Electronic equipm. for electrical power installations	-	
UL approvals	UL Listed UL 508, UL/C-UL Recognized UL 60950	
<b>Ordering data</b>		
<b>Type</b>	<b>Order No.</b>	<b>Pcs./Pkt.</b>
QUINT4-CAP/24DC/5/4KJ	2320539	1

<b>Description</b>
Buffer module, maintenance-free



new



**Maintenance-free Ultra-CAP  
Capacity module  
24 V DC, 10 A**

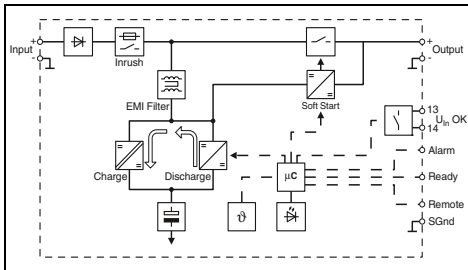

**Technical data**

22.5 V DC ... 30 V DC  
0.1 A / 1 A / 13.5 A  
< 22 V DC, -

24 V DC  
10 A / 12.5 A / 20 A (5 s) / 60 A (15 ms)  
Yes / No  
5 min. (1 A) / 1 min. (5 A) / 30 s (10 A)  
< 6 W

U<sub>N</sub> OK, Alarm, Ready  
Alarm, Ready  
U<sub>N</sub>OK

Double-layer capacitor  
1.6 kg / 118 x 130 x 125 mm  
horizontal DIN rail NS 35, EN 60715  
Can be aligned: Horizontally 0 mm, vertically 50 mm  
Screw connection  
0.2 - 2.5 mm<sup>2</sup> / 0.2 - 2.5 mm<sup>2</sup> / 30 - 12  
0.2 - 2.5 mm<sup>2</sup> / 0.2 - 2.5 mm<sup>2</sup> / 30 - 12  
0.2 - 1.5 mm<sup>2</sup> / 0.2 - 1.5 mm<sup>2</sup> / 24 - 16  
IP20 / II  
> 1387000 h (40°C)  
-40 °C ... 60 °C

500 V  
Conformance with EMC Directive 2014/30/EU  
IEC 60950-1/VDE 0805 (SELV)  
-  
UL Listed UL 508, UL/C-UL Recognized UL 60950

**Ordering data**

Type	Order No.	Pcs./Pkt.
QUINT4-CAP/24DC/10/8KJ	2320571	1

# Power supplies and UPS

## Uninterruptible power supplies

### UPS module with integrated energy storage

#### STEP UPS

The STEP BAT energy storage is included when ordering the STEP UPS. The STEP BAT can be reordered separately. (See accessories on this page)

**Notes:**  
 With the STEP-UPS/12DC/12DC/4, buffer times are double those of the STEP-UPS/24DC/24 DC/3. See page 292.  
 The buffer time associated with your solution is dependent on the load current. Exact details for each uninterruptible power supply can be found on page 292.



**Uninterruptible power supply with integrated rechargeable battery, 24 V DC / 24 V DC, 3 A**

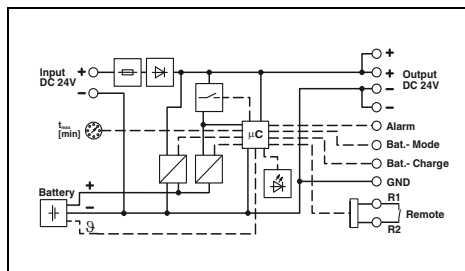

#### Technical data

Input data	
Nominal input voltage range	24 V DC
Input voltage range	22.5 V DC ... 29.5 V DC
Max. current consumption	4.7 A
Current consumption charging process	0.5 A
Input fuse	7 A (slow-blow, internal)
Output data	
Nominal output voltage	24 V DC
Output current standard operation	3 A
Output current Power Boost	4 A (0 °C ... 35 °C)
Can be connected in parallel/series	No / No
Buffer period	50 min. (1 A) / 25 min. (2 A) / 17 min. (3 A)
Max. power dissipation (normal mode / buffer mode)	2 W / 3.8 W
Efficiency	> 98 % (Mains operation, with charged energy storage) / > 95 % (Battery operation)
Signaling	
Signaling Power OK	LED
Signaling alarm	LED, active transistor switching output
Signaling battery charge	LED, active transistor switching output
Signaling battery mode	LED, active transistor switching output
General data	
Storage medium	Lithium polymer
Weight / Dimensions W x H x D	0.45 kg / 108 x 90 x 61 mm
Mounting position	horizontal DIN rail NS 35, EN 60715
Assembly instructions	Can be aligned: Horizontally 0 mm, vertically 50 mm
Connection method	Screw connection
Input connection data (solid/stranded/AWG)	0.2 - 2.5 mm <sup>2</sup> / 0.2 - 2.5 mm <sup>2</sup> / 24 - 12
Output connection data (solid/stranded/AWG)	0.2 - 2.5 mm <sup>2</sup> / 0.2 - 2.5 mm <sup>2</sup> / 24 - 12
Signal connection data (solid/stranded/AWG)	0.2 - 2.5 mm <sup>2</sup> / 0.2 - 2.5 mm <sup>2</sup> / 24 - 12
Degree of protection / Protection class	IP20 / III
MTBF (IEC 61709, SN 29500)	> 1401000 h (40°C)
Ambient temperature (operation)	0 °C ... 40 °C
Standards/regulations	
Electromagnetic compatibility	Conformance with EMC Directive 2014/30/EU
Electrical safety, safety transformer	EN 60950-1/VDE 0805 (SELV)
Electronic equipm. for electrical power installations	EN 50178/VDE 0160 (PELV)
UL approvals	UL Listed UL 508, UL/C-UL Recognized UL 60950

#### Ordering data

Description	Type	Order No.	Pcs./Pkt.
Power supply, uninterruptible	STEP-UPS/24DC/24DC/3	2868703	1

#### Accessories

Energy storage	STEP-BAT/LIPO/18.5DC/1.4AH	2320364	1
----------------	----------------------------	---------	---



**Uninterruptible power supply with integrated battery module, 12 V DC / 12 V DC, 4 A**

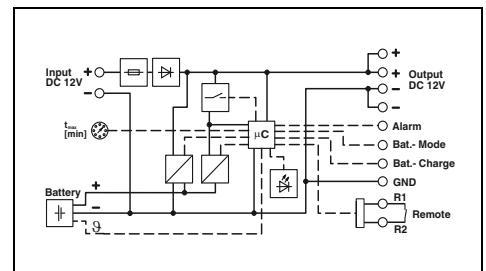

#### Technical data

Input data	
Nominal input voltage range	12 V DC
Input voltage range	10 V DC ... 16.5 V DC
Max. current consumption	6 A
Current consumption charging process	0.8 A
Input fuse	7 A (slow-blow, internal)
Output data	
Nominal output voltage	12 V DC
Output current standard operation	4 A
Output current Power Boost	5 A (0 °C ... 35 °C)
Can be connected in parallel/series	No / No
Buffer period	100 min. (1 A) / 50 min. (2 A) / 30 min. (3 A)
Max. power dissipation (normal mode / buffer mode)	1.2 W / 4.4 W
Efficiency	> 97.4 % (Mains operation, with charged energy storage) / > 92 % (Battery operation)
Signaling	
Signaling Power OK	LED
Signaling alarm	LED, active transistor switching output
Signaling battery charge	LED, active transistor switching output
Signaling battery mode	LED, active transistor switching output
General data	
Storage medium	Lithium polymer
Weight / Dimensions W x H x D	0.46 kg / 108 x 90 x 61 mm
Mounting position	horizontal DIN rail NS 35, EN 60715
Assembly instructions	Can be aligned: Horizontally 0 mm, vertically 50 mm
Connection method	Screw connection
Input connection data (solid/stranded/AWG)	0.2 - 2.5 mm <sup>2</sup> / 0.2 - 2.5 mm <sup>2</sup> / 24 - 12
Output connection data (solid/stranded/AWG)	0.2 - 2.5 mm <sup>2</sup> / 0.2 - 2.5 mm <sup>2</sup> / 24 - 12
Signal connection data (solid/stranded/AWG)	0.2 - 2.5 mm <sup>2</sup> / 0.2 - 2.5 mm <sup>2</sup> / 24 - 12
Degree of protection / Protection class	IP20 / III
MTBF (IEC 61709, SN 29500)	> 1997000 h (40°C)
Ambient temperature (operation)	0 °C ... 40 °C
Standards/regulations	
Electromagnetic compatibility	Conformance with EMC Directive 2014/30/EU
Electrical safety, safety transformer	EN 60950-1/VDE 0805 (SELV)
Electronic equipm. for electrical power installations	EN 50178/VDE 0160 (PELV)
UL approvals	UL Listed UL 508, UL/C-UL Recognized UL 60950

#### Ordering data

Description	Type	Order No.	Pcs./Pkt.
Power supply, uninterruptible	STEP-UPS/12DC/12DC/4	2868693	1

#### Accessories

Energy storage	STEP-BAT/LIPO/18.5DC/1.4AH	2320364	1
----------------	----------------------------	---------	---

**UPS module with integrated energy storage**

**UNO UPS**

The energy storage is included when ordering the UNO UPS.

**Notes:**  
The buffer time associated with your solution is dependent on the load current. Exact details for each uninterruptible power supply can be found on page 292.



**Uninterruptible power supply with integrated rechargeable battery, 24 V DC/24 V DC, 60 W**

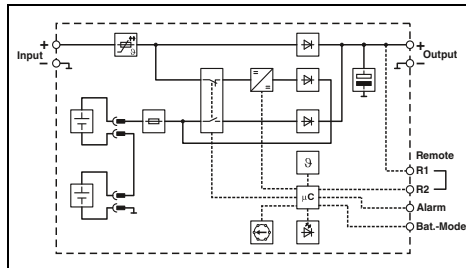

**Technical data**

<b>Input data</b>	
Nominal input voltage range	24 V DC
Input voltage range	22.5 V DC ... 29.5 V DC
Max. current consumption	2.8 A
Current consumption charging process	-
Input fuse	5 A (electronic)
<b>Output data</b>	
Nominal output voltage	24 V DC (SELV)
Output current standard operation	2.5 A
Output current Power Boost	-
Can be connected in parallel/series	yes, with redundancy module / No
Buffer period	45 min. (0.5 A) / 20 min. (1 A) / 8 min. (2 A)
Max. power dissipation (normal mode / buffer mode)	3 W / -
Efficiency	> 95 % (Mains operation, with charged energy storage) / > 92 % (Battery operation)
<b>Signaling</b>	
Signaling Power OK	LED
Signaling alarm	LED, active transistor switching output
Signaling battery charge	-
Signaling battery mode	LED, active transistor switching output
<b>General data</b>	
Storage medium	Lead rechargeable battery module
Weight / Dimensions W x H x D	1 kg / 110 x 90 x 84 mm
Mounting position	horizontal DIN rail NS 35, EN 60715
Assembly instructions	Alignable: 0 mm horizontally, 30 mm vertically
Connection method	Screw connection
Input connection data (solid/stranded/AWG)	0.2 - 2.5 mm <sup>2</sup> / 0.2 - 2.5 mm <sup>2</sup> / 24 - 14
Output connection data (solid/stranded/AWG)	0.2 - 2.5 mm <sup>2</sup> / 0.2 - 2.5 mm <sup>2</sup> / 24 - 14
Signal connection data (solid/stranded/AWG)	0.2 - 2.5 mm <sup>2</sup> / 0.2 - 2.5 mm <sup>2</sup> / 24 - 14
Degree of protection / Protection class	IP20 / III
MTBF (IEC 61709, SN 29500)	> 1900000 h (40°C)
Ambient temperature (operation)	-15 °C ... 50 °C
<b>Standards/regulations</b>	
Electromagnetic compatibility	Conformance with EMC Directive 2014/30/EU
Electrical safety, safety transformer	EN 60950-1/VDE 0805 (SELV)
Electronic equipm. for electrical power installations	EN 50178/VDE 0160 (PELV)
UL approvals	UL Listed UL 508 , UL/C-UL Recognized UL 60950

**Ordering data**

Description	Type	Order No.	Pcs./Pkt.
Power supply, uninterruptible	UNO-UPS/24DC/24DC/60W	2905907	1

**Accessories**

Fuse			
FUSE 5A/32V FK-1		2908367	2

# Power supplies and UPS

## Uninterruptible power supplies

### UPS module with integrated power supply

#### TRIO UPS

Developed specifically for supplying industrial PCs. Configuration port: freely parameterizable with the UPS CONF configuration software. Configuration stick: parameterize stick once and transfer to any number of TRIO UPS units.

The UPS-CONF (Order No. [2320403](#)) configuration software can be downloaded free of charge from our homepage.



UPS with integrated power supply,  
100 - 240 V AC / 24 V DC, 5 A

**Notes:**  
The buffer time associated with your solution is dependent on the load current. Exact details for each uninterruptible power supply can be found on page 293.

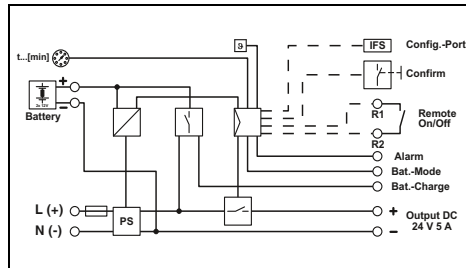

#### Technical data

Input data	100 V AC ... 240 V AC 85 V AC ... 264 V AC / 100 V DC ... 350 V DC 0.95 A (230 V AC) / 1.1 A (230 V AC, maximum) , 1.7 A (120 V AC) / 1.8 A (120 V AC, maximum) 6.3 A (slow-blow, internal) B6 , B10 , B16
Output data	24 V DC 5 A No / No 20 min. (5 A) 16 W / 4 W
Efficiency	> 88 % (230 V AC, mains operation) / > 86 % (120 V AC, mains operation) / > 86 % (Battery operation)
Signaling	IFS (Interface system data port) LED LED, active switching output LED, active switching output LED, active switching output
General data	External, battery 1.3 Ah / 3.4 Ah / 7.2 Ah / 12 Ah 1.1 kg / 60 x 130 x 118 mm horizontal DIN rail NS 35, EN 60715 Can be aligned: Horizontally 0 mm, vertically 50 mm Screw connection 0.2 - 2.5 mm <sup>2</sup> / 0.2 - 2.5 mm <sup>2</sup> / 24 - 12 0.2 - 2.5 mm <sup>2</sup> / 0.2 - 2.5 mm <sup>2</sup> / 24 - 12 0.2 - 2.5 mm <sup>2</sup> / 0.2 - 2.5 mm <sup>2</sup> / 24 - 12 IP20 / I > 596000 h (40°C) -25 °C ... 70 °C (> 55 °C derating: 2.5%/K)
Standards/regulations	2 kV (routine test) / 4 kV (type test) Conformance with EMC Directive 2014/30/EU EN 60950-1/VDE 0805 (SELV) EN 50178/VDE 0160 (PELV) UL/C-UL listed UL 508 , UL/C-UL Recognized UL 60950

#### Ordering data

Description	Type	Order No.	Pcs./Pkt.
Power supply, uninterruptible	TRIO-UPS/1AC/24DC/ 5	<a href="#">2866611</a>	1

**UPS module with integrated power supply**

**MINI-UPS 24 V DC and 12 V DC**

The MINI UPS combines the power supply and the UPS module in the same housing in a particularly space-saving way.

**Notes:**  
 With the MINI-DC-UPS/12DC/4, buffer times are double those of the MINI-DC-UPS/24DC/2.  
 The buffer time associated with your solution is dependent on the load current. Exact details for each uninterruptible power supply can be found on page 293.

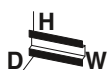

**UPS with integrated power supply,  
100 - 240 V AC / 24 V DC, 2 A**



**UPS with integrated power supply,  
100 - 240 V AC / 12 V DC, 4 A**

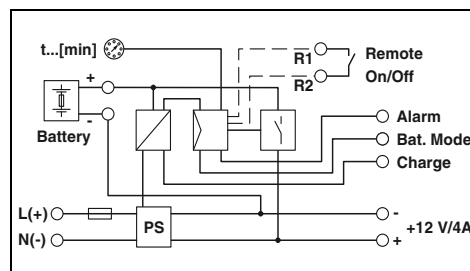
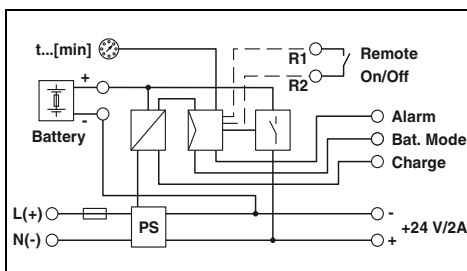

<b>Input data</b>	
Nominal input voltage range	100 V AC ... 240 V AC
Input voltage range	85 V AC ... 264 V AC / 100 V DC ... 350 V DC
Max. current consumption in normal mode	0.6 A / 0.85 A (230 V AC) , 1.1 A / 1.5 A (120 V AC)
<b>Input fuse</b>	3.15 A (slow-blow, internal)
Reliable backup fuse, circuit breaker	B6 , B10 , B16
<b>Output data</b>	
Nominal output voltage	24 V DC (AC input voltage available: 22.5 to 29.5 V DC, AC input voltage not available: 27.9 to 19.2 V DC)
<b>Output current</b>	2 A
Can be connected in parallel/series	No / yes
Buffer period	20 min. (2 A)
Max. power dissipation (idling / normal mode / buffer mode)	3.8 W / 10.1 W / 2.1 W
<b>Efficiency</b>	> 83 %
<b>Signaling</b>	
Signaling Power OK	LED
Signaling alarm	LED, active switching output
Signaling battery charge	LED, active switching output
Signaling battery mode	LED, active switching output
<b>General data</b>	
Storage medium	External, battery 0.8 Ah / 1.3 Ah
Weight / Dimensions W x H x D	0.45 kg / 67.5 x 99 x 107 mm
Mounting position	horizontal DIN rail NS 35, EN 60715
Assembly instructions	Can be aligned: Horizontally 0 mm, vertically 50 mm
Connection method	COMBICON plug-in screw connections
Input connection data (solid/stranded/AWG)	0.2 - 2.5 mm <sup>2</sup> / 0.2 - 2.5 mm <sup>2</sup> / 24 - 12
Output connection data (solid/stranded/AWG)	0.2 - 2.5 mm <sup>2</sup> / 0.2 - 2.5 mm <sup>2</sup> / 24 - 12
Signal connection data (solid/stranded/AWG)	0.2 - 2.5 mm <sup>2</sup> / 0.2 - 2.5 mm <sup>2</sup> / 24 - 12
Degree of protection / Protection class	IP20 / II
MTBF (IEC 61709, SN 29500)	> 753000 h (40°C)
Ambient temperature (operation)	-25 °C ... 70 °C (> 60 °C derating: 2.5%/K)
<b>Standards/regulations</b>	
Insulation voltage input/output	2 kV (routine test) / 4 kV (type test)
Electromagnetic compatibility	Conformance with EMC Directive 2014/30/EU
Electrical safety, safety transformer	EN 60950-1/VDE 0805 (SELV)
Electronic equipm. for electrical power installations	EN 50178/VDE 0160 (PELV)
UL approvals	UL Listed UL 508 , UL/C-UL Recognized UL 60950 , UL ANSI/ISA-12.12.01 Class I, Division 2, Groups A, B, C, D (Hazardous Location)

**Technical data**

**Technical data**

<b>Description</b>	<b>Power supply, uninterruptible</b>
--------------------	--------------------------------------

**Ordering data**

Type	Order No.	Pcs./Pkt.
MINI-DC-UPS/24DC/2	2866640	1

**Ordering data**

Type	Order No.	Pcs./Pkt.
MINI-DC-UPS/12DC/4	2866598	1

# Power supplies and UPS

## Uninterruptible power supplies

### Energy storage for TRIO UPS

#### MINI-BAT, QUINT-BAT

MINI-BAT and QUINT BAT for maximum buffer times

- Lead AGM (Absorbent Glass Mat) technology
- Ambient temperatures from 0 to +40°C



Energy storage, 24 V DC, 1.3 Ah for TRIO UPS and MINI UPS 2 A

ERC  
Ex:

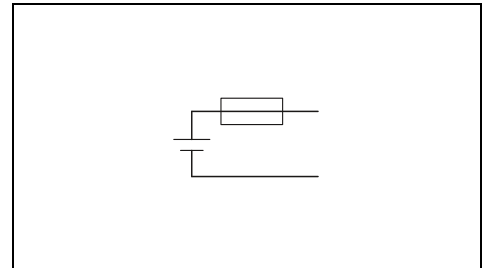

Input data/output data	
Nominal capacity	1.3 Ah
Nominal output voltage	24 V DC
Output current	15 A
Can be connected in parallel/series	Yes / No
General data	
Weight / Dimensions W x H x D	1.7 kg / 52 x 130 x 110 mm
Degree of protection / Protection class	IP20 / III
Ambient temperature (operation)	0 °C ... 40 °C
Service life	6 years ... 9 years (20 °C)
Latest startup	6 months (20 °C ... 30 °C) 3 months (30 °C ... 40 °C)

#### Technical data

Nominal capacity	1.3 Ah
Nominal output voltage	24 V DC
Output current	15 A
Can be connected in parallel/series	Yes / No
General data	
Weight / Dimensions W x H x D	1.7 kg / 52 x 130 x 110 mm
Degree of protection / Protection class	IP20 / III
Ambient temperature (operation)	0 °C ... 40 °C
Service life	6 years ... 9 years (20 °C)
Latest startup	6 months (20 °C ... 30 °C) 3 months (30 °C ... 40 °C)

Description
<b>Energy storage</b>

#### Ordering data

Type	Order No.	Pcs./Pkt.
MINI-BAT/24DC/1.3AH	2866417	1

Fuse
------

#### Accessories

FUSE 15A/32V FKS ATO	2908361	2
----------------------	---------	---



Energy storage, 24 V DC, 3.4 Ah for TRIO UPS



Energy storage, 24 V DC, 7.2 Ah for TRIO UPS



Energy storage, 24 V DC, 12 Ah for TRIO UPS

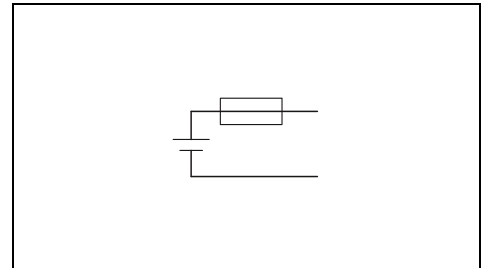
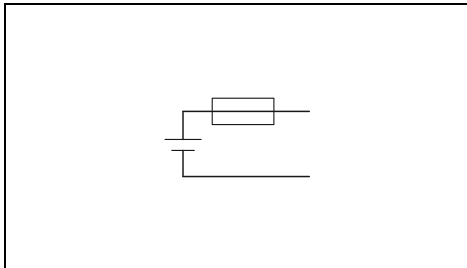
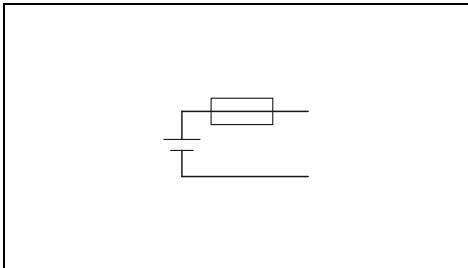

Technical data

Technical data

Technical data

3.4 Ah  
24 V DC  
25 A  
Yes / No

7.2 Ah  
24 V DC  
50 A  
Yes / No

12 Ah  
24 V DC  
50 A  
Yes / No

3.5 kg / 112 x 145 x 123 mm  
IP20 / -  
0 °C ... 40 °C  
6 years ... 9 years (20 °C)  
9 months (20 °C ... 30 °C)  
6 months (30 °C ... 40 °C)

6 kg / 164 x 156 x 110 mm  
IP20 / III  
0 °C ... 40 °C  
6 years ... 9 years (20 °C)  
9 months (20 °C ... 30 °C)  
6 months (30 °C ... 40 °C)

9 kg / 231 x 156 x 110 mm  
IP20 / III  
0 °C ... 40 °C  
6 years ... 9 years (20 °C)  
9 months (20 °C ... 30 °C)  
6 months (30 °C ... 40 °C)

Ordering data

Ordering data

Ordering data

Type	Order No.	Pcs./Pkt.
QUINT-BAT/24DC/ 3.4AH	2866349	1

Type	Order No.	Pcs./Pkt.
QUINT-BAT/24DC/ 7.2AH	2866352	1

Type	Order No.	Pcs./Pkt.
QUINT-BAT/24DC/12AH	2866365	1

Accessories

Accessories

Accessories

FUSE 25A/32V ATOF	2908366	2
-------------------	---------	---

FUSE 25A/32V ATOF	2908366	2
-------------------	---------	---

FUSE 25A/32V ATOF	2908366	2
-------------------	---------	---

# Power supplies and UPS

## Uninterruptible power supplies

### Energy storage for MINI UPS

#### MINI-BAT

- MINI-BAT for maximum buffer times
- Lead AGM (Absorbent Glass Mat) technology
- Ambient temperatures from 0 to +40°C

#### Notes:

The buffer time associated with your solution is dependent on the load current. Exact details for each uninterruptible power supply can be found on page 293.



Energy storage, 24 V DC, 0.8 Ah for MINI UPS 2 A

ERC  
Ex:

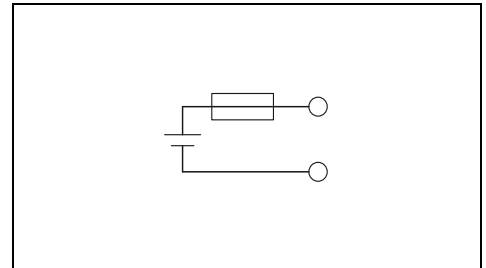

Input data/output data	
Nominal capacity	0.8 Ah
Nominal output voltage	24 V DC
Output current	5 A
Can be connected in parallel/series	Yes / No
General data	
Weight / Dimensions W x H x D	0.9 kg / 67.5 x 99 x 107 mm
Degree of protection / Protection class	IP20 / III
Ambient temperature (operation)	0 °C ... 40 °C
Service life	4 years (20 °C)
Latest startup	6 months (20 °C ... 30 °C) 3 months (30 °C ... 40 °C)

#### Technical data

Nominal capacity	0.8 Ah
Nominal output voltage	24 V DC
Output current	5 A
Can be connected in parallel/series	Yes / No
General data	
Weight / Dimensions W x H x D	0.9 kg / 67.5 x 99 x 107 mm
Degree of protection / Protection class	IP20 / III
Ambient temperature (operation)	0 °C ... 40 °C
Service life	4 years (20 °C)
Latest startup	6 months (20 °C ... 30 °C) 3 months (30 °C ... 40 °C)

Description
<b>Energy storage</b>

Ordering data		
Type	Order No.	Pcs./Pkt.
MINI-BAT/24DC/0.8AH	2866666	1

Fuse
------

Accessories		
FUSE	Order No.	Pcs./Pkt.
FUSE 5A/32V FK-1	2908367	2



Energy storage, 24 V DC, 1.3 Ah  
for TRIO UPS and MINI UPS 2 A



Energy storage 12 V DC, 1.6 Ah  
for MINI UPS 4 A



Energy storage 12 V DC, 2.6 Ah  
for MINI UPS 4 A

ERC  
Ex:

ERC  
Ex:

ERC  
Ex:

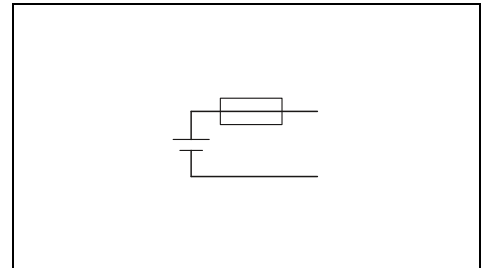
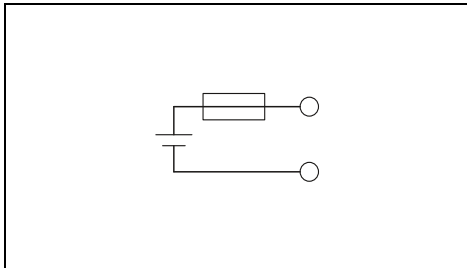
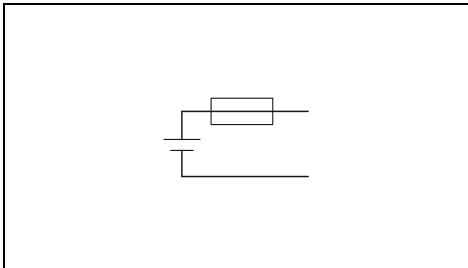

Technical data

Technical data

Technical data

1.3 Ah  
24 V DC  
15 A  
Yes / No

1.6 Ah  
12 V DC  
10 A  
Yes / No

2.6 Ah  
12 V DC  
15 A  
Yes / No

1.7 kg / 52 x 130 x 110 mm  
IP20 / III  
0 °C ... 40 °C  
6 years ... 9 years (20 °C)  
6 months (20 °C ... 30 °C)  
3 months (30 °C ... 40 °C)

0.9 kg / 67.5 x 99 x 107 mm  
IP20 / III  
0 °C ... 40 °C  
4 years (20 °C)  
6 months (20 °C ... 30 °C)  
3 months (30 °C ... 40 °C)

1.7 kg / 52 x 130 x 110 mm  
IP20 / III  
0 °C ... 40 °C  
6 years ... 9 years (20 °C)  
6 months (20 °C ... 30 °C)  
3 months (30 °C ... 40 °C)

Ordering data

Ordering data

Ordering data

Type	Order No.	Pcs./Pkt.
MINI-BAT/24DC/1.3AH	2866417	1

Type	Order No.	Pcs./Pkt.
MINI-BAT/12DC/1.6AH	2866572	1

Type	Order No.	Pcs./Pkt.
MINI-BAT/12DC/2.6AH	2866569	1

Accessories

Accessories

Accessories

FUSE 15A/32V FKS ATO	2908361	2
----------------------	---------	---

FUSE 10A/32V FK1	2908364	2
------------------	---------	---

FUSE 25A/32V FKS	2908363	2
------------------	---------	---



# Device circuit breakers

## High-quality device circuit breakers provide optimum system protection

Thermomagnetic and electronic device circuit breakers are a key factor in maximizing system availability. In the event of overload and short-circuit currents, they selectively shut down the faulty circuit.

 Your web code: [#0156](#)

<b>Basics</b>	<b>308</b>
<hr/>	
<b>Multi-channel device circuit breakers</b>	<b>310</b>
Selection guide	312
Applications	313
CBM electronic circuit breakers	314
CBMC electronic circuit breakers	316
<hr/>	
<b>Single-channel device circuit breakers</b>	<b>318</b>
Selection guide	320
Applications	321
Electronic circuit breakers	322
Thermomagnetic circuit breakers	328
Thermal circuit breakers	334



### Why device circuit breakers?

Overload currents and short-circuit currents are usually unexpected. They cause malfunctions and interruptions to the ongoing operation of a system. Production downtimes and repair costs can often be the unfortunate consequences.

Minimize damage by protecting individual devices or device groups separately. In this way, terminal devices are optimally protected against damage or destruction. System parts which are not in the affected circuit continue to operate without interruption, insofar as the overall process allows.

### Overload currents

Overload currents occur if terminal devices unexpectedly require a higher current than the rated current provided. Such situations may arise, for example, due to a blocked drive. Temporary starting currents from machines are also considered to be overload currents. The occurrence of these can essentially be calculated, but nonetheless can vary depending upon the machine load at the moment it starts.

When selecting suitable fuses or circuit breakers for such circuits, these conditions should be taken into account. Safe shutdown should occur in the seconds to minute range.

### Short-circuit currents

Short circuits may occur in the case of damage to the insulation between conductors, which carry operating voltage. Typical protective devices for shutting down short-circuit currents include fuses or miniature circuit breakers with various tripping mechanisms.

Short-circuit currents should be reliably shut down in the milliseconds range.

### Selecting the right device circuit breakers

The demands placed on optimum device protection vary depending on the area of application. Device circuit breakers therefore work with a wide range of technologies: electronic, thermal, and thermomagnetic. The differences are in the tripping technology and shutdown behavior used. Characteristic curves clearly illustrate the switch-off characteristics of the various device circuit breakers.

Device circuit breakers are selected based on the nominal voltage, nominal current, and, if required, the starting current of a terminal device. The expected error situation (short circuit or overload) then determines the appropriate shutdown behavior.

**i** Your web code: #1253



### The right protection for a circuit

The right choice of protective device ensures safe operation of electrical systems and high system availability.

Circuit breakers protect current distribution cables in buildings or systems. It is only in the event of a short circuit in a terminal device that they switch off to protect the power supply line in the event of overload. The circuit breakers have a high switching capacity of upwards of 6 kA.

As the last protection stage for terminal devices, thermomagnetic and electronic circuit breakers offer the most effective short-circuit and overload protection. If individual loads or small function groups are protected individually, then unaffected system parts can continue to work in the event of an error, insofar as the overall process allows.

If a new circuit is installed, appropriate protection for the terminal device provided must be sought immediately. During installation, cable lengths and conductor cross sections must also be observed. The cables must be designed for the expected operating current, but should also be able to deal with any potential overload and short-circuit currents. Within the scope of graded protection of system areas, the selectivity between the individual fuses or protective devices must be retained. This ensures higher system availability as only the faulty circuit is switched off.

It is advisable to make device circuit breakers easily accessible when installed in control cabinets so that they can be switched on again quickly and without problems after tripping. In addition, a control cabinet should not contain too many components, as this can cause an overload in the power supply. Furthermore, a sufficient air flow and cooling process should be ensured. This enables incorrect tripping to be prevented.

### Influence of cable lengths on shutdown behavior

In the event of an error, long cable paths limit the required tripping current. They can delay or even prevent shutdown.

The maximum cable lengths that can be used between a power supply and a terminal device are defined by the following criteria:

- The maximum current of the power supply
- The internal resistance of the circuit breaker
- The cable resistance

The cable resistance is dependent on the cable length and conductor cross section. For this reason, as a general rule, the shortest cable path should be selected during installation.

The length and cross section determine the switch-off conditions for a device circuit breaker.

Cable resistance counteracts a short-circuit current. In the event of low voltage sources, a short-circuit current can be limited by the cable resistance in such a way that safety equipment no longer recognizes this current as a short-circuit current. In the case of circuit breakers with C characteristics, for example, the upper tripping limit is significantly higher than the nominal current. For this reason, a delayed shutdown is highly likely in the event of a short circuit when using this safety equipment.

Optimized protective devices with SFB characteristics or active current limitation detect at an early stage whether the nominal current has been exceeded.



### Multi-channel electronic circuit breakers

Safely protect against overload and short-circuit currents in a space-saving way. Thanks to multi-channel device circuit breakers, you can protect multiple circuits with just one single device, even in confined spaces. All channels can be individually adjusted and can therefore be adjusted as required to the connected loads. An integrated electronic interlock secures and protects the parameters you have set from unwanted changes. Push-in connection technology enables quick and tool-free installation of the devices.

All devices provide constant status checks on the individual channels. The multi-stage status indicator reliably informs you of the current status of the circuit. An early warning is also emitted that indicates utilization over 80%. All devices also have a remote indication contact.

Thanks to electronic tripping in the event of a short circuit, the faulty channels are switched off particularly quickly and precisely.

### CBMC compact device circuit breaker

With the compact device circuit breakers, you can protect four channels with just one device. The product range offers two versions with setting options for the nominal current from 1 A to 4 A or 1 A to 10 A. The 1-4 A version provides optimum protection for cables and sensors as well as NEC class 2 circuits by means of an adjusted internal output fuse.

The device circuit breakers can be ordered preconfigured. This means the devices are tailored exactly to your system and can be installed and connected directly.

### CBM highly functional device circuit breaker

The CBM device circuit breakers protect four or eight channels. Both devices protect nominal currents up to 10 A. A nominal current assistant helps you to correctly adjust the channels and makes installation especially easy. The CBM has a Reset IN connection, so that disconnected channels can be switched back on again remotely. Furthermore, the device provides the option of signaling utilization over 80% via the remote indication contact.

Thanks to the active current limitation, the current does not exceed a set threshold value in the event of a short circuit. This reduces the load on the power supply, thereby preventing a voltage drop.

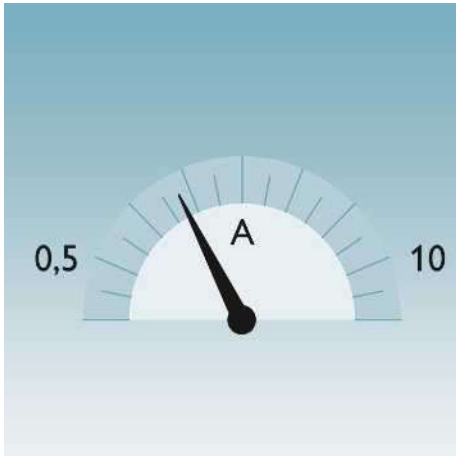

### Incremental adjustment

The multi-channel electronic circuit breakers have fine nominal current grading. The CBM can be adjusted in increments from 0.5 A to 10 A, the CBMC from 1 A to 4 A or 10 A, and set individually to the nominal currents of the connected terminal devices.

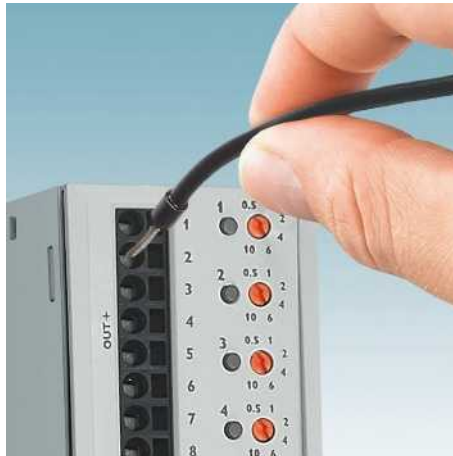

### Fast connection

Easy and tool-free direct plug-in. Push-in connection technology enables easy and direct insertion of solid and stranded conductors without the need for great force.



### Easy to configure

Configuring the CBM could not be easier with the new nominal current assistant. It enables optimal adjustment of the load currents.

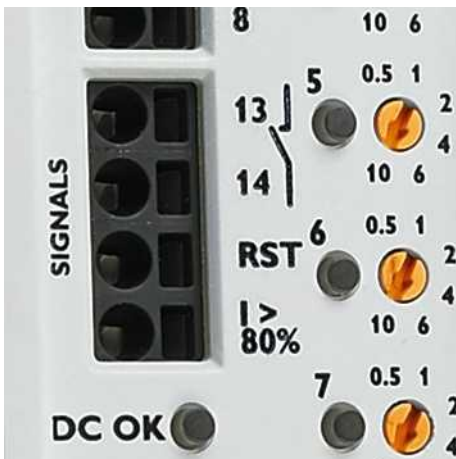

### Analysis and signaling

The currents flowing are constantly monitored. As such, the CBM not only provides the floating signal contact, but also an 80% output. Consequently, you receive a message when at least one channel is heavily overloaded. The disconnected channel can then be easily switched back on remotely via the Reset IN signal input.

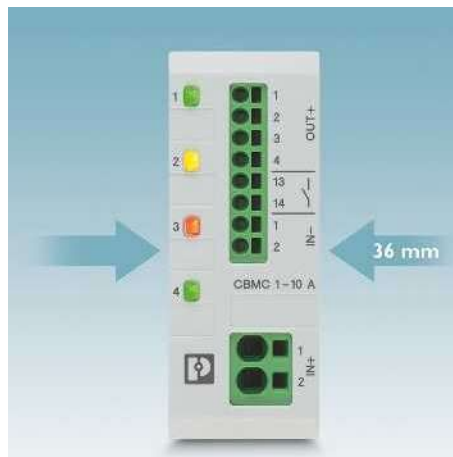

### Very compact

The CBMC protects four circuits against overload and short-circuit currents on just 36 mm. Thanks to adjustable nominal currents of 1 A to 4 A or 10 A in a single device, storage costs are reduced while simultaneously increasing flexibility for system planning.



### Can be ordered preconfigured

Order the CBMC device circuit breaker that is already configured for your system. This means the device can be used immediately, without further configuration effort. The preconfigured devices are also available with fixed, preprogrammed nominal current values.

# Device circuit breakers

## Multi-channel device circuit breakers

### Selection guide

#### CMB circuit breakers



**24 V DC**  
0.5 A ... 10 A  
4 channels

Page 314



**24 V DC**  
0.5 A ... 10 A  
8 channels

Page 314

#### CBMC circuit breakers



**24 V DC**  
1 A ... 4 A  
4 channels

Page 316



**24 V DC**  
1 A ... 10 A  
4 channels

Page 316



**24 V DC**  
1 A ... 4 A  
4 channels  
Can be ordered preconfigured

Page 317



**24 V DC**  
1 A ... 10 A  
4 channels  
Can be ordered preconfigured

Page 317

Applications

CBM device circuit breakers

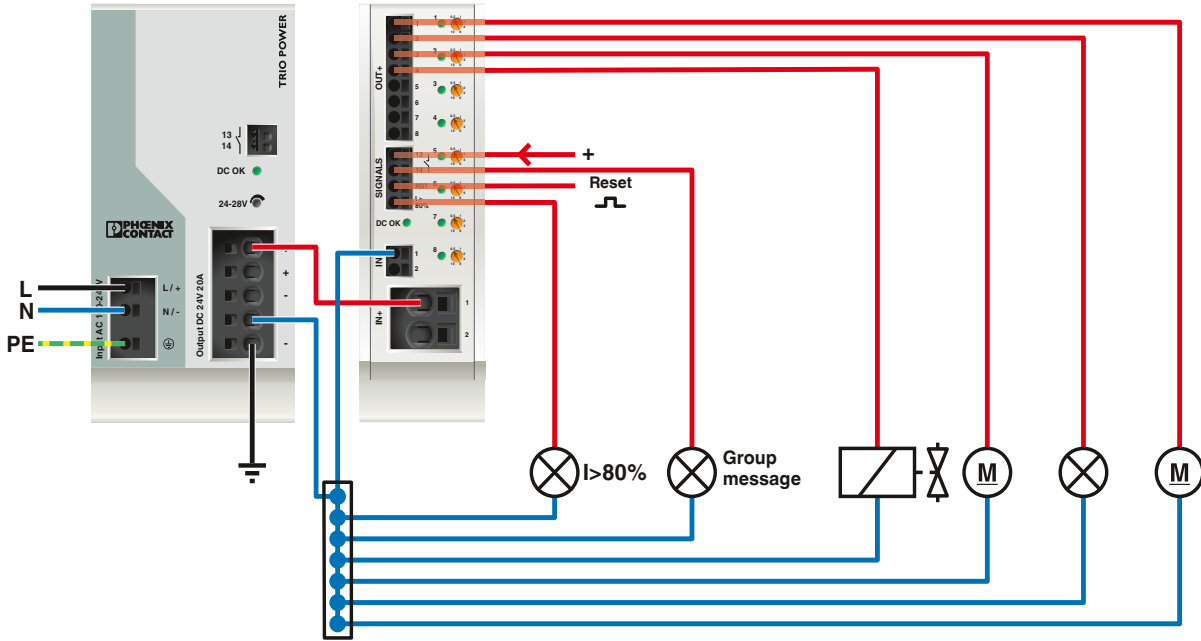

CBM

Page 314

CBMC device circuit breakers

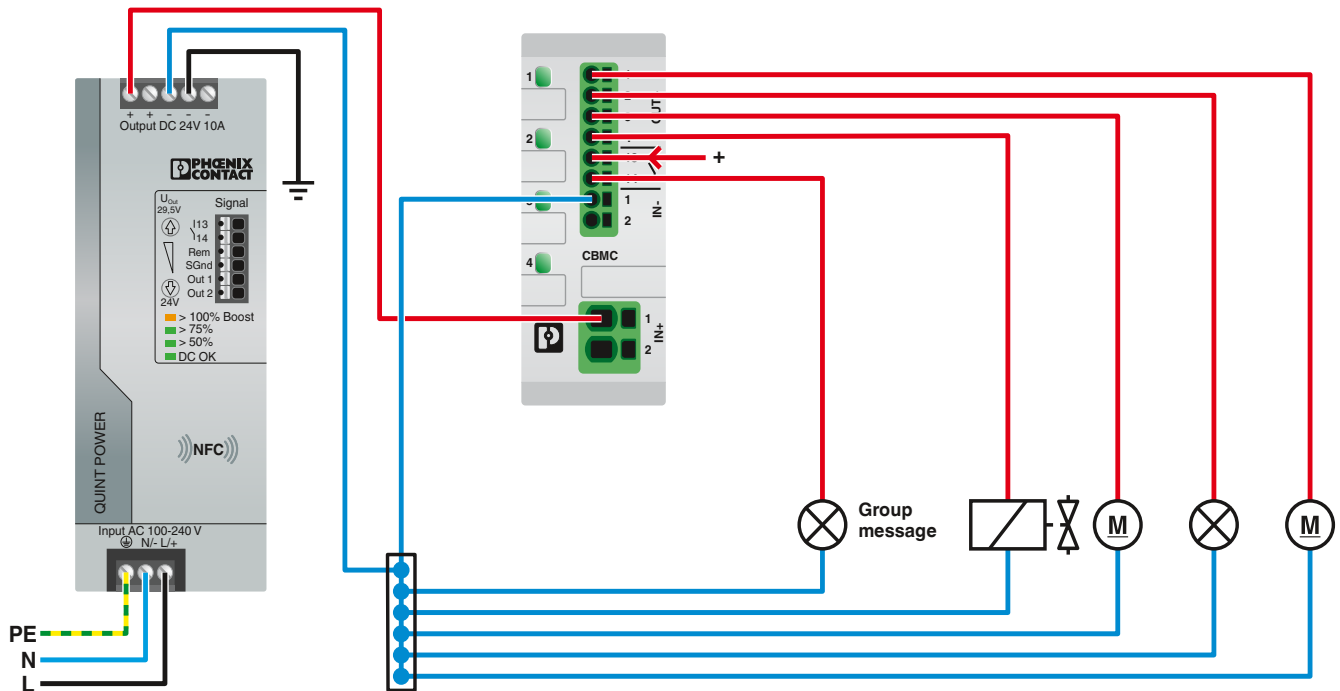

CBMC

Page 316

# Device circuit breakers

## Multi-channel device circuit breakers

### CBM electronic circuit breakers

- For protection against voltage dips caused by overload and short circuit
- Adjustable from 0.5 - 10 A
- Integrated dynamic current limitation
- Supply up to 80 A possible
- Slim design

**Notes:**  
For additional technical data, drawings, and accessories, please visit [phoenixcontact.net/products](http://phoenixcontact.net/products).



DIN-rail-mountable, 4-channel



DIN-rail-mountable, 8-channel



Electrical data	
Rated voltage	24 V DC
Rated current $I_N$	max. 40 A DC
Rated current $I_N$	0.5 / 1 / 2 / 4 / 6 / 10 A DC (adjustable per output channel)
Switch-on delay	0.1 s (per output channel)
Max. capacitive load	75000 $\mu$ F (per channel at 24 V DC)
Internal output fuse	15 A DC (per output channel)
Active current limitation	Typ. 2.0 x $I_N$ (0.5 - 1 A) / Typ. 1.5 x $I_N$ (2 - 10 A)
Load circuit	
Shutdown time	0.02 s ( $> 1.3 \times I_N$ ) / 30 s (1.1 ... 1.3 x $I_N$ )
Reset input	
Input voltage range	7 V DC ... 30 V DC (Falling edge)
General data	
Dimensions W/H/D	41 mm / 130 mm / 121 mm
Ambient temperature (operation)	-25 °C ... 70 °C (Startup at -40 C type-tested)
Standards/regulations	EN 61000-6-2 / EN 61000-6-3 / EN 60068-2-6 / EN 60068-2-11
Remote indication contact	
DC operating voltage	0 V DC ... 30 V DC
DC operating current	1 mA DC ... 100 mA

Technical data	
Rated voltage	24 V DC
Rated current $I_N$	max. 40 A DC
Rated current $I_N$	0.5 / 1 / 2 / 4 / 6 / 10 A DC (adjustable per output channel)
Switch-on delay	0.1 s (per output channel)
Max. capacitive load	75000 $\mu$ F (per channel at 24 V DC)
Internal output fuse	15 A DC (per output channel)
Active current limitation	Typ. 2.0 x $I_N$ (0.5 - 1 A) / Typ. 1.5 x $I_N$ (2 - 10 A)
Shutdown time	0.02 s ( $> 1.3 \times I_N$ ) / 30 s (1.1 ... 1.3 x $I_N$ )
Input voltage range	7 V DC ... 30 V DC (Falling edge)
Dimensions W/H/D	41 mm / 130 mm / 121 mm
Ambient temperature (operation)	-25 °C ... 70 °C (Startup at -40 C type-tested)
Standards/regulations	EN 61000-6-2 / EN 61000-6-3 / EN 60068-2-6 / EN 60068-2-11
DC operating voltage	0 V DC ... 30 V DC
DC operating current	1 mA DC ... 100 mA

Technical data	
Rated voltage	24 V DC
Rated current $I_N$	max. 80 A DC (for double supply IN+ with at least 2 x 6 mm <sup>2</sup> )
Rated current $I_N$	0.5 / 1 / 2 / 4 / 6 / 10 A DC (adjustable per output channel)
Switch-on delay	0.1 s (per output channel)
Max. capacitive load	75000 $\mu$ F (per channel at 24 V DC)
Internal output fuse	15 A DC (per output channel)
Active current limitation	Typ. 2.0 x $I_N$ (0.5 - 1 A) / Typ. 1.5 x $I_N$ (2 - 10 A)
Shutdown time	0.02 s ( $> 1.3 \times I_N$ ) / 30 s (1.1 ... 1.3 x $I_N$ )
Input voltage range	7 V DC ... 30 V DC (Falling edge)
Dimensions W/H/D	41 mm / 130 mm / 121 mm
Ambient temperature (operation)	-25 °C ... 70 °C (Startup at -40 C type-tested)
Standards/regulations	EN 61000-6-2 / EN 61000-6-3 / EN 60068-2-6 / EN 60068-2-11
DC operating voltage	0 V DC ... 30 V DC
DC operating current	1 mA DC ... 100 mA DC

Ordering data	
Description	Circuit breaker
Type	CBM E4 24DC/0.5-10A NO-R

Ordering data		
Type	Order No.	Pcs./Pkt.
CBM E4 24DC/0.5-10A NO-R	2905743	1

Ordering data		
Type	Order No.	Pcs./Pkt.
CBM E8 24DC/0.5-10A NO-R	2905744	1

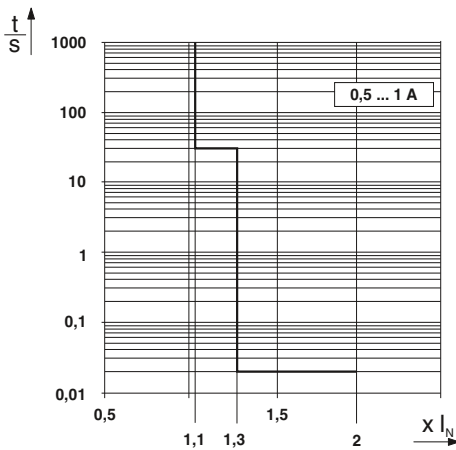

Tripping characteristic in the DC range

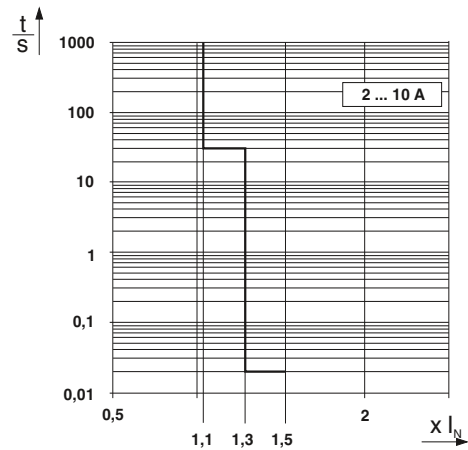

Tripping characteristic in the DC range



# Device circuit breakers

## Multi-channel device circuit breakers

### CBMC electronic circuit breakers

- For protection against voltage dips caused by overload and short circuit
- Adjustable in 1 A increments up to max. 10 A
- Compact design
- Suitable for NEC class 2 applications

**Notes:**  
For additional technical data, drawings, and accessories, please visit [phoenixcontact.net/products](http://phoenixcontact.net/products).



DIN-rail-mountable,  
4-channel

new



DIN-rail-mountable,  
4-channel

new



Technical data	
Rated voltage	24 V DC
Rated current $I_N$	max. 16 A DC
Rated current $I_N$	1 / 2 / 3 / 4 A DC (adjustable per output channel)
Switch-on delay	0.1 s (Cascaded per output channel)
Max. capacitive load	30000 $\mu$ F (Depending on the current setting and the short-circuit current available)
Internal output fuse	4 A DC (per output channel)
Active current limitation	-
<b>Load circuit</b>	
Shutdown time	$\leq 10$ ms (for short circuit $> 2.0 \times I_N$ ) / 1 s (1.2 ... 2.0 $\times I_N$ )
<b>General data</b>	
Dimensions W/H/D	36 mm / 90 mm / 98 mm
Ambient temperature (operation)	-25 °C ... 60 °C
Standards/regulations	EN 61000-6-2 / EN 61000-6-3 / EN 60068-2-78 / UL 508
<b>Remote indication contact</b>	
DC operating voltage	0 V DC ... 30 V DC
DC operating current	100 mA DC

Ordering data		
Type	Order No.	Pcs./Pkt.
CBMC E4 24DC/1-4A NO	2906031	1



Technical data	
Rated voltage	24 V DC
Rated current $I_N$	max. 40 A DC
Rated current $I_N$	1 / 2 / 3 / 4 / 5 / 6 / 7 / 8 / 9 / 10 A DC (adjustable per output channel)
Switch-on delay	0.1 s (Cascaded per output channel)
Max. capacitive load	45000 $\mu$ F (Depending on the current setting and the short-circuit current available)
Internal output fuse	15 A DC (per output channel)
Active current limitation	-
<b>Load circuit</b>	
Shutdown time	$\leq 10$ ms (for short circuit $> 2.0 \times I_N$ ) / 1 s (1.2 ... 2.0 $\times I_N$ )
<b>General data</b>	
Dimensions W/H/D	36 mm / 90 mm / 98 mm
Ambient temperature (operation)	-25 °C ... 60 °C
Standards/regulations	EN 61000-6-2 / EN 61000-6-3 / EN 60068-2-78 / UL 508
<b>Remote indication contact</b>	
DC operating voltage	0 V DC ... 30 V DC
DC operating current	100 mA DC

Ordering data		
Type	Order No.	Pcs./Pkt.
CBMC E4 24DC/1-10A NO	2906032	1

Description
Circuit breaker

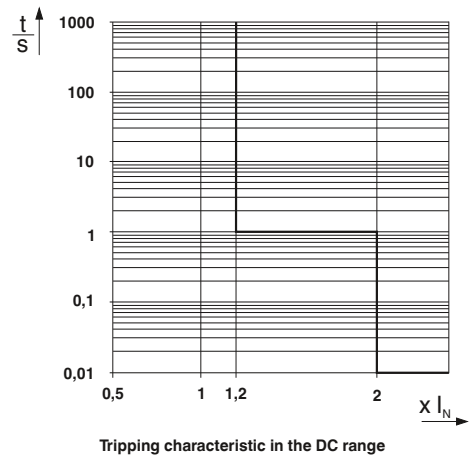
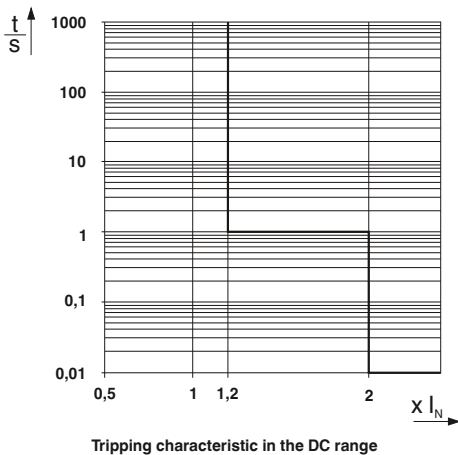

new



DIN-rail-mountable,  
4-channel, preconfigurable

new



DIN-rail-mountable,  
4-channel, preconfigurable



Technical data

<b>Electrical data</b>	
Rated voltage	24 V DC
Rated current $I_N$	max. 16 A DC
Rated current $I_N$	1 / 2 / 3 / 4 A DC (Adjustable or fixed per output channel)
Switch-on delay	0.1 s (Cascaded per output channel)
Max. capacitive load	30000 $\mu$ F (Depending on the current setting and the short-circuit current available)
Internal output fuse	4 A DC (per output channel)
Active current limitation	-
<b>Load circuit</b>	
Shutdown time	$\leq$ 10 ms (for short circuit $>$ 2.0 x $I_N$ ) / 1 s (1.2 ... 2.0 x $I_N$ )
<b>General data</b>	
Dimensions W/H/D	36 mm / 90 mm / 98 mm
Ambient temperature (operation)	-25 °C ... 60 °C
Standards/regulations	EN 61000-6-2 / EN 61000-6-3 / EN 60068-2-78 / UL 508
<b>Remote indication contact</b>	
DC operating voltage	0 V DC ... 30 V DC
DC operating current	100 mA DC



Technical data

<b>Electrical data</b>	
Rated voltage	24 V DC
Rated current $I_N$	max. 40 A DC
Rated current $I_N$	1 / 2 / 3 / 4 / 5 / 6 / 7 / 8 / 9 / 10 A DC (Adjustable or fixed per output channel)
Switch-on delay	0.1 s (Cascaded per output channel)
Max. capacitive load	45000 $\mu$ F (Depending on the current setting and the short-circuit current available)
Internal output fuse	15 A DC (per output channel)
Active current limitation	-
<b>Load circuit</b>	
Shutdown time	$\leq$ 10 ms (for short circuit $>$ 2.0 x $I_N$ ) / 1 s (1.2 ... 2.0 x $I_N$ )
<b>General data</b>	
Dimensions W/H/D	36 mm / 90 mm / 98 mm
Ambient temperature (operation)	-25 °C ... 60 °C
Standards/regulations	EN 61000-6-2 / EN 61000-6-3 / EN 60068-2-78 / UL 508
<b>Remote indication contact</b>	
DC operating voltage	0 V DC ... 30 V DC
DC operating current	100 mA DC

Ordering data

Description	Type	Order No.	Pcs./Pkt.
	Circuit breaker	CBMC E4 24DC/1-4A NO-C	2908713

Ordering data

Description	Type	Order No.	Pcs./Pkt.
	Circuit breaker	CBMC E4 24DC/1-10A NO-C	2908716

Order key for the device circuit breaker:  
CBMC E4 24DC/1-4A NO-C

Order No.	Adjustability	Channel 1	Channel 2	Channel 3	Channel 4
2908713	ADJ	1	3	1	4
	ADJ – adjustable	Select the current value in amperes individually for each channel			
	FIX – not adjustable	1 ... 4			

Order key for the device circuit breaker:  
CBMC E4 24DC/1-10A NO-C

Order No.	Adjustability	Channel 1	Channel 2	Channel 3	Channel 4
2908716	ADJ	1	5	8	10
	ADJ – adjustable	Select the current value in amperes individually for each channel			
	FIX – not adjustable	1 ... 10			



### Branch out

The device circuit breakers provide reliable protection even in systems with long cable paths. Together with the SFB Technology\* of the QUINT POWER power supplies, the special SFB tripping characteristic of the CB device circuit breakers ensures fast shutdown in the event of an error. This combination offers maximum protection against overload and short-circuit currents.

\*SFB = Selective Fuse Breaking, selective shutdown

### Modular extension

It couldn't be easier. A system can be extended with additional device circuit breakers in no time at all. You can bridge the power distribution, remote signaling or even the auxiliary voltage for electronic circuit breakers without this resulting in significant wiring costs. The uniform, plug-in housing concept as well as the bridgeability of the base elements simplify installation.

### Individual adaptation

Systems and control cabinets can be pre-wired with base elements and individually fitted with corresponding protective plugs on site. Should the demands on a load change in the meantime, you can simply replace the protective plug in question. Various tripping methods, tripping characteristics, and nominal currents are available depending on the application.



**Latching**

The new locking mechanism ensures a secure hold in harsh environments and where there are vibrations in the installation environment. It holds the plug securely in the base element. The plugs can be removed from the base element quickly and easily by simply applying light pressure to the locking mechanism.

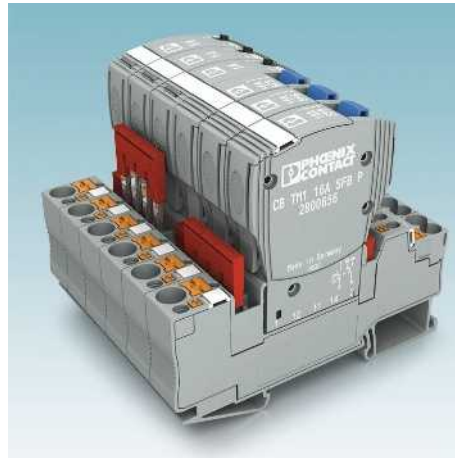

**Bridge**

With the unique bridge system from our standard range, the device circuit breakers can be combined easily as per your requirements. Potentials of the same type can be connected quickly and safely.



**Variable connection technologies**

Base elements are available with conventional screw connection technology or quick-to-wire Push-in connection technology.

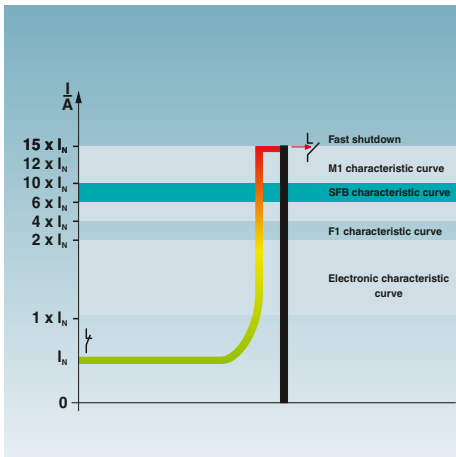

**SFB tripping characteristic**

Thermomagnetic device circuit breakers with the SFB tripping characteristic\* provide maximum overcurrent protection – even in large systems with long cable paths.

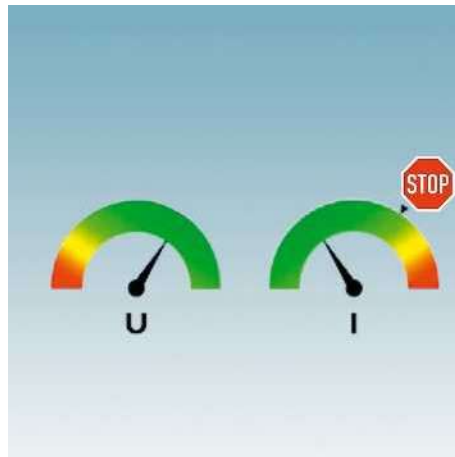

**Active current limitation**

The active current limitation of electronic device circuit breakers restricts short-circuit and overload currents to a value that is 1.25 to 2 times the nominal current. This protects the power supply against excessively high currents and prevents the output voltage dipping at the switched-mode power supply unit. In addition, longer cable paths between the power supply and load are possible without negatively impacting the shutdown behavior.

# Device circuit breakers

## Single-channel device circuit breakers

### Selection guide

#### Electronic device circuit breakers

**CB E1**



**24 V DC**  
1 A ... 10 A  
Page 322

**ECP-E**



**24 V DC**  
1 A ... 12 A  
Page 324

**ECP**



**24 V DC**  
1 A ... 10 A  
Page 325

**EC-E**



**24 V DC**  
0.5 A ... 12 A  
Page 326

#### Thermomagnetic device circuit breakers

**CB TM**



**50 V DC**  
**277 V AC**  
0.5 A ... 16 A  
Page 328

**UT6-TMC**



**28 V DC**  
**240 V AC**  
0.5 A ... 16 A  
Page 332

**TMC**



**65 V DC**  
**250 V AC**  
0.2 A ... 16 A  
Page 333

#### Thermal device circuit breakers

**TCP.../DC**



**32 V DC**  
5 A ... 40 A  
Page 334

**TCP**



**65 V DC**  
**250 V AC**  
0.25 A ... 10 A  
Page 335

Applications

Protecting 24 V loads

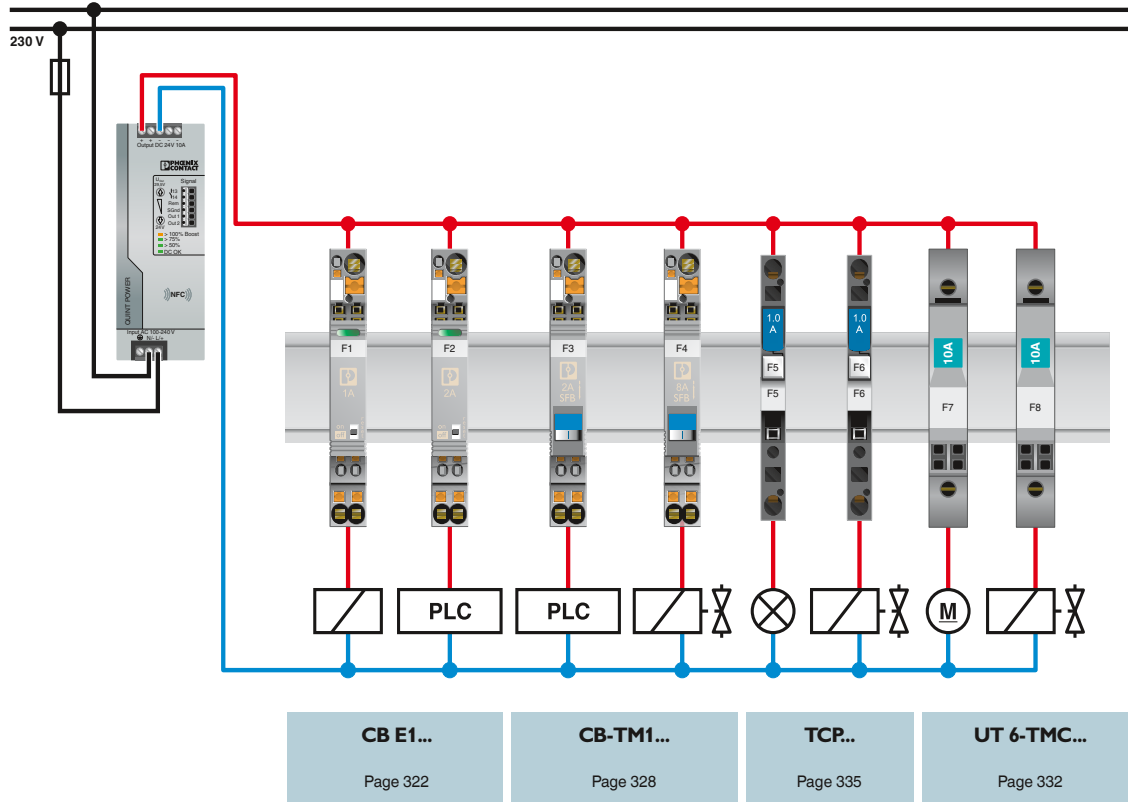

Enhanced functionality through digital signals

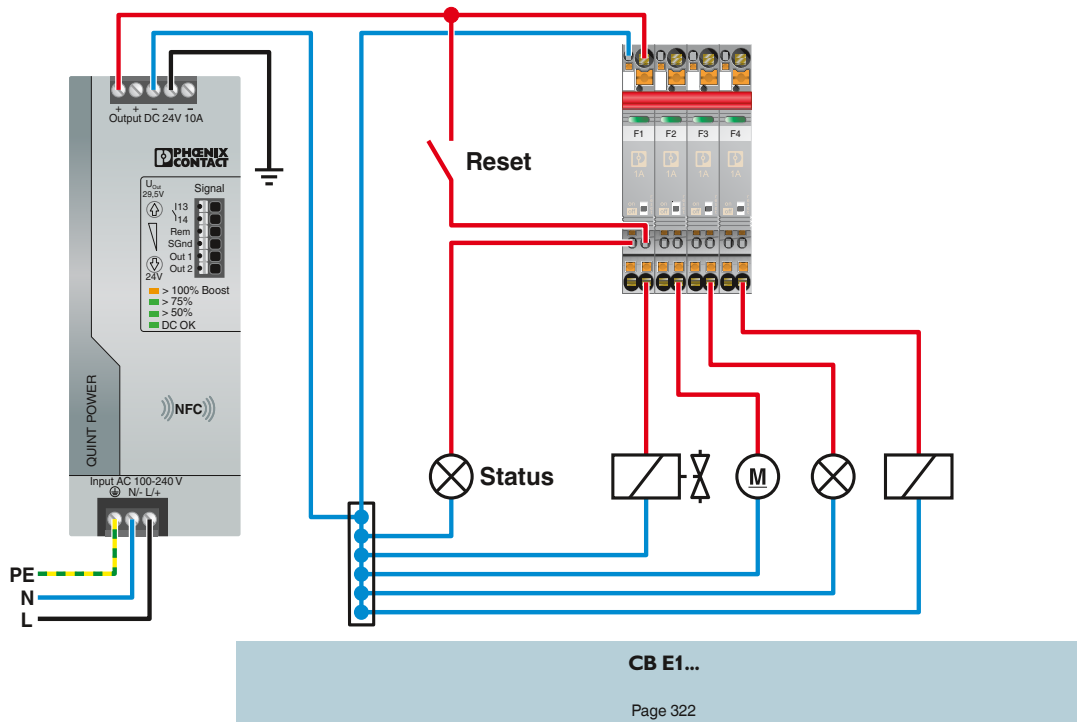

# Device circuit breakers

## Single-channel device circuit breakers

### Plug-in electronic circuit breakers

- Device circuit breakers for protecting against voltage dips caused by overloads and short circuits
- Integrated active current limitation
- Remote control possible
- Maximum ease of maintenance thanks to the two-piece design
- Snap-in function for secure hold and easy removal
- Plug coding possible
- Slim design

**Notes:**  
 In conjunction with order numbers 2800929 and 2801305, the items also satisfy UL 508.  
 For additional technical data, drawings, and accessories, please visit phoenixcontact.net/products.

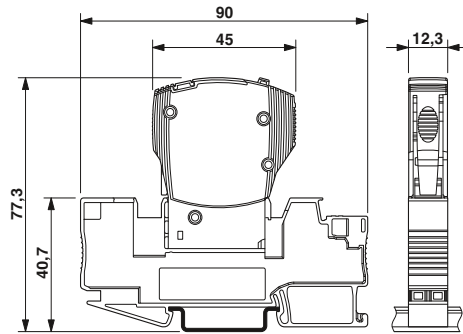

The figure shows the complete module consisting of a base element and plug



1 N/O contact

UL ENEC VDE CE  
 Total width 12.3 mm

#### Technical data

Operating voltage: 24 V DC  
 Nominal current  $I_N$ : Depends on the product version selected  
 Disconnection: See tripping characteristic  
 Active current limitation: typ. 1.25 x  $I_N$   
 General data: Ambient temperature (operation): -25 °C ... 50 °C (non-condensing)  
 Degree of protection: IP30 (Actuation area)  
 Standards/regulations: UL 2367 / UL 508 / EN 61000-6-3 / EN 61000-6-2

#### Ordering data

Description	Nominal current
Electronic circuit breaker, 1-pos.	
	1 A
	2 A
	3 A
	4 A
	6 A
	8 A
	10 A

Type	Order No.	Pcs./Pkt.
CB E1 24DC/1A NO P	2800901	1
CB E1 24DC/2A NO P	2800902	1
CB E1 24DC/3A NO P	2800903	1
CB E1 24DC/4A NO P	2800904	1
CB E1 24DC/6A NO P	2800905	1

#### Accessories

Bridge plug, 0 volt distribution  
 Base element  
 With Push-in connection technology  
 With screw connection technology  
 For the PCB

Accessories	Order No.	Pcs./Pkt.
CB PT BRIDGE	2801014	1
CB 1/6-2/4 PT-BE	2800929	10
CB 1/10-1/10 UT-BE	2801305	10
CB S-BE	2905067	30

Plug-in bridge, for cross connections in the bridge shaft

For FBS ..., see page 331

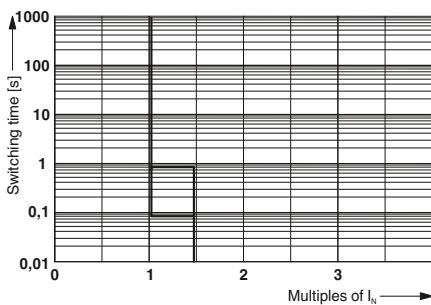

Tripping characteristic



1 N/C contact



1 x Status OUT + 1 x Reset IN



1 x Status OUT + 1 x Control IN

Total width 12.3 mm

Total width 12.3 mm

Total width 12.3 mm

Technical data
24 V DC Depends on the product version selected
See tripping characteristic typ. 1.25 x I <sub>N</sub>
-25 °C ... 50 °C (non-condensing) IP30 (Actuation area) UL 2367 / UL 508 / EN 61000-6-3 / EN 61000-6-2

Technical data
24 V DC Depends on the product version selected
See tripping characteristic typ. 1.25 x I <sub>N</sub>
-25 °C ... 50 °C (non-condensing) IP30 (Actuation area) UL 2367 / UL 508 / EN 61000-6-3 / EN 61000-6-2

Technical data
24 V DC Depends on the product version selected
See tripping characteristic typ. 1.25 x I <sub>N</sub>
-25 °C ... 50 °C (non-condensing) IP30 (Actuation area) UL 2367 / UL 508 / EN 61000-6-3 / EN 61000-6-2

Ordering data		
Type	Order No.	Pcs./Pkt.
CB E1 24DC/1A NC P	2800915	1
CB E1 24DC/2A NC P	2800916	1
CB E1 24DC/3A NC P	2800917	1
CB E1 24DC/4A NC P	2800918	1
CB E1 24DC/6A NC P	2800919	1

Ordering data		
Type	Order No.	Pcs./Pkt.
CB E1 24DC/1A S-R P	2800908	1
CB E1 24DC/2A S-R P	2800909	1
CB E1 24DC/3A S-R P	2800910	1
CB E1 24DC/4A S-R P	2800911	1
CB E1 24DC/6A S-R P	2800912	1
CB E1 24DC/8A S-R P	2800913	1
CB E1 24DC/10A S-R P	2800914	1

Ordering data		
Type	Order No.	Pcs./Pkt.
CB E1 24DC/1A S-C P	2800922	1
CB E1 24DC/2A S-C P	2800923	1
CB E1 24DC/3A S-C P	2800924	1
CB E1 24DC/4A S-C P	2800925	1
CB E1 24DC/6A S-C P	2800926	1
CB E1 24DC/8A S-C P	2800927	1
CB E1 24DC/10A S-C P	2800928	1

Accessories		
Type	Order No.	Pcs./Pkt.
CB PT BRIDGE	2801014	1
CB 1/6-2/4 PT-BE	2800929	10
CB 1/10-1/10 UT-BE	2801305	10
CB S-BE	2905067	30

Accessories		
Type	Order No.	Pcs./Pkt.
CB PT BRIDGE	2801014	1
CB 1/6-2/4 PT-BE	2800929	10
CB 1/10-1/10 UT-BE	2801305	10
CB S-BE	2905067	30

Accessories		
Type	Order No.	Pcs./Pkt.
CB PT BRIDGE	2801014	1
CB 1/6-2/4 PT-BE	2800929	10
CB 1/10-1/10 UT-BE	2801305	10
CB S-BE	2905067	30

For FBS ..., see page 331

For FBS ..., see page 331

For FBS ..., see page 331

# Device circuit breakers

## Single-channel device circuit breakers

### Plug-in electronic circuit breakers

- Device circuit breakers for protecting against voltage dips caused by overloads and short circuits
- Integrated active current limitation
- Remote control possible
- Maximum ease of maintenance thanks to the two-piece design
- Snap-in function for secure hold and easy removal
- Plug coding possible
- Slim design

**Notes:**  
For further technical data, drawings, and accessories, and a complete data sheet, please visit [phoenixcontact.net/products](http://phoenixcontact.net/products).

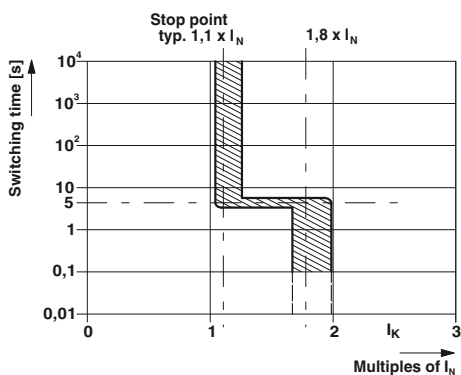

With reset input and status output

ERC   
Ex:   
Total width 12.5 mm

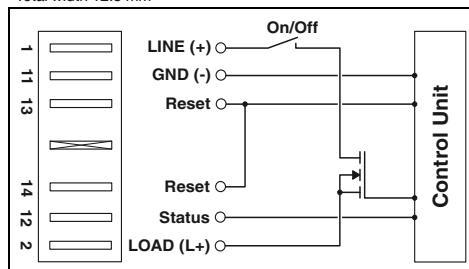

Electrical data	
Operating voltage	24 V DC
Nominal current $I_N$	Depends on the product version selected
Disconnection	
Switch-off time	See tripping characteristic
Switch off	Typ. $1.8 \times I_N$
Active current limitation	active
General data	
Temperature range	0 °C ... 50 °C (non-condensing)
Degree of protection	IP30 (Actuation area)
Standards/regulations	UL 2367 / UL 508 / CSA 22.2

Technical data		
Operating voltage	24 V DC	
Nominal current $I_N$	Depends on the product version selected	
Disconnection		
Switch-off time	See tripping characteristic	
Switch off	Typ. $1.8 \times I_N$	
Active current limitation	active	
General data		
Temperature range	0 °C ... 50 °C (non-condensing)	
Degree of protection	IP30 (Actuation area)	
Standards/regulations	UL 2367 / UL 508 / CSA 22.2	

Description	Nominal current
<b>Electronic circuit breaker</b> , can be plugged into TMCP base, signaling via LED	1 A
	2 A
	3 A
	4 A
	6 A
	8 A
	10 A
12 A	
<b>Electronic circuit breaker</b> , as above, but nominal current can be set via a switch, 1 A and 2 A	1 A
	(adjustable)
<b>Electronic circuit breaker</b> , as above, but nominal current can be set via a switch, 3 A and 6 A	3 A
	(adjustable)

Ordering data		
Type	Order No.	Pcs./Pkt.
ECP-E 1A	0900113	5
ECP-E 2A	0900210	5
ECP-E 3A	0900317	5
ECP-E 4A	0900414	5
ECP-E 6A	0900618	5
ECP-E 8A	0900812	5
ECP-E 10A	0901002	5
ECP-E-12A	0900126	5

Accessories	
<b>Spring lock</b> , for mechanical locking in the case of overhead mounting, 1-pos.	SPRING-LOCK
<b>Modular socket</b> , 2-position, for holding two circuit breakers, each with a single position	TMCP SOCKET M
<b>Socket termination elements</b> , can be plugged in both left and right, contain the connections for the reset inputs/group query	TMCP CONNECT LR
<b>Signal bridge</b> , pluggable, for bridging group signaling when there is a free slot on the TMCP SOCKET M socket	TMCP SB

Accessories		
Accessories	Order No.	Pcs./Pkt.
SPRING-LOCK	0713009	10
TMCP SOCKET M	0916589	10
TMCP CONNECT LR	0916592	3
TMCP SB	0916602	6



With control input and group request



With reset input and group request



With floating signal contact and electrical isolation

ERAC  
Ex:   
Total width 12.5 mm

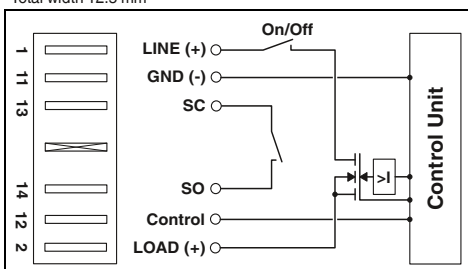

ERAC  
Ex:   
Total width 12.5 mm

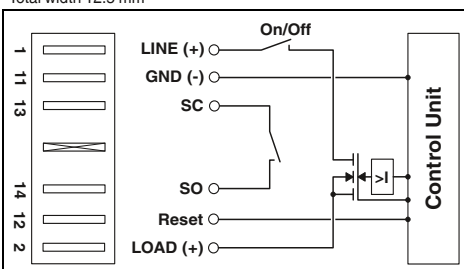

ERAC   
Total width 12.5 mm

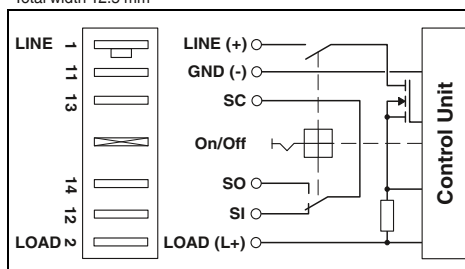

### Technical data

24 V DC  
Depends on the product version selected

See tripping characteristic  
Typ.  $1.8 \times I_N$   
active

0 °C ... 50 °C (non-condensing)  
IP30 (Actuation area)  
UL 2367 / UL 508 / CSA 22.2

### Ordering data

Type	Order No.	Pcs./Pkt.
ECP-E2-1A	0900139	5
ECP-E2-2A	0900236	5
ECP-E2-3A	0900333	5
ECP-E2-4A	0900430	5
ECP-E2-6A	0900634	5
ECP-E2-8A	0900838	5
ECP-E2-10A	0900100	5
ECP-E2-12A	0900207	5

### Technical data

24 V DC  
Depends on the product version selected

See tripping characteristic  
Typ.  $1.8 \times I_N$   
active

0 °C ... 50 °C (non-condensing)  
IP30 (Actuation area)  
UL 2367 / UL 508 / CSA 22.2

### Ordering data

Type	Order No.	Pcs./Pkt.
ECP-E3 1A	0912041	5
ECP-E3 2A	0912042	5
ECP-E3 3A	0912043	5
ECP-E3 4A	0912044	5
ECP-E3 6A	0912046	5
ECP-E3 8A	0912048	5
ECP-E3 10A	0912050	5
ECP-E3 12A	0912052	5

### Technical data

24 V DC  
Depends on the product version selected

See tripping characteristic  
Typ.  $1.8 \times I_N$   
active

0 °C ... 50 °C (non-condensing)  
IP30 (Actuation area)  
-

### Ordering data

Type	Order No.	Pcs./Pkt.
ECP 2	0911034	5
ECP 3	0911047	5
ECP 4	0912034	5
ECP 6	0912033	5
ECP 8	0912019	5
ECP 10	0912020	5
ECP 1-2	0912018	5
ECP 3-6	0916536	5

### Accessories

Accessories	Order No.	Pcs./Pkt.
SPRING-LOCK	0713009	10
TMCP SOCKET M	0916589	10
TMCP CONNECT LR	0916592	3
TMCP SB	0916602	6

### Accessories

Accessories	Order No.	Pcs./Pkt.
SPRING-LOCK	0713009	10
TMCP SOCKET M	0916589	10
TMCP CONNECT LR	0916592	3
TMCP SB	0916602	6

### Accessories

Accessories	Order No.	Pcs./Pkt.
SPRING-LOCK	0713009	10
TMCP SOCKET M	0916589	10
TMCP CONNECT LR	0916592	3
TMCP SB	0916602	6

# Device circuit breakers

## Single-channel device circuit breakers

### EC-E1 and EC-E4 electronic circuit breakers

- Selective protection of all load circuits at switched-mode power supply units
- A combination of active electronic current limitation in the event of short circuit and overload shutdown ensures that the circuit breaker can respond to overloads faster than the switched-mode power supply unit
- The residual current is always limited to 1.3 - 1.8 times the nominal current

**Notes:**  
For further technical data, drawings, and accessories, and a complete data sheet, please visit [phoenixcontact.net/products](http://phoenixcontact.net/products).

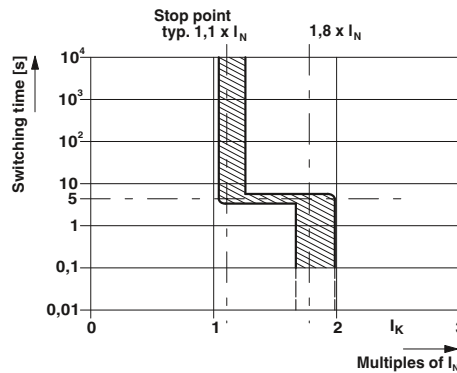

With signal contact as N/C contact or N/O contact

Ex: Total width 12.5 mm

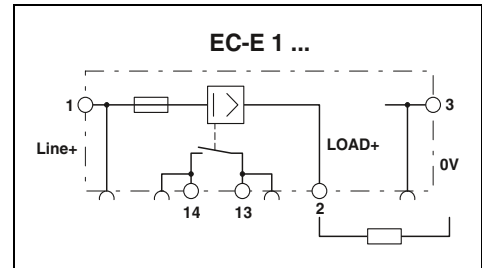

Electrical data	
Operating voltage	24 V DC
Nominal current $I_N$	Depends on the product version selected
Disconnection	
Switch-off time	See tripping characteristic
Fuse type	Electronic
General data	
Dimensions W/H/D	12.5 mm / 83 mm / 80 mm
Connection method	Screw connection
Connection data solid/stranded/AWG	0.5 ... 16 mm <sup>2</sup> / 0.5 ... 16 mm <sup>2</sup> / 20 - 6
Stranded conductor cross section with ferrule	0.5 ... 10 mm <sup>2</sup>
Ambient temperature (operation)	0 °C ... 50 °C (non-condensing)
Degree of protection	IP20 (Housing)
Flammability rating according to UL 94	V0

#### Technical data

Operating voltage	24 V DC
Nominal current $I_N$	Depends on the product version selected
Disconnection	
Switch-off time	See tripping characteristic
Fuse type	Electronic
General data	
Dimensions W/H/D	12.5 mm / 83 mm / 80 mm
Connection method	Screw connection
Connection data solid/stranded/AWG	0.5 ... 16 mm <sup>2</sup> / 0.5 ... 16 mm <sup>2</sup> / 20 - 6
Stranded conductor cross section with ferrule	0.5 ... 10 mm <sup>2</sup>
Ambient temperature (operation)	0 °C ... 50 °C (non-condensing)
Degree of protection	IP20 (Housing)
Flammability rating according to UL 94	V0

Description	Nominal current
<b>Electronic circuit breaker, signal contact: 1 N/O contact</b>	
	0.5 A
	1 A
	2 A
	3 A
	4 A
	6 A
	8 A
	10 A
	12 A
<b>Electronic circuit breaker, signal contact: 1 N/C contact</b>	
	0.5 A
	1 A
	2 A
	3 A
	4 A
	6 A
	8 A
	10 A
	12 A

#### Ordering data

Type	Order No.	Pcs./Pkt.
EC-E1 0.5A	0903022	6
EC-E1 1A	0903023	6
EC-E1 2A	0903024	6
EC-E1 3A	0903025	6
EC-E1 4A	0903026	6
EC-E1 6A	0903028	6
EC-E1 8A	0903029	6
EC-E1 10A	0903030	6
EC-E1 12A	0903031	6
EC-E4 0.5A	0903040	6
EC-E4 1A	0903032	6
EC-E4 2A	0903033	6
EC-E4 3A	0903034	6
EC-E4 4A	0903035	6
EC-E4 6A	0903036	6
EC-E4 8A	0903037	6
EC-E4 10A	0903038	6
EC-E4 12A	0903039	6

<b>Cont. plug-in bridge</b> , 500 mm long, isolated, can be cut to length, for potential distribution
Nominal current: 32 A
<b>Screwdriver</b>

#### Accessories

FBST 500-PLC BU	2966692	20
FBST 500-PLC RD	2966786	20
FBST 500 TMC-N GY	0901028	10
SZS 0.6X3,5	1205053	10

EC-E electronic circuit breakers

- Selective protection of all 24 V DC load circuits at switched-mode power supply units
- A combination of active electronic current limitation in the event of short circuit and overload shutdown ensures that the circuit breaker can respond to overloads faster than the switched-mode power supply unit
- The residual current is always limited to 1.3 - 1.8 times the nominal current

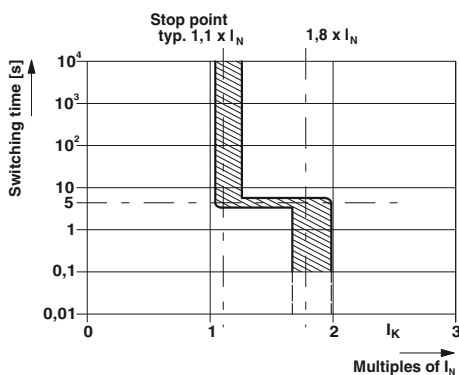

With reset input and status output

**Notes:**  
For further technical data, drawings, and accessories, and a complete data sheet, please visit [phoenixcontact.net/products](http://phoenixcontact.net/products).

Ex: Total width 12.5 mm

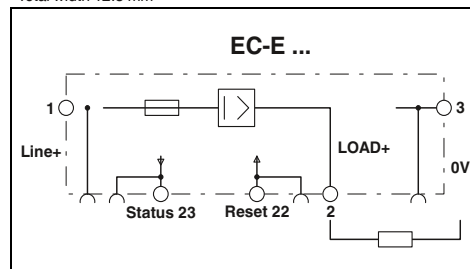

Electrical data	
Operating voltage	24 V DC
Nominal current $I_N$	Depends on the product version selected
Disconnection	
Switch-off time	See tripping characteristic
Fuse type	Electronic
General data	
Dimensions W/H/D	12.5 mm / 83 mm / 80 mm
Connection method	Screw connection
Connection data solid/stranded/AWG	0.5 ... 16 mm <sup>2</sup> / 0.5 ... 16 mm <sup>2</sup> / 26 - 6
Stranded conductor cross section with ferrule	0.5 ... 10 mm <sup>2</sup>
Ambient temperature (operation)	0 °C ... 50 °C (non-condensing)
Degree of protection	IP20 (Housing)
Flammability rating according to UL 94	V0

Technical data

Operating voltage	24 V DC
Nominal current $I_N$	Depends on the product version selected
Switch-off time	See tripping characteristic
Fuse type	Electronic
Dimensions W/H/D	12.5 mm / 83 mm / 80 mm
Connection method	Screw connection
Connection data solid/stranded/AWG	0.5 ... 16 mm <sup>2</sup> / 0.5 ... 16 mm <sup>2</sup> / 26 - 6
Stranded conductor cross section with ferrule	0.5 ... 10 mm <sup>2</sup>
Ambient temperature (operation)	0 °C ... 50 °C (non-condensing)
Degree of protection	IP20 (Housing)
Flammability rating according to UL 94	V0

Description	Nominal current
<b>Electronic circuit breaker, with reset input</b>	
	0.5 A
	1 A
	2 A
	3 A
	4 A
	6 A
	8 A
	10 A
	12 A

Ordering data

Type	Order No.	Pcs./Pkt.
EC-E 0.5A DC24V	0903041	6
EC-E 1A DC24V	0903042	6
EC-E 2A DC24V	0903043	6
EC-E 3A DC24V	0903044	6
EC-E 4A DC24V	0903045	6
EC-E 6A DC24V	0903046	6
EC-E 8A DC24V	0903047	6
EC-E 10A DC24V	0903048	6
EC-E 12A DC24V	0903049	6

<b>Cont. plug-in bridge, 500 mm long, isolated, can be cut to length, for potential distribution</b>
Nominal current: 32 A

Accessories

FBST 500-PLC BU	2966692	20
FBST 500-PLC RD	2966786	20
FBST 500 TMC-N GY	0901028	10

# Device circuit breakers

## Single-channel device circuit breakers

### Plug-in thermomagnetic circuit breakers

- Device circuit breakers for protecting against voltage dips caused by overloads and short circuits
- SFB characteristic curve enables longer cables and tripping times of < 10 ms
- Maximum ease of maintenance thanks to the two-piece design
- Snap-in function for secure hold and easy removal
- Plug coding possible
- Slim design

#### Notes:

For additional technical data, drawings, and accessories, please visit [phoenixcontact.net/products](http://phoenixcontact.net/products).

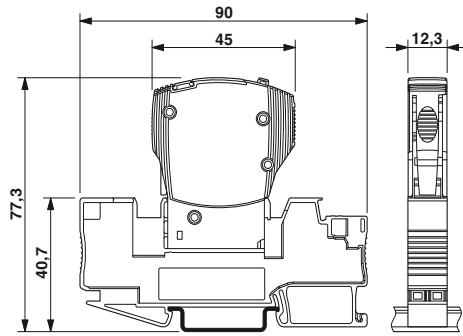

The figure shows the complete module consisting of a base element and plug



Can be plugged in, SFB characteristic curve



Total width 12.3 mm

#### Technical data

IEC	UL / CUL	CSA
50 V DC	50 V DC	-
Depends on the product version selected		

See tripping characteristic  
SFB  
- / 600 A (50 V DC)  
6000 (at 1 x I<sub>n</sub>)

-30 °C ... 60 °C  
IP30 (Actuation area)  
EN 60934 / UL 1077 / UL 508 / CSA 22.2

#### Ordering data

Description	Nominal current	Type	Order No.	Pcs./Pkt.
<b>Thermomagnetic circuit breaker, plug-in, 1-pos., signal contact 1 PDT</b>				
	0.5 A	CB TM1 0.5A SFB P	2800835	1
	1 A	CB TM1 1A SFB P	2800836	1
	2 A	CB TM1 2A SFB P	2800837	1
	3 A	CB TM1 3A SFB P	2800838	1
	4 A	CB TM1 4A SFB P	2800839	1
	5 A	CB TM1 5A SFB P	2800840	1
	6 A	CB TM1 6A SFB P	2800841	1
	8 A	CB TM1 8A SFB P	2800842	1
	10 A	CB TM1 10A SFB P	2800843	1
	12 A	CB TM1 12A SFB P	2800844	1
	16 A	CB TM1 16A SFB P	2800845	1
<b>Thermomagnetic circuit breaker, plug-in, 2-pos., signal contact 1 PDT</b>				
	0.5 A	CB TM2 0.5A SFB P	2800868	1
	1 A	CB TM2 1A SFB P	2800869	1
	2 A	CB TM2 2A SFB P	2800870	1
	3 A	CB TM2 3A SFB P	2800871	1
	4 A	CB TM2 4A SFB P	2800872	1
	5 A	CB TM2 5A SFB P	2800873	1
	6 A	CB TM2 6A SFB P	2800874	1
	8 A	CB TM2 8A SFB P	2800875	1
	10 A	CB TM2 10A SFB P	2800876	1
	12 A	CB TM2 12A SFB P	2800877	1
	16 A	CB TM2 16A SFB P	2800878	1

#### Accessories

Description	Type	Order No.	Pcs./Pkt.
<b>Bridge plug, 0 volt distribution</b>			
	CB PT BRIDGE	2801014	1
<b>Base element</b>			
With Push-in connection technology	CB 1/6-2/4 PT-BE	2800929	10
With screw connection technology	CB 1/10-1/10 UT-BE	2801305	10
For the PCB	CB S-BE	2905067	30

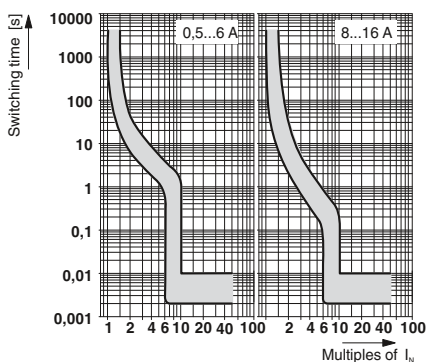

Tripping characteristic in the DC range



# Device circuit breakers

## Single-channel device circuit breakers

### Plug-in thermomagnetic circuit breakers

- Device circuit breakers for protecting against voltage dips caused by overloads and short circuits
- Medium-blow and fast-blow tripping characteristics
- 1 and 2-pos. circuit breakers
- Maximum ease of maintenance thanks to the two-piece design
- Snap-in function for secure hold and easy removal
- Plug coding possible
- Slim design



Can be plugged in, F1 characteristic curve, 1-pos.



Can be plugged in, F1 characteristic curve, 2-pos.



Electrical data	
Rated voltage	50 V DC
Nominal current $I_N$	Depends on the product version selected
Disconnection	
Switch-off time	See tripping characteristic
Fuse type	fast blow
Rated short-circuit switching capacity $I_{cn}$	- / 600 A (50 V DC)
Switching cycles, max.	6000 (at 1 x $I_n$ )
General data	
Ambient temperature (operation)	-30 °C ... 60 °C
Degree of protection	IP30 (Actuation area)
Standards/regulations	EN 60934 / UL 1077 / UL 508 / CSA 22.2

Technical data		
IEC	UL / CUL	CSA
50 V DC	50 V DC	-
Depends on the product version selected		
See tripping characteristic		
fast blow		
- / 600 A (50 V DC)		
6000 (at 1 x $I_n$ )		
-30 °C ... 60 °C		
IP30 (Actuation area)		
EN 60934 / UL 1077 / UL 508 / CSA 22.2		

Technical data		
IEC	UL / CUL	CSA
80 V DC	80 V DC	-
Depends on the product version selected		
See tripping characteristic		
fast blow		
- / 600 A (80 V DC)		
6000 (240 V AC/1 x $I_n$ )		
-30 °C ... 60 °C		
IP30 (Actuation area)		
EN 60934 / UL 1077 / UL 508 / CSA 22.2		

Description	Nominal current
Thermomagnetic circuit breaker, plug-in, signal contact 1 PDT	0.5 A
	1 A
	2 A
	3 A
	4 A
	5 A
	6 A
	8 A
	10 A
	12 A
	16 A

Ordering data		
Type	Order No.	Pcs./Pkt.
CB TM1 0.5A F1 P	2800857	1
CB TM1 1A F1 P	2800858	1
CB TM1 2A F1 P	2800859	1
CB TM1 3A F1 P	2800860	1
CB TM1 4A F1 P	2800861	1
CB TM1 5A F1 P	2800862	1
CB TM1 6A F1 P	2800863	1
CB TM1 8A F1 P	2800864	1
CB TM1 10A F1 P	2800865	1
CB TM1 12A F1 P	2800866	1
CB TM1 16A F1 P	2800867	1

Ordering data		
Type	Order No.	Pcs./Pkt.
CB TM2 0.5A F1 P	2800890	1
CB TM2 1A F1 P	2800891	1
CB TM2 2A F1 P	2800892	1
CB TM2 3A F1 P	2800893	1
CB TM2 4A F1 P	2800894	1
CB TM2 5A F1 P	2800895	1
CB TM2 6A F1 P	2800896	1
CB TM2 8A F1 P	2800897	1
CB TM2 10A F1 P	2800898	1
CB TM2 12A F1 P	2800899	1
CB TM2 16A F1 P	2800900	1

Bridge plug, 0 volt distribution	
Base element	With Push-in connection technology
	With screw connection technology
	For the PCB

Accessories		
CB PT BRIDGE	2801014	1
CB 1/6-2/4 PT-BE	2800929	10
CB 1/10-1/10 UT-BE	2801305	10
CB S-BE	2905067	30

Accessories		
CB PT BRIDGE	2801014	1
CB 1/6-2/4 PT-BE	2800929	10
CB 1/10-1/10 UT-BE	2801305	10
CB S-BE	2905067	30

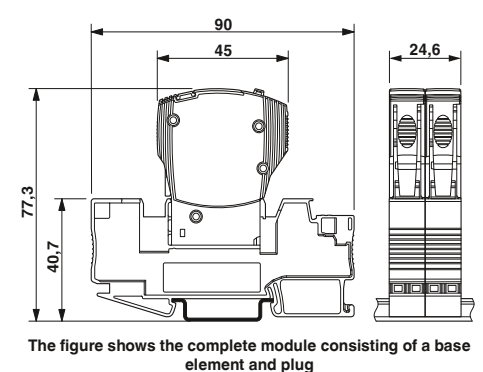
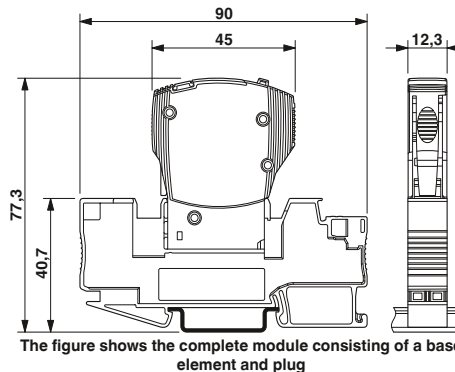
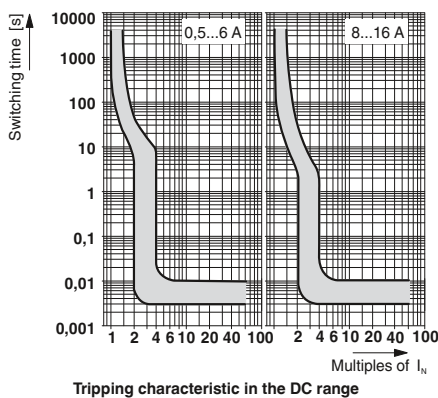

Base element and plug-in bridges

Base elements

- For accommodating CB TM.../CB E... device circuit breakers
- DIN rail module
- With bridge shafts
- Systematic structure with 1-channel base elements possible

**Notes:**  
Can be loaded with up to 41 A if two bridges are connected for the supply.

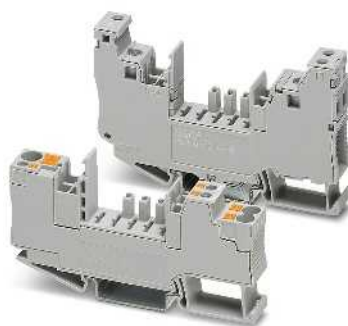

1-pos, with screw or Push-in connection technology



For the PCB

Technical data	
... PT-BE	... UT-BE
Rated surge voltage 4 kV	2.5 kV
Dimensions W/H/D 12.3 mm / 90 mm / 46.7 mm	12.3 mm / 90.8 mm / 70 mm
Connection method Push-in connection	Screw connection
Ambient temperature (operation) -30 °C ... 60 °C	-30 °C ... 60 °C
Degree of protection IP30 (Actuation area)	IP30 (Actuation area)
Flammability rating according to UL 94 V0	V0
Standards/regulations IEC 60947-7-1	UL 1059

Technical data	
Rated surge voltage -	
Dimensions W/H/D 12.3 mm / 34.8 mm / 36.4 mm	
Connection method Solder connection	
Ambient temperature (operation) -30 °C ... 60 °C	
Degree of protection IP30 (Plug-in area with plugged-in device) / IP00 (Connection area)	
Flammability rating according to UL 94 V-0	
Standards/regulations DIN EN 50155 / IEC 60068-2	

Ordering data			
Type	Order No.	Pcs./Pkt.	
CB 1/6-2/4 PT-BE	2800929	10	
CB 1/10-1/10 UT-BE	2801305	10	

Ordering data		
Type	Order No.	Pcs./Pkt.
CB S-BE	2905067	30

Accessories			
Plug-in bridge, red	Number of positions		
	2	FBS 2-6	3030336 50
	3	FBS 3-6	3030242 50
	4	FBS 4-6	3030255 50
	5	FBS 5-6	3030349 50
	10	FBS 10-6	3030271 10
	20	FBS 20-6	3030365 10
50	FBS 50-6	3032224 10	
Plug-in bridge, blue	Number of positions		
	2	FBS 2-6 BU	3036932 50
	3	FBS 3-6 BU	3036945 50
	4	FBS 4-6 BU	3036958 50
	5	FBS 5-6 BU	3036961 50
	10	FBS 10-6 BU	3032198 10
	20	FBS 20-6 BU	3032208 10
50	FBS 50-6 BU	3032211 10	
Plug-in bridge, gray	Number of positions		
	2	FBS 2-6 GY	3032237 50
	3	FBS 3-6 GY	3032240 50
	4	FBS 4-6 GY	3032279 50
	5	FBS 5-6 GY	3032266 50
10	FBS 10-6 GY	3032253 10	

Accessories		

# Device circuit breakers

## Single-channel device circuit breakers

### Thermomagnetic circuit breaker UT 6-TMC ...

- Thermomagnetic circuit breakers feature a compact design, large-surface marking options, and a double plug-in bridge shaft
- With bridge shafts enabling them to be bridged together easily
- 12.3 mm compact design
- High level of system availability thanks to their reclosure function and clear status display
- Eleven nominal current levels can be selected from 0.5 A to 16 A
- Clear assignment of the relevant circuit breaker thanks to the large center marking area

**Notes:**  
For further technical data, drawings, and accessories, and a complete data sheet, please visit [phoenixcontact.net/products](http://phoenixcontact.net/products).



DIN-rail-mountable

CE, UL, EAC, RoHS, REACH  
Total width 12.3 mm

Electrical data	
Rated voltage	240 V AC
Rated voltage	28 V DC
Nominal current $I_N$	Depends on the product version selected
Disconnection	
Switch-off time	See tripping characteristic
Fuse type	Normal blow (M1)
Rated short-circuit switching capacity $I_{cn}$	200 A (240 V AC) / 400 A (28 V DC)
Switching cycles, max.	6000 (at 1 x $I_n$ )
General data	
Dimensions W/H/D	12.3 mm / 85.5 mm / 89.5 mm
Connection method	Screw connection
Connection data solid/stranded/AWG	0.2 ... 10 mm <sup>2</sup> / 0.2 ... 10 mm <sup>2</sup> / 24 - 8
Stranded conductor cross section with ferrule	0.25 ... 6 mm <sup>2</sup>
Ambient temperature (operation)	-30 °C ... 60 °C
Degree of protection	IP40 (Actuation area) / IP20 (Connection area)
Standards/regulations	EN 60934 / UL 1077 / CSA 22.2 / EAC

Technical data		
IEC	UL / CUL	CSA
240 V AC	240 V AC	-
28 V DC	28 V DC	-
Depends on the product version selected		
See tripping characteristic		
Normal blow (M1)		
200 A (240 V AC) / 400 A (28 V DC)		
6000 (at 1 x $I_n$ )		

Description	Nominal current
Thermomagnetic circuit breaker, for mounting on NS 35...	
	0.5 A
	1 A
	2 A
	4 A
	5 A
	6 A
	8 A
	10 A
	12 A
	15 A
	16 A

Ordering data		
Type	Order No.	Pcs./Pkt.
UT 6-TMC M 0.5A	0916603	6
UT 6-TMC M 1A	0916604	6
UT 6-TMC M 2A	0916605	6
UT 6-TMC M 4A	0916606	6
UT 6-TMC M 5A	0916607	6
UT 6-TMC M 6A	0916608	6
UT 6-TMC M 8A	0916609	6
UT 6-TMC M 10A	0916610	6
UT 6-TMC M 12A	0916611	6
UT 6-TMC M 15A	0916612	6
UT 6-TMC M 16A	0916613	6

Plug-in bridge, red	Number of positions
	2
	3
	4
	5
	10
	20

Accessories		
FBS 2-6	3030336	50
FBS 3-6	3030242	50
FBS 4-6	3030255	50
FBS 5-6	3030349	50
FBS 10-6	3030271	10
FBS 20-6	3030365	10

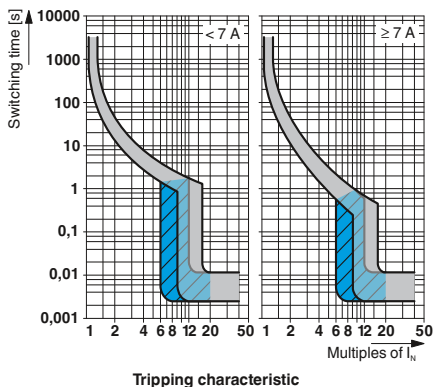

### TMC thermomagnetic circuit breaker

- Available with fast-blow and medium-blow characteristic curve for various nominal current strengths
- Single or two-pos. main current path



DIN-rail-mountable

<b>Notes:</b>
1) Main contact
For further technical data, drawings, and accessories, and a complete data sheet, please visit <a href="http://phoenixcontact.net/products">phoenixcontact.net/products</a> .



Total width 12.5 mm

#### Technical data

Electrical data	IEC	UL / CUL	CSA
Rated voltage	250 V AC	-	-
Rated voltage	65 V DC	-	-
Nominal current $I_N$	Depends on the product version selected		
Disconnection			
Switch-off time	See tripping characteristic		
Fuse type	Fast blow (F1)		
Rated short-circuit switching capacity $I_{cn}$	400 A / 2500 A (32 V DC)		
General data			
Dimensions W/H/D	12.5 mm / 82.5 mm / 96 mm		
Connection method	Screw connection		
Connection data solid/stranded/AWG	0.2 ... 6 mm <sup>2</sup> / 0.2 ... 4 mm <sup>2</sup> / 24 - 10		
Stranded conductor cross section with ferrule	0.25 ... 4 mm <sup>2</sup>		
Ambient temperature (operation)	-30 °C ... 60 °C		
Degree of protection	IP30 (Actuation area) / IP20 (Connection area)		

#### Ordering data

Description	Nominal current	Type	Order No.	Pcs./Pkt.
<b>Thermomagnetic circuit breaker</b> , with universal foot for mounting on NS 32... or NS 35...		<b>TMC 1 F1 100 0.2A</b>	<b>0914015</b>	6

### TMC type key

The type key indicates the unique structure of the product.

Type	Main current paths	Characteristic curve	Auxiliary contact versions	Nominal current
<b>TMC</b>	<b>1</b> ≙ Single-pos. <b>2</b> ≙ Two-pos. <b>3</b> ≙ Three-pos.	<b>F1</b> ≙ Therm. 1.05 - 1.4 $I_N$ , magn. 2 - 4 $I_N$ DC (fast-blow), <b>Only for DC applications</b> <b>M1</b> ≙ Therm. 1.05 - 1.4 $I_N$ , magn. 6 - 12 $I_N$ AC, 7.8 - 15.6 $I_N$ DC (medium-blow)	<b>100</b> ≙ Single-pos.: 1 N/O contact <b>200</b> ≙ Single-pos.: 1 N/C contact <b>120</b> ≙ Two-pos.: 1 N/O contact, 1 N/C contact <b>122</b> ≙ Three-pos.: 1 N/O contact, 2 N/C contacts	0.2 A    2.5 A 0.3 A    3 A 0.4 A    4 A 0.5 A    5 A 0.6 A    6 A 0.8 A    8 A 1 A      10 A 1.5 A    12 A 2 A      16 A

### Ordering example:

TMC with single-pos. main current path, one N/O contact, medium-blow characteristic curve, and a nominal current of 2 A.

TMC	1	M1	100	2 A
-----	---	----	-----	-----

# Device circuit breakers

## Single-channel device circuit breakers

### TCP thermal circuit breaker

- The pluggable thermal miniature circuit-breaker combines the protective mechanism of an automotive flat-type fuse with the advantages of a circuit-breaker
- In the event of an error, the time-sensitive search for a suitable replacement fuse is eliminated thanks to the reclosure function
- The area of application extends to the protection of integrated circuits in all battery and onboard systems with up to 32 V DC
- Fits in all fuse holders designed for flat-type fuse-links according to ISO 8820-3 (DIN 72581-3)
- A version with screw or spring-cage connection is used as a basic terminal block

<b>Notes:</b>
1) If the fuse is faulty, the downstream circuit is not off load.
Attention: The reset button must not be obstructed. During installation, please leave enough room for using button.
For further technical data, drawings, and accessories, and a complete data sheet, please visit <a href="http://phoenixcontact.net/products">phoenixcontact.net/products</a> .
You can find a wide selection of fuse terminal blocks in Catalog 1

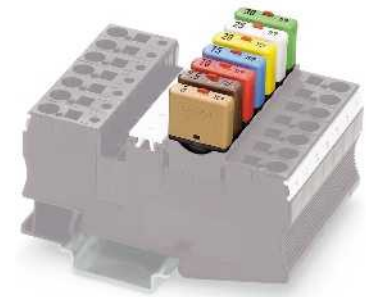

For fuse holder

<b>Electrical data</b>
Rated voltage
Nominal current $I_N$
<b>Disconnection</b>
Switch-off time
Fuse type
Rated short-circuit switching capacity $I_{cn}$
<b>General data</b>
Dimensions W/H/D
Height
Ambient temperature (operation)
Degree of protection

#### ERC

Total width 6 mm

Technical data		
IEC	UL / CUL	CSA
32 V DC	-	-
Depends on the product version selected		

See tripping characteristic  
Slow-blow  
 $\leq 50$  A (300 switch-offs)

6 mm / 20.3 mm / 24 mm  
17 mm  
-40 °C ... 85 °C  
IP30 (Actuation area)

Ordering data		
Type	Order No.	Pcs./Pkt.
TCP 5/DC32V	0700005	50
TCP 7,5/DC32V	0700007	50
TCP 10/DC32V	0700010	50
TCP 15/DC32V	0700015	50
TCP 20/DC32V	0700020	50
TCP 25/DC32V	0700025	50
TCP 30/DC32V	0700030	50
TCP 40/DC32V	0700040	50

Description	Nominal current
<b>One-pos., thermal circuit breaker</b> , for fuse holders in acc. with ISO 8820-3	
	5 A
	7,5 A
	10 A
	15 A
	20 A
	25 A
	30 A
	40 A

Accessories		
Type	Order No.	Pcs./Pkt.
ST 4-FSI/C	3036372	50
ST 4-FSI/C-LED 12	3036495	50
ST 4-FSI/C-LED 24	3036505	50
UK 6-FSI/C	3118203	50
UK 6-FSI/C-LED12	3001925	50
UK 6-FSI/C-LED24	3001938	50
PT 6-FSI/C	3212166	50
PT 6-FSI/C-LED 12	3212169	50
PT 6-FSI/C-LED 24	3212172	50
PT 6-FSI/C-LED 48	3212175	50

<b>Fuse terminal block</b> , with spring-cage connection, for mounting on NS 35...
with LED display for 12 V DC, 1.7 mA <sup>1)</sup>
with LED display for 24 V DC, 1.9 mA <sup>1)</sup>
<b>Fuse terminal block</b> , with screw connection, for mounting on NS 32... or NS 35...
with LED display for 12 V DC, 1.7 mA <sup>1)</sup>
with LED display for 24 V DC, 1.9 mA <sup>1)</sup>
<b>Fuse terminal block</b> , with Push-in connection, for mounting on NS 35...
with LED display for 6 - 12 V DC, 0.31 - 0.95 mA
with LED display for 12 - 30 V DC, 0.31 - 0.95 mA
with LED display for 24 - 48 V DC, 0.31 - 0.95 mA

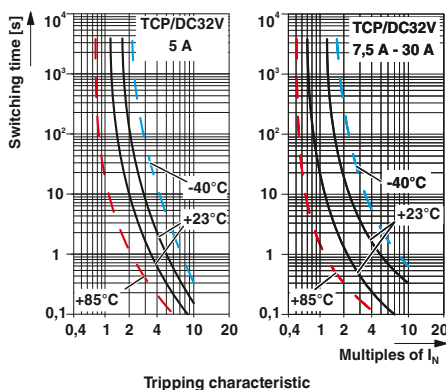

**TCP thermal circuit breaker**

- The reclosable thermal circuit breaker is available in nine nominal current levels ranging from 0.25 to 10 A
- The integrated switching function enables immediate reclosure and thus ensures the availability of the system
- Compact design
- A version with screw or spring-cage connection is used as a basic terminal block
- Potential distribution possible by means of bridges

**Notes:**  
 When mounted in rows, the nominal device current can be limited to just 80% or must be oversized accordingly.  
 For further technical data, drawings, and accessories, and a complete data sheet, please visit [phoenixcontact.net/products](http://phoenixcontact.net/products).



Can be plugged into a fuse terminal block

CE, RoHS, ENEC, UL  
 Total width 8.2 mm

Electrical data	
Rated voltage	250 V AC
Rated voltage	65 V DC
Nominal current $I_N$	Depends on the product version selected
Disconnection	
Switch-off time	See tripping characteristic
Fuse type	Slow-blow
Rated short-circuit switching capacity $I_{cn}$	-
General data	
Dimensions W/H/D	8.2 mm / 64 mm / 88.5 mm
Ambient temperature (operation)	-20 °C ... 60 °C
Degree of protection	IP40 (Actuation area)

Technical data		
IEC	UL / CUL	CSA
250 V AC	-	-
65 V DC	-	-
Depends on the product version selected		
See tripping characteristic		
Slow-blow		
-		
8.2 mm / 64 mm / 88.5 mm		
-20 °C ... 60 °C		
IP40 (Actuation area)		

Description	Nominal current
<b>Thermal miniature circuit breaker</b> , can be plugged into UK 6 FSI/C or ST 4-FSI/C fuse terminal block	
	0.1 A
	0.25 A
	0.5 A
	1 A
	2 A
	3 A
	4 A
	6 A
	8 A
	10 A

Ordering data		
Type	Order No.	Pcs./Pkt.
TCP 0.1A	0712107	20
TCP 0.25A	0712123	20
TCP 0.5A	0712152	20
TCP 1A	0712194	20
TCP 2A	0712217	20
TCP 3A	0712233	20
TCP 4A	0712259	20
TCP 6A	0712275	20
TCP 8A	0712291	20
TCP 10A	0712314	20

Accessories	
Fuse terminal block, for mounting on NS 32... or NS 35...	
Fuse terminal block, for flat-type fuses	
Lateral groove marking	

UK 6-FSI/C	3118203	50
ST 4-FSI/C	3036372	50
For ZB 5, see page 197		

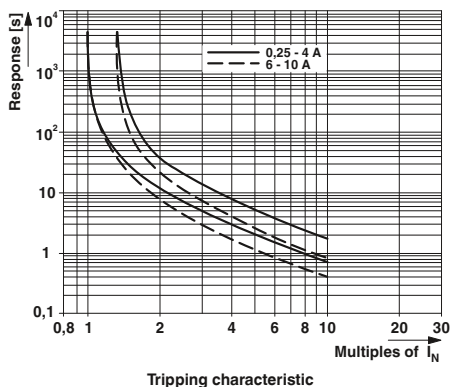

### Installation notes for surge protective devices

#### Installation direction:

Surge protective devices with a multi-stage configuration which are looped into the circuit are marked “IN” or “unprotected” and “OUT” or “protected”. They must be connected before the device to be protected so that “IN” / “unprotected” points towards the direction from which the surge voltage is expected.

The device to be protected should be connected to the terminal points marked “OUT” / “protected”. This is the only way to ensure correct operation of the surge protective device in the event of a surge voltage coupling.

#### Connection:

The protective conductor connection of the system to be protected should be connected directly and via the shortest route to the ground connection of the surge protective device or the corresponding connection terminal block on the “OUT” / “protected” side of the surge protective device.

This is the only way to ensure that impermissibly high voltages due to potential increases caused by discharge currents are prevented between the ground connections of the surge protective device and the device to be protected. The same is true for the connection between ground and the live conductors of the device to be protected (see figure: ground connection).

#### Equipotential bonding:

Correct operation of the surge protective devices requires complete equipotential bonding in accordance with the applicable regulations.

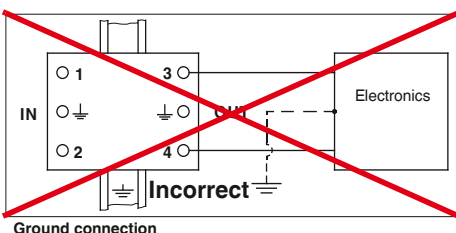
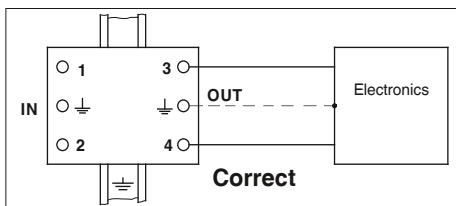

#### Cable routing:

Protected and unprotected cables must not be laid directly parallel to one another. They must be physically separated or shielded from one another so that surge voltages cannot be coupled from unprotected cables to protected ones. If crossed, cables that can influence one another must be crossed at right angles.

#### Quenching follow currents:

Gas-filled surge arresters only have limited self-quenching capability and are therefore almost always suitable for protecting message transmission systems.

The arresters easily meet the requirements of the usually high-impedance remote indication circuits. Distinct quenching behavior is observed under the following conditions in the case of systems with higher operating voltage or lower impedance:

**AC application:** if the possible short-circuit current of the source exceeds the alternating current carrying capacity, a fuse is required to prevent overheating caused by the follow current.

**DC application:** for voltages > 12 V DC, the possible short-circuit current of the source must not exceed 100 mA. Otherwise a fuse that enables shutdown within 5 seconds should be selected. Self-quenching capability is ensured for voltages ≤ 12 V. Please note, however, that the specific technical data for the product must always be observed.

**Backup fuse:** the system must be protected against impermissibly high short-circuit currents due to arrester overload. The maximum permissible or required backup fuse for the affected arrester is documented in the technical data of the relevant product.

### Surge voltage limiting components

The main function-specific components for lightning current arresters and surge protective devices are spark gaps, gas-filled surge arresters, varistors, and diodes, as well as decoupling impedances.

All components have specific advantages and disadvantages. In order to achieve optimum protection, protective circuits and multi-stage protection concepts that combine various components can be implemented.

#### Suppressor diode

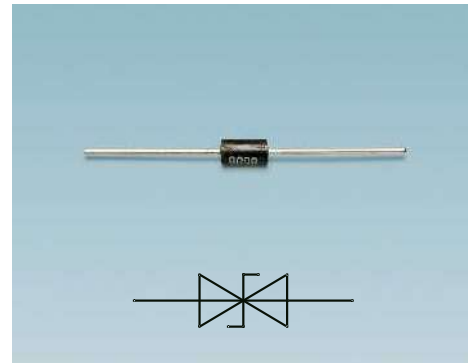

The reverse voltage  $U_R$  is the highest voltage that the diode can safely block. A current of 1 mA flows through the suppressor diode at the breakdown voltage  $U_B$ . At this point the suppressor diode starts limiting the surge voltage.

The maximum clamping voltage  $U_C$  is the highest voltage which can be present at the suppressor diode in the event of a peak pulse current  $I_{pp}$  (10/1000)  $\mu$ s.

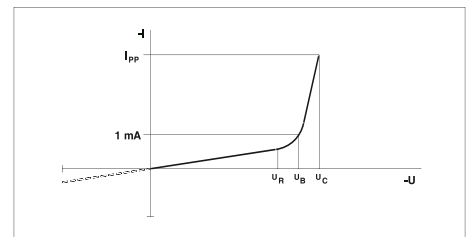

U/I characteristic curve of a suppressor diode

Explanation:

- $U_R$  = Reverse voltage
- $U_B$  = Breakdown voltage
- $U_C$  = Clamping voltage
- $I_{pp}$  = Peak pulse current
- $I_R$  = Reverse current

**Varistors**

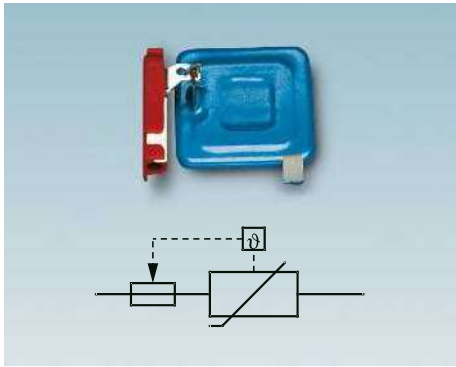

Block varistor with thermal disconnect device

Varistors are “voltage-dependent resistors” which, due to their voltage/current characteristic curves enable a high discharge capacity with a low residual voltage.

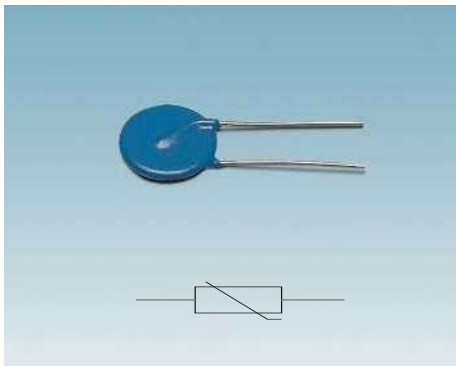

Disc varistor

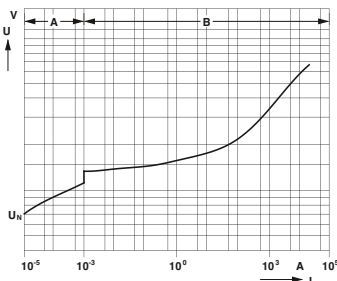

U/I characteristic curve of metal oxide varistors

Explanation:

- A = High-resistance operating area
- B = Low-resistance operating area/limiting area

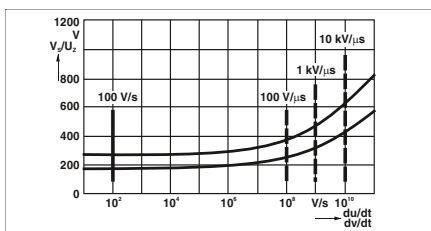

Characteristic ignition curve of a gas-filled surge arrester

- Static response behavior
- Dynamic response behavior

**Gas-filled surge arresters**

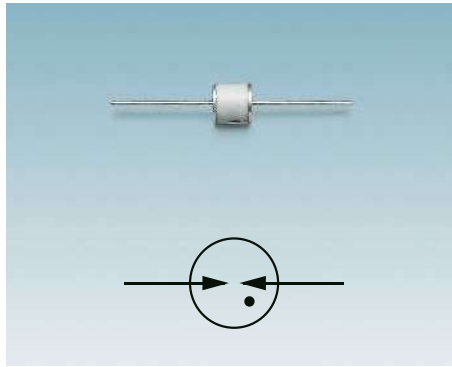

Gas-filled surge arresters consist of an electrode arrangement in a ceramic or glass tube. Between the electrodes is an inert gas, such as argon or neon. When the igniting voltage is reached, the component changes to a low-resistance state as a result of the gas discharge used. The igniting voltage is not a constant, instead it is dependent on the rate of rise of the surge voltage.

After igniting the discharge path, an arc voltage between 10 and 30 V typically occurs, which can be measured as a voltage drop at the arrester. In this low-resistance state, a line follow current, whose value depends on the impedance of the mains connected upstream, can flow through the arrester. In order to interrupt line follow currents that exceed the self-quenching capability, a fuse must be connected upstream of the surge arrester. Series connection of varistors or resistors is also possible.

The ArC spark gap in the FLASHTRAB lightning current arrester is based on arc chopping technology. Two spark horns positioned opposite one another are kept at a distance by an isolator bridge bar. In addition, a baffle plate is fitted below the electrodes in the direction of the opening. In the event of a surge voltage, surface discharge occurs along the isolator bridge bar, which creates an arc. This is driven along the spark horns towards the baffle plate where it is chopped up. The resulting physical effects quench the arc and the associated line follow currents.

A significant increase in the follow current quenching capacity can be achieved with spark gap types in which quenching plates are arranged around the spark horns.

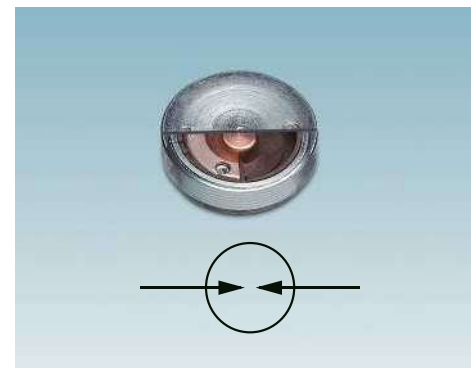

Encapsulated ArC spark gap

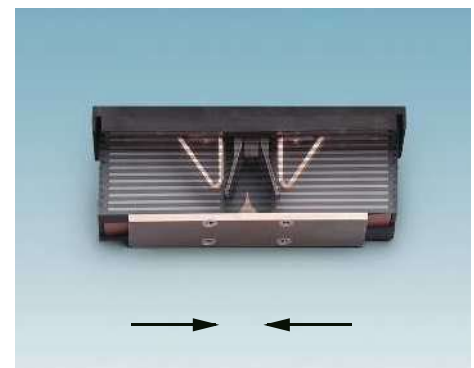

ArC spark gap with quenching plates

**Spark gaps**

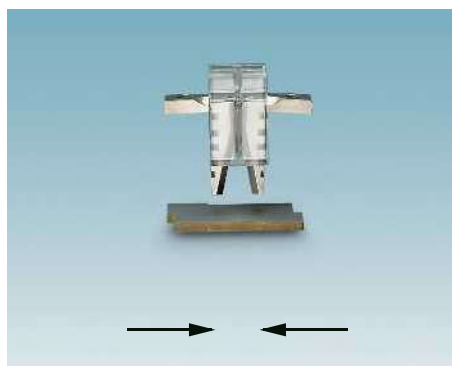

ArC spark gap

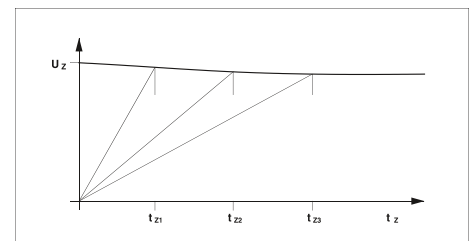

Characteristic ignition curve of a spark gap

### Surge protective devices

The wide range of different applications also requires numerous different surge protective devices with application-specific properties. Important criteria include the type of circuit, the surge-voltage limiting properties, and the design. The TRABTECH range from Phoenix Contact offers numerous versions, such as adapters, junction boxes or DIN-rail-mountable arresters in a modular and compact design, providing practical system solutions for all applications.

In line with their intended application, surge protective devices are designed for high electrical loads. However, excessive or very frequent surge voltages may lead to overload. This can result in a reduction or even failure of the protective function, and the affected protective device having to be replaced. Where possible, surge protective devices should therefore have a pluggable design and support testing.

The TRABTECH product range from Phoenix Contact takes these requirements into consideration as far as modern technology permits. The product range includes surge protective devices in the form of adapters, as well as devices with a two-piece pluggable modular design.

The protective devices in the FLASHTRAB, VALVETRAB, PLUGTRAB, and COMTRAB product ranges are particularly interesting with regard to their plug-in capability and testability. They have been developed with various protective circuits and different nominal voltages for applications in power supply, measurement and control, and data interface protection.

With components that are perfectly designed to work together, i.e., gas-filled surge arresters, varistors, and suppressor diodes depending on the protective circuit, their specific advantages are fully utilized.

### Explanation of terms

#### AC withstand voltage

The r.m.s. value of the highest sinusoidal voltage at mains frequency which will not lead to a disruptive discharge under the specified test conditions.

#### Aging

Modification of the original performance data due to disturbing pulses, operation or unfavorable ambient conditions.

#### Ambient conditions

The immediate ambient conditions for the device or the relevant air and creepage distances.

#### Arc voltage $U_{\text{a}}$

The arc voltage is the instantaneous value of the voltage on a discharge path (arc discharge) during an arresting process.

#### Arrester

Item of equipment that mainly consists of voltage-dependent resistors and/or spark gaps. Both elements can be connected in series or in parallel, or even used individually. Arresters are used to protect other electrical equipment and electrical systems against impermissibly high surge voltages.

#### Associated electrical equipment

An item of electrical equipment in which not all circuits are intrinsically safe, but which contains circuits that can influence the safety of the intrinsically safe circuits to which they are connected.

#### Asymmetrical interference

Asymmetrical means that the source of interference and the potentially susceptible equipment are grounded, i.e., they have a capacitive or galvanic connection to the protective conductor. As shown in the figure, the interference moves from the source along both conductors to the potentially susceptible equipment and back via ground. The terms "common-mode interference" or "common mode" are also used.

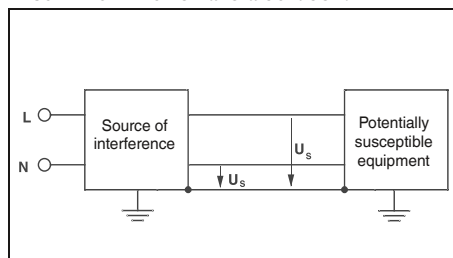

#### Asymmetrical voltage, common mode voltage

Average voltage between each conductor and a specified reference point, usually reference ground or ground.

#### Burst

Pulses which occur repeatedly within a specific time interval.

#### Common mode voltage

The common mode voltage is the voltage which occurs in the event of interference between live conductors and ground.

#### Coupling

Interaction between circuits, in which energy is transferred capacitively, inductively or galvanically from one circuit to the other.

#### Direct or close-up strikes

These cause surge voltages with an energy level that constitutes a considerable part of the total energy of the lightning discharge.

#### Discharge of static electricity; electrostatic discharge; ESD

The transmission of an electrical charge between bodies with different electrostatic potentials when they are in close proximity or touching.

#### Disconnect device

This is a device which disconnects a SPD from the mains when it fails. It is designed to prevent a permanent fault in the system caused by the faulty surge protective device and provide an optical indication of the faulty SPD.

#### Disturbance variable

The disturbance variable is an electromagnetic (or electrical or magnetic) variable, which can have an undesirable influence on electrical equipment.

#### Electromagnetic compatibility (EMC)

The ability of a device or system to operate without faults in an electromagnetic environment without itself causing electromagnetic interference, which would be unacceptable for other devices in this environment.

#### Electromagnetic environment

The sum of all electromagnetic phenomena at a given location.

### Electromagnetic interference

A loss in the quality of the operating behavior, such as malfunction or failure of electrical or electronic equipment, that is caused by an electromagnetic disturbance variable.

### Equipment to be protected

All equipment of a structural system or a range which requires surge protection or lightning protection.

### Equipotential bonding

The removal of potential differences between conductive parts, in which all points assume virtually the same potential.

A distinction is made between functional equipotential bonding and protective equipotential bonding.

### Equipotential bonding conductors

These are electrically conductive connections used to create equipotential bonding.

### Equipotential bonding strip

This is the strip which is designed to connect protective conductors, equipotential bonding conductors, and conductors for functional earth grounding to the ground conductor and the ground electrodes.

### Equipotential bonding system

This refers to all the interconnected equipotential bonding conductors, including the conductive parts such as housing or external conductive parts which work in the same way.

The equipotential bonding system can also be the grounding system or part of a grounding system.

### Exposure

Exposure is an insufficient distance between the lightning protection system and metal installations or electrical systems which leads to a risk of flashover or disruptive discharge in the event of a lightning strike.

### Exposure voltage

The exposure voltage is a voltage that occurs at the exposure point when lightning strikes the lightning protection system.

### Follow current $I_f$

Current which flows through the SPD following discharge and is supplied by the mains. The follow current differs considerably from the continuous operating current.

### Gas-filled surge arrester

The gas-filled surge arrester is a discharge path which is filled with a gas other than air, generally an inert gas.

### Ground

This expression refers to the earth and the ground.

### Ground conductor

A conductor which connects the equipment to be grounded to a ground electrode, as long as the ground conductor is not laid in the ground or, if laid in the ground, is insulated.

### Ground electrode

A conductor embedded in the ground with an electrically conductive connection to ground. Parts of supply lines to a ground electrode, which are not insulated in the ground, are considered to be parts of the ground electrode.

### Grounding

Grounding is the sum of all means and measures used for grounding.

### Grounding resistance

The resistance between the grounding system and the reference ground. The amount of grounding resistance depends on the interaction of the individual ground electrodes.

### Impulse sparkover voltage of 1.2/50 $\mu$ s

Highest voltage value before the disruptive discharge between the electrodes of the spark gap of a SPD.

### Impulse withstand voltage $U_{st}$

The peak value of the highest surge voltage with a predefined form and polarity, which will not lead to a disruptive discharge under the specified test conditions.

Note: the impulse withstand voltage is equal to or greater than the rated surge voltage.

### Inactive parts

Inactive parts are conductive parts that are electrically isolated from all live parts through basic insulation.

### Insertion attenuation

To determine the insertion attenuation of a SPD, the mains and frequency are specified. The attenuation value is defined as the ratio of voltages that occur immediately before and after the insertion point of the SPD to be tested. The result is expressed in decibels.

### Insulation coordination

The assignment of characteristic insulation data for an item of equipment for:

- Expected surge voltages
- Characteristic data of the surge protective device
- Expected ambient conditions
- Protective measures against contamination

### Interference suppression

Measure to reduce or avoid the electromagnetic disturbance variables that occur.

### Intrinsically safe circuit

A circuit protected against sparks and thermal effects that may occur under the conditions specified in DIN EN 60079-11 (which include error-free operation and specific fault conditions), which can cause the ignition of a particular explosive gas atmosphere.

### Intrinsically safe electrical equipment

Electrical equipment in which all circuits are intrinsically safe.

### Lightning protection system

All devices as a whole that provide external and internal lightning protection for the system to be protected.

### Lightning surge current $I_{imp}$

Lightning surge currents are characterized by the parameters peak value, charge, specific energy, and current rate of rise. The lightning surge current  $I_{imp}$  is a measurement for the discharge capacity of lightning current arresters (class I). It is determined according to a defined test procedure using 10/350  $\mu$ s waveform test pulses.

### Lightning surge voltage

Surge voltage as a result of lightning discharge.

### Lightning test current

The (10/350)  $\mu\text{s}$  lightning test current has a rise time of 10  $\mu\text{s}$  and a decay time to half-value of 350  $\mu\text{s}$ .

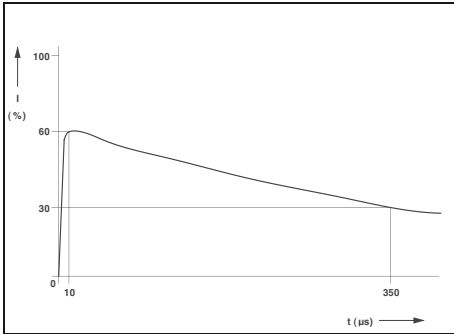

10/350 lightning current pulse according to IEC 62305-1

### Live parts

Live parts are conductors and conductive parts of equipment that are energized under normal operating conditions.

### Maximum continuous voltage $U_c$

The rated voltage is the maximum permissible r.m.s. value of the power-frequency AC voltage, which may be permanently applied to the protective paths of the arrester.

### Nominal current $I_N$ or load current $I_L$

Highest continuous current for products according to IEC 61643 which can flow through the surge protective device at the specified temperature without altering the electrical operating properties. For higher operating temperatures, the nominal current is lower (derating).

### Nominal discharge surge current $I_n$

Peak value of the current flowing through the SPD with surge form (8/20)  $\mu\text{s}$ . It is used to classify the SPD according to class II. Source: EN 61643-11

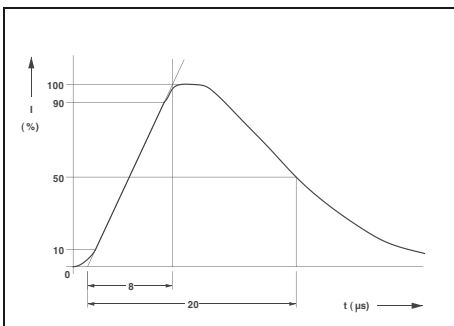

8/20 surge current pulse according to IEC 60060-1

### Nominal voltage $U_N$

A suitable rounded voltage value, which is specified by the manufacturer for equipment for the purpose of designation or identification.

### Normal mode voltage

The normal mode voltage is the voltage which occurs in the event of interference between two conductors of a circuit.

### Potentially susceptible equipment

All electrical equipment whose function can be influenced by disturbance variables is referred to as potentially susceptible equipment. Influence on function may be in the form of a functional disturbance, reduction in function, malfunction or failure.

### Protection level $U_p$

A parameter that characterizes the performance capabilities of the SPD with regard to voltage limitation via its connection terminal blocks. This value, which should be specified by the manufacturer, must be greater than the highest measured value of the clamping voltages.

### Protective paths

The voltage-limiting or switching components of the SPD can be connected between conductor/ conductor, conductor/ground, conductor/neutral conductor, and neutral conductor/ground or a combination of these options. These circuit types are referred to as protective paths.

### Pulse

Rapid, brief alteration of a physical variable, followed by a fast return to the original value.

### Pulse burst; burst

Result of a limited number of pulses or waves of a limited duration.

### Rate of rise

Average rate of change of a variable between two specified values, e.g., 10% and 90% of the peak value.

### Reference ground

An area of the earth, particularly of the earth's surface, which is so far away from the ground conductors that no noticeable voltages occur between any points of this area as a result of the current entering the earth.

### Remote strikes

These usually cause surge voltages with a significantly lower energy level than close-up strikes. Remote strikes are responsible for causing surge voltages in electrical and electronic systems.

### Residual current device (RCD)

Residual current devices are devices which isolate electrical systems from the power supply system as soon as the residual current to ground exceeds a specific value.

### Residual voltage $U_{res}$

The peak voltage value that occurs while discharge surge current is flowing via the terminal blocks of the SPD.

Source: EN 61643-11:2002

### Response

- A response is when either:
- The peak value of the ohmic components of the current flowing through the arrester reaches 5 mA
  - A voltage dip with an increase in the peak value of the current flowing through the arrester to 5 mA occurs

### Selective residual current device

Selective residual current devices are time-delayed circuit breakers.

### Short-circuit stability

Highest interference-free short-circuit current the SPD can withstand.

### Source of interference

A source of interference is the origin of disturbance variables. In principle, any electrical equipment, such as motors or fluorescent lamps, can be a source of interference.

### Specialist

A specialist is a person who, because of their education, experience, and instruction, and their knowledge of relevant regulations, can assess any required operations and recognize any possible dangers.

Note: when considering a person's professional training, several years' experience in the relevant field can also be taken into account.

### Spike

A relatively short single-polarity pulse.

### Surface discharge surge arrester

The surface discharge surge arrester, according to DIN VDE 0845 Part 1, is a discharge path in which gas discharge is initiated by means of surface discharge.

### Surge current of (8/20) $\mu\text{s}$

Surge current with a rise time of 8  $\mu\text{s}$  and a decay time to half-value of 20  $\mu\text{s}$ . Source: IEC 60060-1

**Surge current of (10/350)  $\mu$ s**

Surge current with a rise time of 10  $\mu$ s and a decay time to half-value of 350  $\mu$ s. Source: IEC 62305-1

**Surge protection equipment (SPE)**

Surge protection equipment consists of surge protective devices and all equipment in telecommunications systems, including their cables, used for surge protection.

**Surge protective device (SPD)**

A device to limit surge voltages and discharge surge currents. It contains at least one non-linear voltage-limiting component.

**Surge voltage**

Any voltage with a peak value that exceeds the corresponding peak value of the maximum continuous voltage under normal operating conditions. Source: EN 60664-1

**Surge voltage category**

Assignment of electrical equipment to the anticipated surge voltage.

**Surge voltage of (1.2/50)  $\mu$ s**

Surge voltage with a rise time of 1.2  $\mu$ s and a decay time to half-value of 50  $\mu$ s. Source: IEC 60060-1

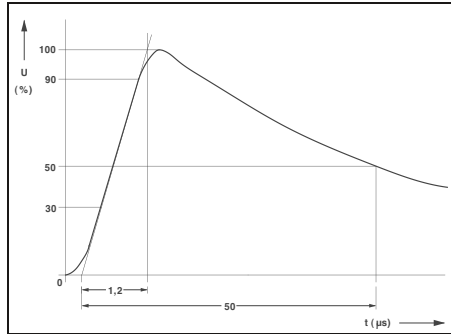

1.2/50 surge voltage pulse according to IEC 60060-1

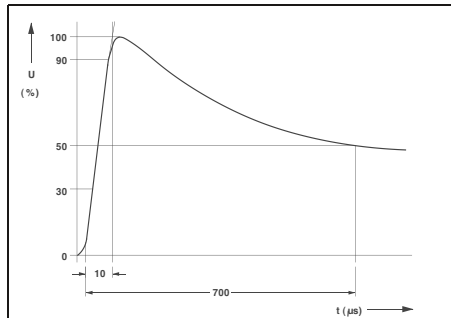

10/700 surge voltage pulse according to ITU-T K.44

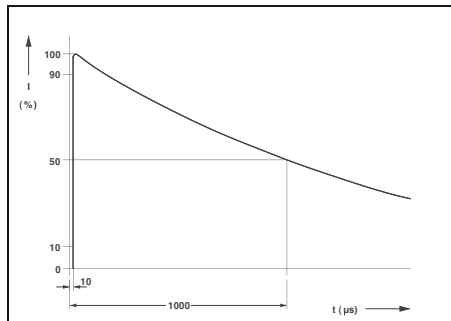

10/1000 surge current pulse according to IEEE C62.41.1

**Switching surge voltage**

Surge voltage as a result of a switching operation.

**Symmetrical interference**

As shown in the figure, the disturbance variable moves from the source along one conductor to the potentially susceptible equipment and back along the other conductor. The terms “normal-mode interference” or “differential mode” are also used.

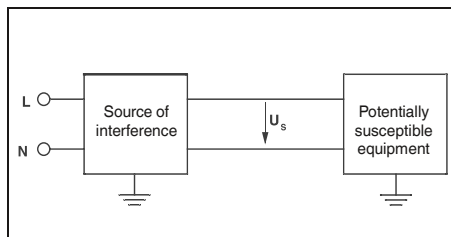

**Symmetrical interference voltage**

Interference voltage between two wires of a cable (e.g., double cable) or between two connection points of electrical equipment for this cable type.

**Symmetrical voltage, differential mode voltage**

Voltage between two live conductors from one defined group.

**Temperature range**

Range between the minimum and maximum temperature that may be present at/in housing. For devices without self-heating, this value is the permissible ambient temperature. For devices with self-heating, these values are the maximum temperatures that may occur at/in the device during operation.

**To ground**

An electrically conductive part, e.g., the lightning protection system is connected to ground via a grounding system.

**Transient**

Describes a phenomenon or variable which changes during what is, in comparison to the time scale being observed, a short period of time between two consecutive stationary states.

**Transients**

Irregular and relatively short positive and/or negative voltage or current changes between two stationary states.

**Varistors**

A varistor is a bipolar non-linear resistor with a symmetrical voltage/current characteristic curve and a resistance value which decreases as the voltage increases.

Quality in quantity

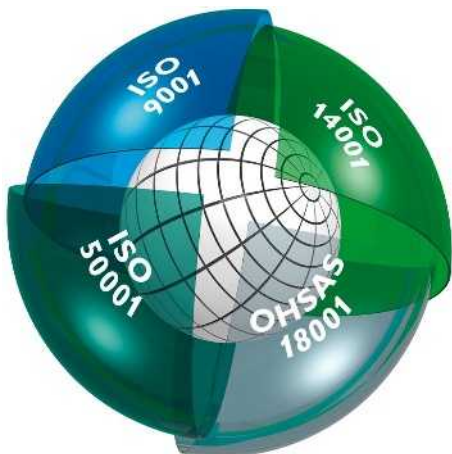

**Integrated management system**

The objective of the Phoenix Contact integrated management system is to integrate all requirements pertaining to products, processes, and the organization.

Statutory and regulatory requirements, as well as those of international standards and our customers, are met and, in some cases, even exceeded in all phases of the product lifecycle.

The Phoenix Contact management system is monitored by internationally recognized independent bodies each year to ensure that quality, environmental protection, energy efficiency, and occupational safety have been integrated in conformance with the relevant requirements. Certification in accordance with international standards ISO 9001, ISO 14001, ISO 50001, and BS OHSAS 18001 is the result of our corporate philosophy of meeting the needs of our customers, staff, and environment as best as possible. They serve as the basis for innovative products with the familiar high Phoenix quality standard, actively practiced environmental protection through efficient production and products that conserve resources, and responsibility in the field of occupational health and safety. It goes without saying that we integrate all further requirements of standards, international approvals or special customer requirements into our company processes.

The result of this system is a building block for the success of the Phoenix Contact Group as well as its products and services.

**CE marking**

CE marking was introduced as an important instrument for the free movement of goods within the European single market. By applying the mark to a product, the manufacturer confirms its compliance with all EU directives applicable to this product. The EU directives describe the product characteristics with regard to device safety and the avoidance of risks. These are legally binding regulations of the European Union (EU), which means that the fulfillment of these requirements is a **legal prerequisite**

**for the marketing of these products within the EU.**

Where applicable, our products currently fall within the scope of the following directives:

- 2014/35/EU  
Electrical equipment designed for use within certain voltage limits (Low Voltage Directive)
- 2014/30/EU  
Electromagnetic compatibility (EMC Directive)
- 2014/32/EU  
Measuring instruments
- 2006/42/EC  
Safety of machinery (Machinery Directive)
- 2014/34/EU  
Equipment and protective systems intended for use in potentially explosive atmospheres (ATEX Directive)
- 1999/5/EC  
Radio Equipment and Telecommunications Terminal Equipment Directive (R&TTE)
- 2014/53/EU  
Radio equipment (RED)
- 2011/65/EU  
RoHS Directive

The standards used as the basis for the aforementioned directives have been at the heart of our development standard for some time as a way of ensuring compliance with European directives. The numbers of the directives indicate their version at the time of publication. In the event of changes to directives and/or standards, our products will undergo conformity assessment again in good time and a new declaration of conformity will be issued promptly. The current declarations for each product can also be found in our download area.

Among the aforementioned European directives, the EMC Directive plays a particularly important role. It uses a legally binding directive as the basis for defining electromagnetic compatibility as a fundamental device property. European legislation therefore places great emphasis on the electromagnetic compatibility of devices and systems as a basic prerequisite for the error-free operation of machines and systems. As an international leader in the field of surge protection, Phoenix Contact has extensive expertise in EMC. This expertise and the experience gained over many years in the development and application of industrial interface and communication technology have resulted in an extremely high standard of quality for our products when it comes to electromagnetic compatibility. Our sister company, Phoenix Testlab, was founded in order to share this expertise with other companies. Phoenix Testlab GmbH is an independent, accredited service company, which carries out EMC testing in compliance with the European standards. At Phoenix

Testlab, devices are also tested with regard to their electrical safety, mechanical influences, and their behavior in relation to environmental influences. Phoenix Testlab is also a notified body according to EMC Directive 2014/30/EU, R&TTE Directive 1999/5/EC for radio equipment and telecommunications terminal equipment, and Radio Equipment Directive (RED) 2014/53/EU. As a certification body (TCB, FCB, and RCB), Phoenix Testlab is also able to approve these products for the markets in the USA, Canada, and Japan.

**Standards and regulations**

All relevant standards and regulations are used as the basis for the development and maintenance of our products.

International standards are subject to continuous changes as a result of harmonization and new developments. In line with this process, the current version of all standards that are relevant to our products is documented in the product area on our website at

**[phoenixcontact.net/products](http://phoenixcontact.net/products)**.

**Online product information service on the world wide web**

Phoenix Contact is continuously extending its product range.

Within the scope of our product monitoring obligation, all products are subject to an improvement process.

The Internet is an ideal platform to quickly communicate new product developments and improvements to the market.

You can quickly access the relevant Phoenix Contact website for your region via [phoenixcontact.com](http://phoenixcontact.com). There you will always find an up-to-date overview of products, solutions, and services from Phoenix Contact. This includes technical documents such as data sheets and user manuals, current driver and demo software, and a direct link to the relevant contact person.

## Touch proofness

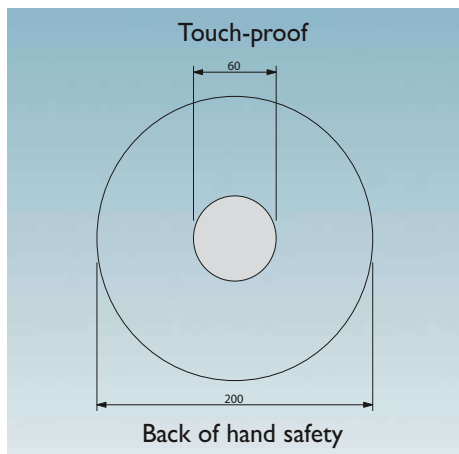

Example: pressure actuation

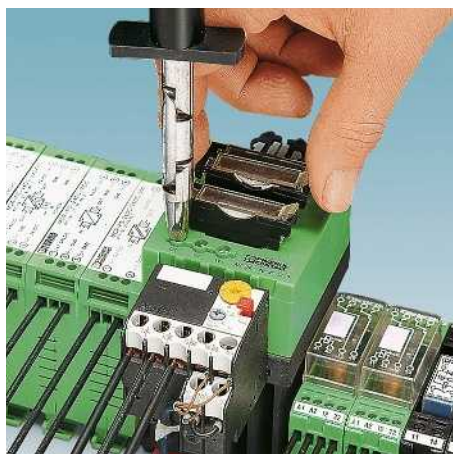

Finger safety



Back of hand safety

The accident prevention regulations BGV A 2 issued by the German employer's liability insurance association for precision mechanics and electrical engineering apply to the operators of electrical systems and are aimed at the prevention of electrical accidents by means of special safety requirements.

These regulations contain specifications regarding the safety distances for work, operation, and occasional handling in the proximity of "live parts" in low-voltage systems up to 1000 V ~ or 1500 V –.

- Work with live parts is only permitted once they have been de-energized.

Operational activities are only permitted in the vicinity of live parts if these parts are de-energized or are protected against direct contact (§ 6). The following safety measures apply when working in the vicinity of live parts:

- Provision of the de-energized state for the duration of the work
- Ensure shock protection is in place in the form of covers or barriers during the work
- Assurance that proximity limits will not be violated (§ 7)

The term "occasional handling" has been introduced for the operation of elements such as pushbuttons, rocker arms or rotary buttons in the proximity of live parts.

In VDE 0105-1, this is covered by "operation with partial protection against direct contact".

Detailed specifications for "occasional handling" can be found in DIN VDE 0106-100. This specifies to what degree live parts in the proximity of operating elements are to be protected against contact. The basis for this is the definition of a "protection area for occasional handling"; this is the area into which the user must reach in order to

handle the machine.

The most important thing is that an area formed by an even envelope curve 30 mm in radius must surround the live parts. This area must be **touch-proof**, i.e., the live parts of the electrical device must not be within reach of the VDE test finger according to IEC 60529/DIN VDE 0470-1 (test finger).

Back of hand safety is specified for the "rest of the area" up to 100 mm around the operating element. **Back of hand safety** means that when a force of 50 N is applied to a ball with a diameter of 50 mm, this does not come into contact with the live parts of the equipment. No special measures for ensuring contact safety are stipulated outside this area.

Note: Systems and equipment that are operated with SELV up to 25 V ~ or 60 V – are considered to be protected against "direct contact".

According to § 5, Subsection 4 of the BGV A 2 regulations, there is no need to test the condition of the system prior to initial startup if the company has confirmation from the manufacturer or installer that the electrical systems and equipment conform to BGV A 2. The confirmation required relates to systems and equipment that have been installed and are ready for operation and can only be issued by the installer or installation company. The manufacturer of the electrical equipment can only issue a confirmation that products have been produced in accordance with the relevant electrotechnical DIN VDE regulations stipulated in BGV A 2. The installer must bear this in mind when selecting the equipment to be used.

In the field of connection technology, Phoenix Contact offers a wide range of products which are touch-proof or can be

protected against contact by means of covers. Depending on the conditions, all of this must be taken into account when selecting the individual types of terminal blocks and accessories.

## Quality features of insulating housings

### Thermoplastics

The majority of our insulating housing is made from thermoplastic materials. Roughly speaking, these can be divided into amorphous and semi-crystalline substances. Thermoplastics are processed using the efficient and environmentally-friendly injection molding process. They have good recycling properties and can be re-used. We use many materials that are modified in different ways to meet the demanding requirements that electrical and electronic modules, devices, and systems have to meet with regard to their mechanical, thermal, and electrical properties.

### Behavior of plastics under the influence of temperature (operating temperatures, mechanical influences)

All plastics undergo a process referred to as thermal aging when they are subjected to heat over long periods. This process causes changes in the mechanical and electrical properties of the material. External influences, e.g., radiation, additional mechanical, chemical or electrical stresses, amplify this effect. Special tests on samples can yield characteristic data which provides a good means of drawing comparisons between different plastics. However, applying these characteristics to an evaluation of molded plastic parts is only possible to a limited extent, and can only give the designer a rough guide when it comes to selecting a plastic material. This catalog uses the following assessment criteria: the **RTI value** according to UL746B/ANSI 746 B (elec. based on electric strength) and the **Ti value** according to IEC 60216-1 (based on a 50% reduction in tensile strength after 20,000 hours).

IEC 60947-7-1/EN 60947-7-1 specifies a permissible temperature increase of 45 K for terminal blocks under nominal load. Phoenix Contact terminal blocks fulfill this requirement.

The properties of plastics are not only affected by the influence of heat as described above; they also undergo changes as a result of cold influences. When subjected to cold as well as low levels of humidity, plastics become increasingly brittle with the result that they are no longer capable of withstanding the same mechanical loads. As the table on the right shows, the plastics concerned can be used down to a temperature of -40°C, but only without a mechanical load. As far as the products presented in the catalog are concerned, it is the ambient temperature specified in each case that is to be regarded as definitive for operation. Regardless of the plastics used, this may be subject to further restrictions (e.g., limited to -20°C) as a result of the components used or other restrictive parameters.

At very low temperatures, this means that any form of mechanical load on the plastic components must be avoided (e.g., mounting of products on/removal of products from the DIN rail, actuation of terminal points, locking/ejection of relays from bases, prizing out of jumpers, bending of cables and lines, etc.), as there is always an associated risk of damage. Unless otherwise indicated, it is recommended that you carry out the specified mounting/operational tasks in a temperature range from -10°C to +40°C.

### Inflammability characteristics of plastics (UL 94)

The inflammability tests for plastics have been defined by the Underwriters Laboratory (USA) in regulation UL 94. This applies to all areas of application, particularly in electrical engineering. A horizontal or vertical test is carried out at the test laboratory to determine the inflammability of the plastic material with a naked flame. In order of increasing flame-retardant behavior, the evaluation classes are HB, V2, V1, V0, and 5V. Test results are recorded on "yellow cards" and are published annually in the **Recognized Component Directory**.

### Thermoplastics: non-reinforced polyamide, PA

We use the modern, semi-crystalline polyamide insulation material, which has now become an essential component in electrical engineering and electronics. It has long occupied a leading position and is authorized for use by the relevant approval authorities such as the CSA, NEMKO, KEMA, PTB, SEV, UL, VDE, etc.

Polyamide has excellent electrical, mechanical, chemical, and other properties even at high operating temperatures. Brief peak temperatures of up to approximately 200°C are permitted as a result of heat aging stabilization. Depending on the type (PA 4.6, 6.6, 6.10, etc.), its melting point is in the region of 215°C to 295°C.

Polyamide absorbs moisture from its surroundings, on average 2.8%. This is not the embedded water of crystallization, however, but rather chemically bound H<sub>2</sub>O groups in the molecular structure. This makes the plastic flexible and resistant to breakage, even at temperatures as low as -40°C. PA belongs to flammability rating V2 to V0 according to UL 94.

### Thermoplastics: polyester, PBT

We use the semi-crystalline thermoplastic polyester in non-reinforced and fiberglass-reinforced variants for special applications which require increased dimensional and form stability.

Apart from the high operating temperature, the material is characterized by excellent mechanical strength and hardness. Polyester does not absorb moisture from its surroundings. Therefore, PBT is particularly suitable for strips, for example, that are soldered onto PCBs and are subsequently required to pass a burn-in test where they are subjected to the influence of heat. PBT belongs to flammability rating V2 to V0 according to UL 94.

### Thermoplastics: polycarbonate, PC

Polycarbonate combines many advantages such as rigidity, impact strength, transparency, dimensional stability, good insulation properties, and resistance to heat.

The amorphous material only absorbs moisture to a very limited degree, and is used for items such as large, rigid electronic component housings.

In its transparent form, polycarbonate is particularly suitable for use as a material for cover profiles or marking materials.

PC has good resistance properties against mineral acids, saturated aliphatic hydrocarbons, gasoline, greases, and oils.

This material is not very resistant to solvents, benzene, alkalis, acetone, and ammonia. Strain cracks may result from contact with certain chemicals.

PC belongs to flammability rating V2 to V0 according to UL 94.

### Thermoplastics: polycarbonate fiber-reinforced, PC-F

Compared to non-reinforced materials, fiber-reinforced polycarbonates feature greater rigidity, impact strength, and operating temperature. In other respects, their properties are largely identical to those of non-reinforced polycarbonate.

**Thermoplastics: ABS**

We use the thermoplastic molding compound ABS for products which must have good impact and notched impact properties in addition to high mechanical stability and rigidity. The products are resistant to chemicals and stress cracking due to their special surface quality and hardness.

The characteristic thermal properties provide good dimensional stability at both low and high temperatures. Products made from ABS can be coated with metallic surfaces, e.g., nickel.

The flammability rating of the molding compound used is HB to V0 according to UL 94.

Properties	Unit/level	Polyamide PA	Polyester PBT	Polycarbonate PC	Polycarbonate PC-F	ABS
Operating temperature RTI */**	°C	≤ 105	≤ 105	≤ 125	≤ 120	≤ 80
Minimum temperature (without mechanical load)	°C	-40	-40	-40	-40	-40
Electric strength IEC 60243-1/DIN VDE 0303-21	kV/cm	600	400	> 300		850
Resistance to creepage IEC 60112/DIN VDE 0303-1	CTI...M	550	225	175		200
	CTI...	600	225	175	175	600
Tropical and termite resistance		Good	Good	Good		
Specific contact resistance IEC 60093/VDE 0303 Part 30; IEC 60167/VDE 0303 Part 31	Ω cm	10 <sup>12</sup>	10 <sup>16</sup>	> 10 <sup>16</sup>	> 10 <sup>14</sup>	10 <sup>14</sup>
Surface resistance IEC 60093/VDE 0303 Part 30; IEC 60167/VDE 0303 Part 31	Ω	10 <sup>10</sup>	10 <sup>13</sup>	> 10 <sup>14</sup>		10 <sup>13</sup>
Flammability rating according to UL 94		V2-V0	V0	V2-V0	V0	HB-V0

\* According to UL 746 B/ANSI 746 B (elec.)

\*\* Minimum value

**Dimensions**

**Dimensions: Width/Height/Depth**



The dimensions “**Width/Height/Depth**” are defined as follows for all DIN-rail-mountable products:

- **Width**: measurement taken along the DIN rail
- **Height**: measurement taken across the DIN rail
- **Depth**: measurement taken starting from the mounting plate and including the DIN rail  
NS 35/7.5 (EN 60715)

The width, height, and depth never change, even if the products shown in this catalog happen to be photographed from two different perspectives (horizontal or vertical).

To make things easier for you, one of the two symbols shown above has been included next to each product photo:

**EMC: Class A product:**

In accordance with statutory regulations, our products are indicated with this footnote if they are intended for use in industrial environments. This means that the permitted limit values for residential applications may be exceeded in the event of conducted and emitted disturbance variables. In such cases, the operator may have to take additional safety measures in order to ensure electromagnetic compatibility in residential applications.

**Note:**

Subject to changes that serve the purpose of technical progress.

### Connection cross section

The rated cross section of terminal blocks must be specified by the manufacturer according to IEC 60947-7-1. The rated cross section is the maximum conductor cross section that can be connected in single, multi or fine-strand versions subject to specific thermal, mechanical, and electrical requirements.

The manufacturer must also specify the **rated connection capacity**, i.e., the area of connectable conductors as well as the number of conductors which can be connected simultaneously and the necessary preparation of the conductor ends. The conductors can be **solid (single or multi-**

**strand)** or flexible (**fine-strand**).

These values can be found in the product-specific technical data.

The rated connection capacity of Phoenix Contact terminal blocks usually exceeds standard requirements, which specify that it must only be possible to connect one conductor with one of the two next smallest cross sections, excluding the rated cross section (standardized for the cross section range from 0.2 to 35 mm<sup>2</sup>).

In addition, conductors with a rated cross section can usually be wired with ferrules with plastic sleeve.

Phoenix Contact terminal blocks are

designed to allow copper conductors to be connected to them untreated. "Special treatment" or the use of ferrules – both permitted according to IEC 60947-7-1 – are not required. If ferrules are nevertheless used to protect stranded conductors against splicing, the connection capacity of the stranded conductor is generally reduced by one level.

### Structure and dimensions of connecting cables

Cross section [mm <sup>2</sup> ]	Single-stranded		Multi-stranded		Fine-stranded		Gauge no. AWG	American Wire Gauge [AWG]					
	Diameter max. dimension	Number of wires	Diameter max. dimension	Number of wires (minimum number)	Diameter max. dimension	Number of wires (guide value)		Solid wires			Stranded wires		
								[Ø mm]	[circ. mils]	[mm <sup>2</sup> ]	[Ø mm]	[circ. mils]	[mm <sup>2</sup> ]
0.2	0.5	1	–	–	–	–	24	0.51	404	0.21	–	–	–
0.5	0.9	1	1.1	7	1.1	16	20	0.81	1022	0.52	0.97	1111	0.56
0.75	1.0	1	1.2	7	1.3	24	18	1.02	1620	0.82	1.16	1600	0.82
1	1.2	1	1.4	7	1.5	32	(17)	1.15	2050	1.04	–	–	–
–	–	–	–	–	–	–	16	1.29	2580	1.31	1.50	2580	1.32
1.5	1.5	1	1.7	7	1.8	30	(15)	1.45	3260	1.65	–	–	–
–	–	–	–	–	–	–	14	1.63	4110	2.08	1.85	4100	2.09
2.5	1.9	1	2.2	7	2.3	50	(13)	1.83	5180	2.63	–	–	–
–	–	–	–	–	–	–	12	2.05	6530	3.31	2.41	6500	3.32
4	2.4	1	2.7	7	2.9	56	(11)	2.30	8230	4.17	–	–	–
–	–	–	–	–	–	–	10	2.59	10380	5.26	2.95	10530	5.37
6	2.9	1	3.3	7	3.9	84	(9)	2.91	13100	6.63	–	–	–
–	–	–	–	–	–	–	8	3.26	16510	8.37	3.73	16625	8.48

### Tightening torque of terminal block screws

IEC 60947-1/EN 60947-1, modified, Table 4 specifies tightening torques for screw connections based on the screw size for electrical and mechanical type tests.

#### Extract from IEC 60947-1/EN 60947-1, Table 4

The torque according to IEC and the recommended torque for Phoenix Contact terminal blocks are specified

Thread	Head screw with slot	
	Torque	Recommended tightening torque
	[Nm]	[Nm]
M2.5 (M2.6)	0.4	0.4 - 0.5
M3	0.5	0.5 - 0.6
M3.5	0.8	0.8 - 1.0
M4	1.2	1.2 - 1.5

















































### Current carrying capacity

Standard IEC 60947-7-1/EN 60947-7-1/DIN VDE 0611-1 specifies the test currents for the individual conductor cross sections listed in the adjacent table. The corresponding currents are listed with the connection data for the individual terminal blocks. The type tests of terminal blocks are based on this data.

#### Test currents according to IEC 60947-7-1/EN 60947-7-1, Table 5

Rated cross section	[mm <sup>2</sup> ]	0.2	0.5	0.75	1.0	1.5	2.5	4	6	10	16
Test current	[A]	4	6	9	13.5	17.5	24	32	41	57	76

### Certification bodies and safety marks

Certification bodies and approvals	Country code	Explosion protection	Country code	Marine classification societies	Country code
 IECCE CB Scheme (in combination with certifying body)	International	 International Electrotechnical Commission	International	 DNV GL - MARITIME	DE
 CENELEC Certification Agreement (CCA inspection report) (in combination with certifying body)	EU	 ATEX Directive	EU	 Bureau Veritas	FR
 Canadian Standards Association (CSA)	CA	 DEKRA Certification B.V.	NL	 Germanischer Lloyd AG	DE
 Canadian Standards Association (CSA) - CSA approval for the USA -	US	 Physikalisch-Technische Bundesanstalt	DE	 Lloyd's Register of Shipping	GB
 Canadian Standards Association (CSA) Combined logo - CSA approval for Canada and the USA -	CA US	 KIWA Nederland B.V.	NL	 Nippon Kaiji Kyokai	JP
 Underwriters Laboratories Inc. (UL)	US	 VTT Expert Services Oy	FI	 Det Norske Veritas	NO
 Underwriters Laboratories Inc. (UL) - UL approval for Canada -	CA	 IBExU Institut für Sicherheitstechnik GmbH	DE	 Polski Rejestr Statków	PL
 Underwriters Laboratories Inc. (UL) Combined logo - UL approval for the USA and Canada -	US CA	 TÜV Rheinland do Brasil	BR	 Russian Maritime Register of Shipping	RU
 INSIEME PER LA QUALITA' E LA SICUREZZA	IT	 Technischer Überwachungsverein Nord	DE	 Korean Register of Shipping	KR
 Eurasian Conformity	BY KZ RU	 DEKRA EXAM GmbH	DE	 American Bureau of Shipping	US
 DEKRA Certification B.V.	NL	 Canadian Standards Association (CSA)	CA		
 Österreichischer Verband für Elektrotechnik	AT	 Canadian Standards Association (CSA) - CSA approval for the USA -	US		
 electrosuisse SEV Verband für Elektro-, Energie- und Informationstechnik	CH	 Canadian Standards Association (CSA) Combined logo - CSA approval for Canada and the USA -	CA US		
 Verband Deutscher Elektrotechniker e.V. (VDE) - Approval of drawings - Reports with production monitoring	DE	 Underwriters Laboratories Inc. (UL)	US		
 Berufsgenossenschaft (BG) GS Tested safety	DE	 Underwriters Laboratories Inc. (UL) - UL approval for Canada -	CA		
 Intertek ETL Listed - Approval for the USA -	US	 Underwriters Laboratories Inc. (UL) Combined logo - UL approval for the USA and Canada -	US CA		
 Intertek ETL Listed - Approval for Canada -	CA	 FM Approvals	US		
 Intertek ETL Listed - Approval for the USA and Canada -	US CA	 Eurasian Conformity for Ex-products	BY KZ RU		
 TÜV Rheinland Industrie Service GmbH	DE				
 China Compulsory Certification	CN				
 Korea Communications Commission	KR				

Dimensioning of clearances

Schematic for determining clearances

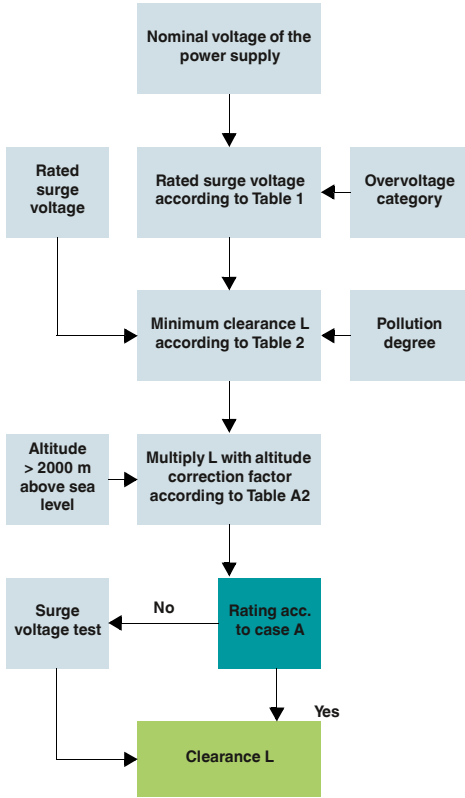

Rated surge voltages for equipment that is directly supplied by the low-voltage network (extract from Table 1)

Nominal voltage of the power supply system <sup>1)</sup> (mains) as per IEC 60038 <sup>3)</sup>		Conductor-neutral conductor voltage derived from the total nominal AC voltage or nominal DC voltage	Rated surge voltage <sup>2)</sup> [V]			
Three-phase [V]	Single-phase [V]		Overvoltage category <sup>4)</sup>			
		[V]	I	II	III	IV
		50	330	500	800	1500
		100	500	800	1500	2500
	120 to 240	150	800	1500	2500	4000
230/400	277/480	300	1500	2500	4000	6000
	400/690	600	2500	4000	6000	8000
	1000	1000	4000	6000	8000	12000

<sup>1)</sup> Refer to Annex B for application in existing deviating low-voltage networks and their nominal voltages.

<sup>2)</sup> Equipment with this rated surge voltage may be used in systems according to IEC 60364-4-443.

<sup>3)</sup> The slash, i.e., /, indicates a three-phase four-wire system. The lower value is the conductor-to-neutral-conductor voltage, whereas the higher value is the conductor-to-conductor voltage. When only one value is specified, it refers to a three-phase three-conductor system, and indicates the conductor-to-conductor voltage.

<sup>4)</sup> Refer to 2.2.2.1.1 for an explanation of overvoltage categories.

Minimum clearances for overvoltages (extract from Table 2)

Required rated impulse voltage <sup>1)</sup> <sup>5)</sup> [kV]	Condition A Non-homogeneous field (refer to 3.15)			Condition B Homogeneous field (refer to 3.14)		
	Pollution degree <sup>6)</sup>			Pollution degree <sup>6)</sup>		
	1 [mm]	2 [mm]	3 [mm]	1 [mm]	2 [mm]	3 [mm]
0.33 <sup>2)</sup>	0.01	0.2 <sup>3)</sup> 4)	0.8 <sup>4)</sup>	0.01	0.2 <sup>3)</sup> 4)	0.8 <sup>4)</sup>
0.40	0.02			0.02		
0.5 <sup>2)</sup>	0.04			0.04		
0.60	0.06			0.06		
0.80 <sup>2)</sup>	0.10			0.10		
1.0	0.15			0.15		
1.2	0.25	0.25		0.2		
1.5 <sup>2)</sup>	0.5	0.5		0.3	0.3	
2.0	1.0	1.0	1.0	0.45	0.45	
2.5 <sup>2)</sup>	1.5	1.5	1.5	0.6	0.6	
3.0	2.0	2.0	2.0	0.8	0.8	
4.0 <sup>2)</sup>	3	3	3	1.2	1.2	1.2
5.0	4	4	4	1.5	1.5	1.5
6.0 <sup>2)</sup>	5.5	5.5	5.5	2	2	2
8.0 <sup>2)</sup>	8	8	8	3	3	3
10	11	11	11	3.5	3.5	3.5
12 <sup>2)</sup>	14	14	14	4.5	4.5	4.5
15	18	18	18	5.5	5.5	5.5
20	25	25	25	8	8	8
25	33	33	33	10	10	10
30	40	40	40	12.5	12.5	12.5
40	60	60	60	17	17	17
50	75	75	75	22	22	22
60	90	90	90	27	27	27
80	130	130	130	35	35	35
100	170	170	170	45	45	45

<sup>1)</sup> This voltage is:

- For function insulation: the highest surge voltage expected for the clearance
- For basic insulation, if influenced directly or considerably by transient overvoltages from the low-voltage network: the rated surge voltage of the equipment
- For a different basic insulation: the highest surge voltage possible in the circuit.

<sup>2)</sup> Preferred values

<sup>3)</sup> For PCBs, the values of pollution degree 1 are applicable, except that no deviation below the value of 0.04 mm is permitted, as specified in Table 4.

<sup>4)</sup> Minimum clearances for pollution degrees 2 and 3 are based on the corresponding creepage distances. This resistance is reduced due to the effects of humidity.

<sup>5)</sup> Values can be interpolated for parts or circuits within equipment that are subjected to surge voltages.

<sup>6)</sup> The distances for pollution degree 4 are equal to those for pollution degree 3, except that the minimum clearance is 1.6 mm.

Altitude correction factors (extract from Table A.2)

Altitude [m]	Normal air pressure [kPa]	Multiplication factor for distances
2000	80.0	1.00
3000	70.0	1.14
4000	62.0	1.29
5000	54.0	1.48
6000	47.0	1.70
7000	41.0	1.95
8000	35.5	2.25
9000	30.5	2.62
10000	26.5	3.02
15000	12.0	6.67
20000	5.5	14.50

## Dimensioning of creepage distances

### Schematic for determining creepage distances

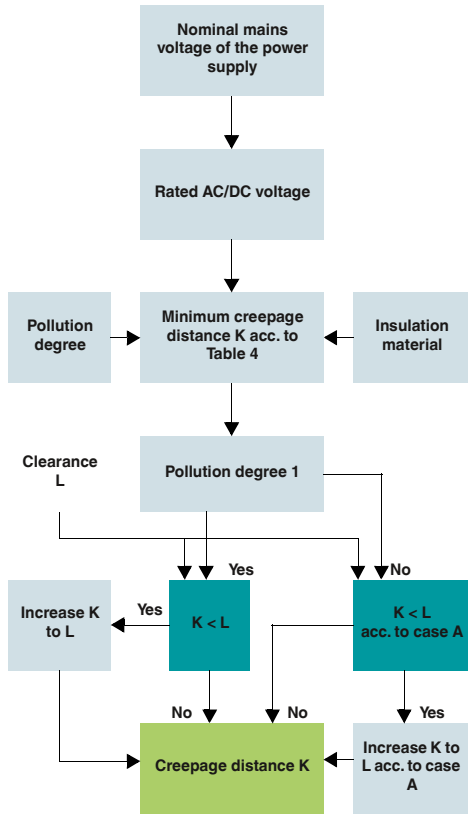

Nominal voltage of the power supply system (mains) *)	Voltages for Table 4	
	For conductor-to-conductor insulation 1)	For conductor-to-ground insulation 1)
	All systems	Three-conductor systems center point grounded
[V]	[V]	[V]
12.5	12.5	-
24	25	-
25	-	-
30	32	-
42	50	-
48	-	-
50 **)	-	-
60	63	-
30 - 60	63	32
100 **)	100	-
110	125	-
120	-	-
150 **)	160	-
220	250	-
110 - 220	250	125
220 - 240	-	-
300 **)	320	-
220 - 440	500	250
600 **)	630	-
480 - 960	1000	500
1000 **)	1000	-

1) Conductor-to-ground insulation levels for non-grounded systems or those grounded through impedance correspond to conductor-to-conductor insulation levels as the operating voltage of every conductor to ground can, in practice, reach the conductor-to-conductor voltage. This is based on the fact that the actual voltage to ground is determined by the insulation resistance and capacitive reactance of each conductor to ground. Therefore, a low (but permissible) insulation resistance of a conductor can practically ground this and raise the two others to conductor-to-conductor voltage to ground.

\*) Refer to 2.2.1 for correlation with the rated voltage.  
\*\*) These values correspond to the values in Table 1.

Nominal voltage of the power supply system (mains) *)	Voltages for Table 4		
	For conductor-to-conductor insulation	Insulation for conductor to ground	
		All systems	Three-phase four-conductor systems with grounded neutral conductor 2)
[V]	[V]	[V]	[V]
60	63	32	63
110/120/127	125	80	125
150 **)	160	-	160
208	200	125	200
220/230/240	250	160	250
300 **)	320	-	320
380/400/415	400	250	400
440	500	250	400
480/500	500	320	500
575	630	400	630
600 **)	630	-	630
660/690	630	400	630
720/830	800	500	800
960	1000	630	1000
1000 **)	1000	-	1000

1) Conductor-to-ground insulation levels for non-grounded systems or those grounded through impedance correspond to conductor-to-conductor insulation levels as the operating voltage of every conductor to ground can, in practice, reach the conductor-to-conductor voltage. This is based on the fact that the actual voltage to ground is determined by the insulation resistance and capacitive reactance of each conductor to ground. Therefore, a low (but permissible) insulation resistance of a conductor can practically ground this and raise the two others to conductor-to-conductor voltage to ground.

2) For equipment designed for use in three-phase four-conductor and three-phase three-conductor systems, grounded as well as non-grounded, only the values for three-conductor systems may be used.

\*) Refer to 2.2.1 for correlation with the rated voltage.  
\*\*) These values correspond to the values in Table 1.

### Creepage distances to prevent failures occurring due to creepage (extract from Table 4)

Voltage 1) r.m.s. value	Minimum creepage distances											
	Printed circuits			Pollution degree								
	Pollution degree			1			2			3		
	All insulation material groups	All insulation material groups except III b		All insulation material groups	Insulation material group			Insulation material group				
[V]	[mm]	[mm]	[mm]	I	II	III	I	II	III 2)			
10	0.025	0.04	0.08	0.4	0.4	0.4	1.00	1.00	1.00			
12.5	0.025	0.04	0.09	0.42	0.42	0.42	1.05	1.05	1.05			
16	0.025	0.04	0.10	0.45	0.45	0.45	1.10	1.10	1.10			
20	0.025	0.04	0.110	0.48	0.48	0.48	1.20	1.20	1.20			
25	0.025	0.04	0.125	0.5	0.5	0.5	1.25	1.25	1.25			
32	0.025	0.04	0.140	0.53	0.53	0.53	1.30	1.30	1.30			
40	0.025	0.04	0.16	0.56	0.8	1.1	1.4	1.6	1.8			
50	0.025	0.04	0.18	0.6	0.85	1.2	1.5	1.7	1.9			
63	0.040	0.63	0.20	0.63	0.9	1.25	1.6	1.8	2.0			
80	0.063	0.10	0.22	0.67	0.95	1.3	1.7	1.9	2.1			
100	0.10	0.16	0.25	0.71	1.0	1.4	1.8	2.0	2.2			
125	0.16	0.25	0.28	0.75	1.05	1.5	1.9	2.1	2.4			
160	0.25	0.4	0.32	0.8	1.1	1.6	2.0	2.2	2.5			
200	0.40	0.63	0.42	1.0	1.4	2.0	2.5	2.8	3.2			
250	0.56	1.0	0.56	1.25	1.8	2.5	3.2	3.6	4.0			
320	0.75	1.6	0.75	1.6	2.2	3.2	4.0	4.5	5.0			
400	1.0	2.0	1.00	2.0	2.8	4.0	5.0	5.6	6.3			
500	1.3	2.5	1.30	2.5	3.6	5.0	6.3	7.1	8.0			
630	1.8	3.2	1.80	3.2	4.5	6.3	8.0	9	10.0			
800	2.4	4.0	2.40	4.0	5.6	8.0	10.0	11	12.5			
1000	3.2	5.0	3.20	5.0	7.1	10	12.5	14	16.0			
1250			4.20	6.3	9	12.5	16	18	20			
1600			5.60	8	11	16	20	22	25			
2000			7.50	10	14	20	25	28	32			
2500			10	12.5	18	25	32	36	40			
3200			12.5	16	22	32	40	45	50			
4000			16	20	28	40	50	56	63			
5000			20	25	36	50	63	71	80			
6300			25	32	45	63	80	90	100			
8000			32	40	56	80	100	110	125			
10000			40	50	71	100	125	140	160			

1) This voltage is:  
a) For function insulation: the working voltage.  
b) For basic and additional insulation of a circuit supplied directly by the low-voltage network: either the voltage selected from Table 3 a or 3 b on the basis of the rated voltage of the equipment or the rated insulation voltage.  
c) For basic and additional insulation of systems, equipment, and internal circuits which are not supplied directly from the mains: the highest r.m.s. value of the voltage that, within the bounds of the rated data, can occur in the system, the equipment or the internal circuit, when supplied with rated voltage and in the case of the most unfavorable combination of operating conditions.

2) With pollution degree 3, insulation material group III b is not recommended for use if voltages are greater than 630 V.

# Index

## Alphabetical

Type	Order No.	Page	Type	Order No.	Page	Type	Order No.	Page	Type	Order No.	Page	
<b>A</b>	ADAPTER KOAX TYP F	2880972	180	CB TM1 5A M1 P	2800851	329	CTM 10-MAG	2838610	169	ECP-E2-12A	0900207	325
				CB TM1 5A SFB P	2800840	269	CTM 1X2-12DC	2838597	102	ECP-E2-1A	0900139	325
				CB TM1 6A F1 P	2800863	330	CTM 1X2-24DC	2838513	102	ECP-E2-2A	0900236	325
				CB TM1 6A M1 P	2800852	329	CTM 1X2-60DC	2838568	102	ECP-E2-3A	0900333	325
<b>B</b>	BATTERY MOUNTING CASE BATTERY MOUNTING KIT BLT-T2-1S-320-UT BLT-T2-320-UT	2320458 2320788 2906101 2906100	289 289 69 69	CB TM1 6A SFB P	2800841	269	CTM 1X2-110AC	2838539	166	ECP-E2-4A	0900430	325
				CB TM1 8A F1 P	2800864	330	CTM 2X1-12DC	2838584	119	ECP-E2-6A	0900634	325
				CB TM1 8A M1 P	2800853	329	CTM 2X1-24DC	2838500	119	ECP-E2-8A	0900838	325
				CB TM1 8A SFB P	2800842	328	CTM 2X1-60DC	2838542	119	ECP-E3 10A	0912050	325
<b>C</b>	C-SAT-BOX C-TV-SAT C-TV/HIFI C-UB/E	2880561 2856993 2857002 2763701	180 181 181 177	CB TM2 0.5A F1 P	2800890	330	CTM 2X1-110AC	2838526	166	ECP-E3 12A	0912052	325
				CB TM2 0.5A M1 P	2800879	329	CTM 2X1-180DC-GS	2838636	167	ECP-E3 1A	0912041	325
				CB TM2 0.5A SFB P	2800868	328	CTM 2X1-180DC-GS-P	2838623	167	ECP-E3 2A	0912042	325
				CB TM2 10A F1 P	2800898	330	CTM EST	2838649	102	ECP-E3 3A	0912043	325
<b>D</b>	D-LAN-19"-12 D-LAN-19"-16 D-LAN-19"-20 D-LAN-19"-24	2800877 2800900 2800889 2800878	328 330 329 328	CB TM2 10A M1 P	2800887	329	CTM ISDN	2838555	167	ECP-E3 4A	0912044	325
				CB TM2 10A SFB P	2800876	328				ECP-E3 6A	0912046	325
				CB TM2 12A F1 P	2800899	330				ECP-E3 8A	0912048	325
				CB TM2 12A M1 P	2800888	329				EML (20XE)R	0803452	77
<b>E</b>	E-M (20XE)R YE	2880150 2880147 2880134 2838791	143 143 143 143	CB TM2 12A SFB P	2800877	328	D-LAN-19"-4	2880176	143	F-MS 12	2817987	55
				CB TM2 16A F1 P	2800900	330	D-LAN-19"-8	2880163	143	F-MS 12 ST	2817990	63
				CB TM2 16A M1 P	2800889	329	D-LAN-19"-D-P	2880192	143	F-MS 12-UD ST	2858328	63
				CB TM2 16A SFB P	2800878	328	D-LAN-CAT.5-FP	2800723	143	F-MS 12/FM	2817974	55
<b>F</b>	F-MS 12 F-MS 12 ST F-MS 12-UD ST F-MS 12/FM	2880561 2856993 2857002 2763701	180 181 181 177	CB TM2 1A F1 P	2800891	330	D-LAN-19"-4	2880176	143	F-MS 2000/30 ST	2805392	56
				CB TM2 1A M1 P	2800880	329	DK-BIC-35	2749880	77	F-MS-T1/T2 50 ST	2800191	36
				CB TM2 1A SFB P	2800869	328	DT-LAN-CAT.6+	2881007	142	FBS 2-6	3030336	331
				CB TM2 2A F1 P	2800892	330	DT-TELE-RJ45	2882925	162	FBS 2-6 BU	3036932	331
<b>G</b>	G-UB-5DC/E G-UB-5DC/E 75 G-UB-24DC/E CB 1/10-1/10 UT-BE	2782300 2763604 2782313 2801305	177 177 177 331	CB TM2 2A M1 P	2800881	329	DT-TELE-SHDSL	2801593	162	FBS 2-6 GY	3032237	331
				CB TM2 2A SFB P	2800870	328	DT-UFB-485/BS	2920612	147	FBS 3-6	3030242	331
				CB TM2 3A F1 P	2800893	330	DT-UFB-IB-RB0	2800056	159	FBS 3-6 BU	3036945	331
				CB TM2 3A M1 P	2800882	329	DT-UFB-IB-RB1	2800055	159	FBS 3-6 GY	3032240	331
<b>H</b>	H-1/6-2/4 PT-BE H-E1 24DC/10A S-C P H-E1 24DC/10A S-R P H-E1 24DC/1A NC P	2800929 2800928 2800914 2800915	331 323 323 323	CB TM2 3A SFB P	2800871	328	DT-TELE-V24/S-9-SB	2803069	144	FBS 4-6	3030255	331
				CB TM2 4A F1 P	2800894	330				FBS 4-6 BU	3036958	331
				CB TM2 4A M1 P	2800883	329				FBS 4-6 GY	3032279	331
				CB TM2 4A SFB P	2800872	328				FBS 5-6	3030349	331
<b>I</b>	I-E1 24DC/1A NO P I-E1 24DC/1A S-C P I-E1 24DC/1A S-R P I-E1 24DC/2A NC P	2800901 2800922 2800908 2800916	322 323 323 323	CB TM2 5A F1 P	2800895	330	EC-E 0.5A DC24V	0903041	327	FBS 5-6 BU	3036961	331
				CB TM2 5A M1 P	2800884	329	EC-E 1A DC24V	0903042	327	FBS 5-6 GY	3032266	331
				CB TM2 5A SFB P	2800873	328	EC-E 2A DC24V	0903043	327	FBS 10-6	3030271	331
				CB TM2 6A F1 P	2800896	330	EC-E 3A DC24V	0903044	327	FBS 10-6 BU	3032198	331
<b>J</b>	J-E1 24DC/2A NO P J-E1 24DC/2A S-C P J-E1 24DC/2A S-R P J-E1 24DC/3A NC P	2800902 2800923 2800909 2800917	322 323 323 323	CB TM2 6A M1 P	2800885	329	EC-E 4A DC24V	0903045	327	FBS 10-6 GY	3032253	331
				CB TM2 6A SFB P	2800874	328	EC-E 6A DC24V	0903046	327	FBS 20-6	3030365	331
				CB TM2 8A F1 P	2800897	330	EC-E 8A DC24V	0903047	327	FBS 20-6 BU	3032208	331
				CB TM2 8A M1 P	2800886	329	EC-E 10A DC24V	0903048	327	FBS 50-6	3032224	331
<b>K</b>	K-E1 24DC/3A NO P K-E1 24DC/3A S-C P K-E1 24DC/3A S-R P K-E1 24DC/4A NC P	2800903 2800924 2800910 2800918	322 323 323 323	CB TM2 8A SFB P	2800875	328	EC-E 12A DC24V	0903049	327	FBS 50-6 BU	3032211	331
				CBM E4 24DC/0.5-10A NO-R	2905743	314	EC-E1 0.5A	0903022	326	FBST 500 TMC-N GY	0901028	326
				CBM E8 24DC/0.5-10A NO-R	2905744	314	EC-E1 10A	0903030	326	FBST 500-PLC BU	2966692	326
				CBMC E4 24DC/1-10A NO	2906032	316	EC-E1 12A	0903031	326	FBST 500-PLC RD	2966786	326
<b>L</b>	L-E1 24DC/4A NO P L-E1 24DC/4A S-C P L-E1 24DC/4A S-R P L-E1 24DC/6A NC P	2800904 2800925 2800911 2800919	322 323 323 323	CBMC E4 24DC/1-10A NO-C	2908716	317	EC-E1 1A	0903023	326	FLT-ISG-100-EX	2905579	78
				CBMC E4 24DC/1-4A NO	2906031	316	EC-E1 2A	0903024	326	FLT-ISG-BR-11	2905580	79
				CBMC E4 24DC/1-4A NO-C	2908713	317	EC-E1 3A	0903025	326	FLT-ISG-BR-14	2905581	79
				CHECKMASTER 2	2905256	195	EC-E1 4A	0903026	326	FLT-ISG-BR-18	2905582	79
<b>M</b>	M-E1 24DC/6A NO P M-E1 24DC/6A S-C P M-E1 24DC/6A S-R P M-E1 24DC/8A S-C P	2800905 2800926 2800912 2800927	322 323 323 323	CM 2-PA-CTM	2905282	195	EC-E1 6A	0903028	326	FLT-ISG-BR-22	2905583	79
				CM 2-PA-FLT/VAL-CP/SEC	2905283	195	EC-E1 8A	0903029	326	FLT-ISG-BR-26	2905757	79
				CM 2-PA-PT/A	2907891	195	EC-E4 0.5A	0903040	326	FLT-ISG-BR-30	2905758	79
				CM 2-PA-PT/PLT	2905284	195	EC-E4 10A	0903038	326	FLT-ISG-BR-33	2905759	79
<b>N</b>	N-E1 24DC/8A S-R P N-PT BRIDGE N-S-BE N-TM1 0.5A F1 P	2800913 2801014 2905067 2800857	323 322 331 330	CM 2-PA-PT4/PLT3S	2907019	195	EC-E4 12A	0903039	326	FLT-ISG-BR-36	2905760	79
				CM 2-PA-SEC-HYBRID	2907889	195	EC-E4 1A	0903032	326	FLT-ISG-BR-39	2905761	79
				CM 2-PA-TTC	2908707	195	EC-E4 2A	0903033	326	FLT-ISG-BR-42	2905762	79
				CM 2-PA-VAL-MS	2905265	195	EC-E4 3A	0903034	326	FLT-ISG-BR-48	2905763	79
<b>O</b>	O-TM1 0.5A M1 P O-TM1 0.5A SFB P O-TM1 10A F1 P O-TM1 10A M1 P	2800846 2800835 2800865 2800854	329 269 330 328	CN-LAMBDA/4-0.47-BB	2800021	178	EC-E4 4A	0903035	326	FLT-ISG-BR-56	2905764	79
				CN-LAMBDA/4-0.47-SB	2800022	178	EC-E4 6A	0903036	326	FLT-ISG-BR-62	2905765	79
				CN-LAMBDA/4-2.25-BB	2801057	178	EC-E4 8A	0903037	326	FLT-ISG-CA-100	2905589	79
				CN-LAMBDA/4-2.25-SB	2801056	178	ECP 4	0912034	325	FLT-ISG-CA-200	2905590	79
<b>P</b>	P-TM1 10A SFB P P-TM1 12A F1 P P-TM1 12A M1 P P-TM1 12A SFB P	2800843 2800866 2800855 2800844	328 330 329 328	CN-LAMBDA/4-5.9-BB	2838490	179	EC-P 6	0912033	325	FLT-ISG-CA-300	2905591	79
				CN-LAMBDA/4-5.9-SB	2800023	179	ECP 1-2	0912018	325	FLT-ISG-PL-11	2905584	79
				CN-UB-280DC-3-BB	2801050	176	ECP 10	0912020	325	FLT-ISG-PL-14	2905586	79
				CN-UB-280DC-3-SB	2801051	176	ECP 2	0911034	325	FLT-ISG-PL-18	2905587	79
<b>Q</b>	Q-TM1 16A F1 P Q-TM1 16A M1 P Q-TM1 16A SFB P Q-TM1 1A F1 P	2800867 2800856 2800845 2800858	330 329 328 330	CN-UB-70DC-6-BB	2803166	176	ECP 3	0911047	325	FLT-ISG-PL-22	2905588	79
				CN-UB-70DC-6-SB	2803153	176	ECP 3-6	0916536	325	FLT-ISG-PL-26	2905745	79
				CN-UB/E	2763691	177	ECP 8	0912019	325	FLT-ISG-PL-30	2905746	79
				CN-UB/E-BB	2817686	177	ECP-E 1A	0900113	324	FLT-ISG-PL-33	2905747	79
<b>R</b>	R-TM1 1A M1 P R-TM1 1A SFB P R-TM1 2A F1 P R-TM1 2A M1 P	2800847 2800836 2800859 2800848	329 269 330 329	CN-UB/MP	2818135	176	EC-P 2A	0900210	324	FLT-ISG-PL-36	2905754	79
				CN-UB/MP-90DEG-50	2803137	176	EC-P 3A	0900317	324	FLT-ISG-PL-39	2905755	79
				CSMA-LAMBDA/4-2.0-BS-SET	2800491	179	EC-P 4A	0900414	324	FLT-ISG-PL-42	2905756	79
				CT 1-10-ES	2765547	169	EC-P 6A	0900618	324	FLT-SEC-H-T1-1C-264/25-FM	2801615	28
<b>S</b>	S-TM1 2A SFB P S-TM1 3A F1 P S-TM1 3A M1 P S-TM1 3A SFB P	2800837 2800860 2800849 2800838	269 330 329 269	CT 10-2/2-GS	2765398	168	EC-P 8A	0900812	324	FLT-SEC-H-T1-1C-440/25-FM	2907259	28
				CT 10-2/2-GS/3E	2765408	168	EC-P 10A	0901002	324	FLT-SEC-H-T1-264/25-P	2905968	28
				CT 10-2/2-GS/3E-110AC	2920829	168	EC-P 12A	0900126	324	FLT-SEC-H-T1-3C-264/25-FM	2905871	28
				CT 10-MB/3	2765372	169	EC-P 10A	0900100	324	FLT-SEC-H-T1-3C-440/25-FM	2907260	28
<b>T</b>	T-TM1 4A F1 P T-TM1 4A M1 P T-TM1 4A SFB P T-TM1 5A F1 P	2800861 2800850 2800839 2800862	330 329 269 330	CT 10-MB/10	2765385	169	EC-P 12A	0900126	324			
				CT 10-TL	2765356	169	EC-P 10A	0900100	324			
				CT-KDT	2765518	169	EC-P 12A	0900126	324			
				CT-TERMBLOCK 10 DA	0441711	169	EC-P 10A	0900100	325			

Type	Order No.	Page	Type	Order No.	Page	Type	Order No.	Page	Type	Order No.	Page
FLT-SEC-H-T1-440/25-P	2907261	28	MINI-DC-UPS/24DC/2	2866640	301	PT 2-TELE	2882828	164	PTHQ-2X1+F-48DC-PT	2801250	111
FLT-SEC-P-T1-1C-264/50-FM	2907387	35	MINI-PS- 10- 42AC/15-60DC/3	2320199	257	PT 2-TELE-ST	2838733	164	PTHQ-2X1+F-48DC-UT	2800790	111
FLT-SEC-P-T1-1C-350/25-FM	2905414	33	MINI-PS- 12- 24DC/ 5-15DC/2	2320018	256	PT 2X1+F-BE	2856142	112	PTHQ-2X1-24DC-PT	2801247	110
FLT-SEC-P-T1-1C-440/35-FM	2905987	30	MINI-PS- 12- 24DC/24DC/1	2866284	256	PT 2X1- 5DC-ST	2856061	112	PTHQ-2X1-24DC-UT	2800787	110
FLT-SEC-P-T1-1S-264/50-FM	2907388	35	MINI-PS- 12- 24DC/48DC/0.7	2320021	257	PT 2X1-12AC-ST	2856090	113	PTHQ-2X1-48DC-PT	2801249	110
FLT-SEC-P-T1-1S-350/25-FM	2905415	33	MINI-PS- 48- 60DC/24DC/1	2866271	257	PT 2X1-12DC-ST	2856074	112	PTHQ-2X1-48DC-UT	2800789	110
FLT-SEC-P-T1-1C-350/25-FM	2907391	34	MINI-PS-100-240AC/ 5DC/3	2938714	236	PT 2X1-24AC-ST	2856100	113	PTHQ-2X2+F-12DC-PT	2801262	97
FLT-SEC-P-T1-2C-350/25-FM	2905416	32	MINI-PS-100-240AC/10-15DC/2	2938756	236	PT 2X1-24DC-ST	2856087	112	PTHQ-2X2+F-12DC-UT	2800985	97
FLT-SEC-P-T1-2S-350/25-FM	2905418	32	MINI-PS-100-240AC/10-15DC/8	2866297	237	PT 2X1-BE	2856139	112	PTHQ-2X2+F-24DC-PT	2801264	97
FLT-SEC-P-T1-350/25-P	2905422	31	MINI-PS-100-240AC/24DC/1.3	2866446	234	PT 2X1-VF-120AC	2859327	114	PTHQ-2X2+F-24DC-UT	2800981	97
FLT-SEC-P-T1-3C-264/50-FM	2907390	34	MINI-PS-100-240AC/24DC/1.5/EX	2866653	237	PT 2X1-VF-120AC-ST	2856799	114	PTHQ-2X2+F-48DC-PT	2801266	97
FLT-SEC-P-T1-3C-350/25-FM	2905419	31	MINI-PS-100-240AC/24DC/2	2938730	235	PT 2X1-VF-230AC	2805460	114	PTHQ-2X2+F-48DC-UT	2800987	97
FLT-SEC-P-T1-3C-440/35-FM	2905988	29	MINI-PS-100-240AC/24DC/4	2938837	235	PT 2X1-VF-230AC-ST	2921365	114	PTHQ-2X2+F-5DC-PT	2801260	97
FLT-SEC-P-T1-3C-264/50-FM	2905989	34	MINI-PS-100-240AC/24DC/C2LPS	2866336	235	PT 2X1VA- 60AC-ST	2839172	114	PTHQ-2X2+F-5DC-UT	2800809	97
FLT-SEC-P-T1-3S-350/25-FM	2905421	31	MINI-PS-100-240AC/2X15DC/1	2938743	237	PT 2X1VA-120AC-ST	2839185	114	PTHQ-2X2-12DC-PT	2801261	97
FLT-SEC-P-T1-3S-440/35-FM	2908264	29	MINI-SCREW-USB-DATACABLE	2908217	283	PT 2X1VA-230AC-ST	2839198	114	PTHQ-2X2-12DC-UT	2800984	97
FLT-SEC-P-T1-440/35-P	2905989	29	MINI-SYS-PS-100-240AC/24DC/1.5	2866983	234	PT 2X2+F-BE	2839224	99	PTHQ-2X2-24DC-PT	2801263	97
FLT-SEC-P-T1-N/PE-350/100-FM	2905472	33	MNT-1 CH II	2882255	74	PT 2X2- 5DC-ST	2838241	99	PTHQ-2X2-24DC-UT	2800980	97
FLT-SEC-P-T1-N/PE-350/100-P	2905473	31	MNT-1 D	2882200	74	PT 2X2-12DC-ST	2838254	99	PTHQ-2X2-48DC-PT	2801265	97
FLT-SEC-P-T1-N/PE-440/100-FM	2907262	30	MNT-1 D/WH	2882213	74	PT 2X2-24AC-ST	2838283	99	PTHQ-2X2-48DC-UT	2800986	97
FLT-SEC-P-T1-N/PE-440/100-P	2907263	29	MNT-NET B/F	2882226	74	PT 2X2-24DC-ST	2838228	99	PTHQ-2X2-5DC-PT	2801259	97
FLT-SEC-T1+T2-1C-350/25-FM	2905465	44	MNT-TAE D	2882381	74	PT 2X2-BE	2839208	99	PTHQ-2X2-5DC-UT	2800807	97
FLT-SEC-T1+T2-1S-350/25-FM	2905466	43	MNT-TAE D/WH	2882394	74	PT 2X2-FF-ST	2800755	161	PTHQ-2X2-EX-24DC-P	2801515	129
FLT-SEC-T1+T2-2C-350/25-FM	2905467	43	MNT-TEL B/F	2882404	75	PT 2X2-HF- 5 DC-ST	2839567	161	PTHQ-2X2-EX-24DC-UT	2801513	129
FLT-SEC-T1+T2-2S-350/25-FM	2905468	43	MNT-TELE E	2882417	75	PT 2X2-HF-12 DC-ST	2839570	161	PTHQ-3-HF+F-12DC-PT	2801289	145
FLT-SEC-T1+T2-3C-350/25-FM	2905469	42	MNT-TELE S/WH	2880901	75	PT 2X2-HF-24 DC-ST	2839729	161	PTHQ-3-HF+F-12DC-UT	2800995	145
FLT-SEC-T1+T2-3S-350/25-FM	2905470	42	MNT-TV-SAT B/F	2882307	75	PT 2XEX(II)-24DC-ST	2838225	132	PTHQ-3-HF-12DC-PT	2801288	153
FLT-SEC-T1-350/25-P	2905471	42	MNT-TV-SAT D	2882284	75	PT 2XEX(I)-BE	2839279	132	PTHQ-3-HF-12DC-UT	2800786	153
FOC-SJ:14-ST/.../...	1417723	190	MNT-TV-SAT D/WH	2882297	75	PT 3-HF-12DC-ST	2858043	145	PTHQ-3-PB-PT	2801286	153
FUSE 5A/32V FK-1	2908367	299	MPB 18/1- 2	2809209	77	PT 3-PB-ST	2858030	154	PTHQ-3-PB-UT	2800785	153
FUSE 10A/32V FK1	2908364	305	MPB 18/1- 3	2809212	77	PT 4-F-BE	2839415	116	PTHQ-4X1+F-24DC-PT	2801272	111
FUSE 15A/32V FK1	2908360	286	MPB 18/1- 4	2809225	77	PT 4- 5DC-ST	2839211	116	PTHQ-4X1+F-24DC-UT	2800983	111
FUSE 15A/32V FKS ATO	2908361	294	MPB 18/1- 5	2817864	77	PT 4-12DC-ST	2839237	116	PTHQ-4X1+F-48DC-PT	2801274	111
FUSE 25A/32V ATOF	2908366	286	MPB 18/1- 6	2748564	77	PT 4-24AC-ST	2800078	116	PTHQ-4X1+F-48DC-UT	2801220	111
FUSE 25A/32V FKS	2908363	305	MPB 18/1- 8	2748577	77	PT 4-24DC-ST	2839240	116	PTHQ-4X1-24DC-PT	2801271	111
			MPB 18/1- 9	2748580	77	PT 4-BE	2839402	115	PTHQ-4X1-24DC-UT	2800982	111
			MPB 18/1-12	2748593	77	PT 4-EX(II)-24DC-ST	2839253	134	PTHQ-4X1-48DC-PT	2801273	111
			MPB 18/1-57	2809238	77	PT 4-EX(I)-BE	2839486	134	PTHQ-4X1-48DC-UT	2801219	111
			MPB 18/1-6/35	2908705	77	PT 4-F-ST	2858441	115	PTHQ-5-HF+F-12DC-PT	2801295	147
			MPB 18/1-8/35	2908704	77	PT 4X1+F-BE	2839376	113	PTHQ-5-HF+F-12DC-UT	2800801	147
						PT 4X1- 5DC-ST	2838306	113	PTHQ-5-HF+F-5DC-PT	2801292	147
						PT 4X1-12DC-ST	2838319	113	PTHQ-5-HF+F-5DC-UT	2800798	147
						PT 4X1-24AC-ST	2838351	113	PTHQ-5-HF-12DC-PT	2801293	146
						PT 4X1-24DC-ST	2838322	113	PTHQ-5-HF-12DC-UT	2800799	146
						PT 4X1-48AC-ST	2804856	113	PTHQ-5-HF-5DC-PT	2801291	146
						PT 4X1-48DC-ST	2858014	113	PTHQ-5-HF-5DC-UT	2800797	146
						PT 4X1-BE	2839363	113	PTHQ-PTB-PT	2801296	96
						PT 5-HF- 5 DC-ST	2838762	147	PTHQ-PTB-UT	2800768	96
						PT 5-HF-12 DC-ST	2838775	147	PWT 100-800AC-FM	2800531	40
						PT 5-HF-24DC-ST	2906002	160	PWT 35-800AC-FM	2800419	40
						PT 6-FSI/C	3212166	334	PWT CCT-SET	2800532	40
						PT 6-FSI/C-LED 12	3212169	334	PWT CCT-SET 4	2905613	40
						PT 6-FSI/C-LED 24	3212172	334			
						PT 6-FSI/C-LED 48	3212175	334			
						PT PE/S+1X2-24-ST	2819008	99			
						PT PE/S+1X2-BE	2856265	99			
						PT-BE/FM	2839282	114	QUINT-BAT/24DC/ 3.4AH	2866349	303
						PTHQ-1X2+F-12DC-PT	2801254	97	QUINT-BAT/24DC/ 7.2AH	2866352	303
						PTHQ-1X2+F-12DC-UT	2800975	97	QUINT-BAT/24DC/12AH	2866365	303
						PTHQ-1X2+F-24DC-PT	2801256	97	QUINT-ORING/24DC/2X10/1X20	2320173	260
						PTHQ-1X2+F-24DC-UT	2800977	97	QUINT-ORING/24DC/2X20/1X40	2320186	261
						PTHQ-1X2+F-48DC-PT	2801258	97	QUINT-ORING/24DC/2X40/1X80	2902879	261
						PTHQ-1X2+F-48DC-UT	2800979	97	QUINT-PS-ADAPTERS/1	2938196	268
						PTHQ-1X2+F-5DC-PT	2801252	97	QUINT-PS-ADAPTERS/2	2938206	268
						PTHQ-1X2+F-5DC-UT	2800792	97	QUINT-PS/12DC/12DC/8	2905007	251
						PTHQ-1X2-12DC-PT	2801253	96	QUINT-PS/12DC/24DC/ 5	2320131	250
						PTHQ-1X2-12DC-UT	2800793	96	QUINT-PS/1AC/12DC/15	2866718	212
						PTHQ-1X2-24DC-PT	2801255	96	QUINT-PS/1AC/12DC/20	2866721	212
						PTHQ-1X2-24DC-UT	2800976	96	QUINT-PS/1AC/24DC/ 3.5	2866747	210
						PTHQ-1X2-48DC-PT	2801257	96	QUINT-PS/1AC/24DC/ 5/CO	2320908	216
						PTHQ-1X2-48DC-UT	2800978	96	QUINT-PS/1AC/24DC/10/CO	2320911	217
						PTHQ-1X2-5DC-PT	2801251	96	QUINT-PS/1AC/24DC/20/CO	2320898	217
						PTHQ-1X2-5DC-UT	2800791	96	QUINT-PS/1AC/24DC/40	2866789	210
						PTHQ-1X2-EX-24DC-P	2801514	129	QUINT-PS/12DC/48DC/ 5	2866679	213
						PTHQ-1X2-EX-24DC-UT	2801512	129	QUINT-PS/1AC/48DC/10	2866682	213
						PTHQ-1X2-TELE-P	2800782	163	QUINT-PS/1AC/48DC/20	2866695	213
						PTHQ-1X2-TELE-PT	2801290	163	QUINT-PS/24DC/12DC/ 8	2320115	249
						PTHQ-1X2-TELE-UT	2800769	163	QUINT-PS/24DC/24DC/ 5	2320034	248
						PTHQ-2X1+F-24DC-PT	2801248	111	QUINT-PS/24DC/24DC/ 5/CO	2320542	254
						PTHQ-2X1+F-24DC-UT	2800788	111	QUINT-PS/24DC/24DC/10	2320092	248

# Index

## Alphabetical

Type	Order No.	Page	Type	Order No.	Page	Type	Order No.	Page	Type	Order No.	Page
QUINT-PS/24DC/24DC/10/CO	2320555	254	STEP-DIODE/5-24DC/2X5/1X10	2868806	267	TTC-6-1X2-M-24DC-PT-I	2906726	94	TTC-6P-2X1-12DC-UT-I	2908201	104
QUINT-PS/24DC/24DC/20	2320102	249	STEP-PS/ 1AC/ 5DC/2	2320513	242	TTC-6-1X2-M-24DC-UT-I	2906713	94	TTC-6P-2X1-24DC-PT-I	2906816	104
QUINT-PS/24DC/24DC/20/CO	2320568	255	STEP-PS/ 1AC/ 5DC/6.5	2868541	243	TTC-6-1X2-M-EX-24DC-UT-I	2906820	128	TTC-6P-2X1-24DC-UT-I	2906810	104
QUINT-PS/24DC/48DC/ 5	2320128	249	STEP-PS/ 1AC/12DC/1	2868538	244	TTC-6-2-24DC-PT	2906806	120	TTC-6P-2X1-48DC-PT-I	2908204	104
QUINT-PS/2AC/1DC/24DC/20	2320830	215	STEP-PS/ 1AC/12DC/1.5	2868567	245	TTC-6-2-24DC-UT	2906800	120	TTC-6P-2X1-48DC-UT-I	2908203	104
QUINT-PS/3AC/24DC/20/CO	2320924	217	STEP-PS/ 1AC/12DC/1.5/FL	2868554	244	TTC-6-2-HC-24DC-PT-I	2908439	107	TTC-6P-2X1-F-12DC-PT-I	2908206	105
QUINT-PS/3AC/24DC/40	2866802	211	STEP-PS/ 1AC/12DC/3	2868570	245	TTC-6-2-HC-24DC-UT-I	2908438	107	TTC-6P-2X1-F-12DC-UT-I	2908205	105
QUINT-PS/3AC/48DC/20	2320827	214	STEP-PS/ 1AC/12DC/5	2868583	245	TTC-6-2-HC-M-24DC-PT-I	2906731	107	TTC-6P-2X1-F-48DC-PT-I	2908209	105
QUINT-PS/48DC/24DC/ 5	2320144	252	STEP-PS/ 1AC/15DC/4	2868619	243	TTC-6-2-HC-M-24DC-UT-I	2906719	107	TTC-6P-2X1-F-48DC-UT-I	2908208	105
QUINT-PS/48DC/48DC/5	2905008	253	STEP-PS/ 1AC/24DC/0.5	2868596	238	TTC-6-2X1-24DC-PT	2906805	108	TTC-6P-2X1-F-M-24DC-PT-I	2906794	105
QUINT-PS/60-72DC/24DC/10	2905009	253	STEP-PS/ 1AC/24DC/0.75	2868635	239	TTC-6-2X1-24DC-UT	2906799	108	TTC-6P-2X1-F-M-24DC-UT-I	2906784	105
QUINT-PS/60-72DC/24DC/10/CO	2905011	255	STEP-PS/ 1AC/24DC/0.75/FL	2868622	239	TTC-6-2X1-F-M-24DC-PT-I	2906776	108	TTC-6P-2X1-M-24DC-PT-I	2906753	104
QUINT-PS/96-110DC/24DC/10	2905010	253	STEP-PS/ 1AC/24DC/1.75	2868648	240	TTC-6-2X1-F-M-24DC-UT-I	2906767	108	TTC-6P-2X1-M-24DC-UT-I	2906741	104
QUINT-PS/96-110DC/24DC/10/CO	2905012	255	STEP-PS/ 1AC/24DC/2.5	2868651	240	TTC-6-2X1-M-24DC-PT-I	2906729	108	TTC-6P-2X1-M-EX-24DC-UT-I	2906825	133
QUINT-PS/FAN/4	2320076	268	STEP-PS/ 1AC/24DC/3.8/C2LPS	2868677	241	TTC-6-2X1-M-24DC-UT-I	2906716	108	TTC-6P-3-HF-F-M-12DC-PT-I	2906796	151
QUINT-UPS/ 1AC/ 1AC/500VA	2320270	280	STEP-PS/ 1AC/24DC/4.2	2868664	241	TTC-6-2X1-M-EX-24DC-UT-I	2906821	133	TTC-6P-3-HF-F-M-12DC-UT-I	2906786	151
QUINT-UPS/ 24DC/ 24DC/ 5/1.3AH	2320254	294	STEP-PS/ 1AC/48DC/2	2868680	243	TTC-6-2XTVSD-24DC-PT	2906808	124	TTC-6P-3-HF-F-M-24DC-PT-I	2906797	151
QUINT-UPS/ 24DC/ 24DC/10	2320225	275	STEP-PS/277AC/24DC/3.5	2904945	241	TTC-6-3-HF-F-M-12DC-PT-I	2906778	151	TTC-6P-3-HF-F-M-24DC-UT-I	2906787	151
QUINT-UPS/ 24DC/ 24DC/10/3.4AH	2320267	294	STEP-PS/48AC/24DC/0.5	2868716	239	TTC-6-3-HF-F-M-12DC-UT-I	2906769	151	TTC-6P-3-HF-F-M-EX-12DC-UT-I	2906826	157
QUINT-UPS/ 24DC/ 24DC/20	2320238	275	STEP-UPS/12DC/12DC/4	2868693	298	TTC-6-3-HF-F-M-24DC-PT-I	2906779	151	TTC-6P-3-HF-F-M-EX-24DC-UT-I	2906828	157
QUINT-UPS/ 24DC/ 24DC/40	2320241	275	STEP-UPS/24DC/24DC/3	2868703	298	TTC-6-3-HF-F-M-24DC-UT-I	2906770	151	TTC-6P-3-HF-M-12DC-PT-I	2906756	151
QUINT-UPS/ 24DC/12DC/5/24DC/10	2320461	276	SVP 2E- 48AC	2788919	168	TTC-6-3-HF-F-M-EX-12DC-UT-I	2906822	156	TTC-6P-3-HF-M-12DC-UT-I	2906744	151
QUINT-UPS/24DC/24DC/5	2320212	274	SVP 2E-110AC	2765534	168	TTC-6-3-HF-F-M-EX-24DC-UT-I	2906823	156			
QUINT4-BUFFER/24DC/20	2907913	295	SVP 3E-110AC	2765521	168	TTC-6-3-HF-M-12DC-PT-I	2906732	150			
QUINT4-BUFFER/24DC/40	2908283	295	SZS 0,6X3,5	1205053	326	TTC-6-3-HF-M-12DC-UT-I	2906721	150			
QUINT4-CAP/24DC/10/8KJ	2320571	297				TTC-6-FMRS-PT	2907811	103			
QUINT4-CAP/24DC/5/4KJ	2320539	296				TTC-6-FMRS-UT	2907810	103			
QUINT4-DIODE/12-24DC/2X20/1X40	2907719	264				TTC-6-GDTC-110AC-PT-I	2908661	127			
QUINT4-DIODE/48DC/2X20/1X40	2907720	265	TAE-TRAB FM-NFN-AP	2749628	165	TTC-6-GDTC-110AC-UT-I	2908644	127	UC-TM 6 GN	0818360	197
QUINT4-PS/1AC/24DC/10	2904601	206	TCP 0,1A	0712107	335	TTC-6-GDTC-24AC-PT-I	2908680	127	UK 6-FS/C	3118203	334
QUINT4-PS/1AC/24DC/20	2904602	207	TCP 0,25A	0712123	335	TTC-6-GDTC-24AC-UT-I	2908642	127	UK 6-FS/C-LED12	3001925	334
QUINT4-PS/1AC/24DC/5	2904600	206	TCP 0,5A	0712152	335	TTC-6-GDTC-24AC-PT-I	2908682	127	UK 6-FS/C-LED24	3001938	334
QUINT4-PS/3AC/24DC/10	2904621	208	TCP 1A	0712194	335	TTC-6-GDTC-24AC-UT-I	2908645	127	UNO-DIODE/5-24DC/2X10/1X20	2905489	267
QUINT4-PS/3AC/24DC/20	2904622	208	TCP 2A	0712217	335	TTC-6-GDTC-60AC-PT-I	2908663	127	UNO-PS/1AC/ 5DC/ 25W	2904374	230
QUINT4-PS/3AC/24DC/5	2904620	208	TCP 3A	0712233	335	TTC-6-GDTC-60AC-UT-I	2908646	127	UNO-PS/1AC/ 5DC/ 40W	2904375	230
QUINT4-S-ORING/12-24DC/1X40	2907752	262	TCP 4A	0712259	335	TTC-6-GDTC-60AC-PT-I	2908729	124	UNO-PS/1AC/12DC/ 30W	2902998	229
QUINT4-S-ORING/12-24DC/1X40/+	2907753	263	TCP 5/DC32V	0700005	334	TTC-6-GDTC-60AC-UT-I	2908729	124	UNO-PS/1AC/12DC/ 55W	2902999	229
QUINT4-UPS/1AC/1AC/1KVA	2320283	281	TCP 6A	0712275	335	TTC-6-MOV-C-120AC-PT-I	2906840	126	UNO-PS/1AC/12DC/100W	2902997	229
			TCP 7,5/DC32V	0700007	334	TTC-6-MOV-C-120AC-UT-I	2906854	126	UNO-PS/1AC/15DC/ 55W	2903001	231
			TCP 8A	0712291	335	TTC-6-MOV-C-24DC-UT-I	2906837	126	UNO-PS/1AC/15DC/100W	2903002	231
			TCP 10/DC32V	0700010	334	TTC-6-MOV-C-48DC-PT-I	2906855	126	UNO-PS/1AC/15DC/30W	2903000	231
			TCP 10A	0712314	335	TTC-6-MOV-C-48DC-UT-I	2906838	126	UNO-PS/1AC/24DC/ 30W	2902991	226
			TCP 15/DC32V	0700015	334	TTC-6-MOV-C-60DC-PT-I	2906857	126	UNO-PS/1AC/24DC/ 60W	2902992	226
			TCP 20/DC32V	0700020	334	TTC-6-MOV-C-60DC-UT-I	2906839	126	UNO-PS/1AC/24DC/100W	2902993	227
			TCP 25/DC32V	0700025	334	TTC-6-MOV-D-24DC-PT-I	2906859	126	UNO-PS/1AC/24DC/150W	2904376	227
			TCP 30/DC32V	0700030	334	TTC-6-MOV-D-24DC-UT-I	2906841	126	UNO-PS/1AC/24DC/240W	2904372	227
			TCP 40/DC32V	0700040	334	TTC-6-TVSD-C-12DC-PT-I	2906847	124	UNO-PS/1AC/24DC/90W/C2LPS	2902994	228
			TMC 1 F1 100 0,2A	0914015	333	TTC-6-TVSD-C-12DC-UT-I	2906829	124	UNO-PS/1AC/48DC/ 60W	2902995	232
			TMCP CONNECT LR	0916592	324	TTC-6-TVSD-C-24DC-PT-I	2906848	124	UNO-PS/1AC/48DC/100W	2902996	232
			TMCP SB	0916602	324	TTC-6-TVSD-C-24DC-UT-I	2906831	124	UNO-PS/2AC/24DC/90W/C2LPS	2904371	228
			TMCP SOCKET M	0916589	324	TTC-6-TVSD-C-48DC-PT-I	2906849	124	UNO-PS/350-900DC/24DC/60W	2906300	233
			TRIO-PS-2G/1AC/12DC/10	2903158	225	TTC-6-TVSD-C-48DC-UT-I	2906832	124	UNO-UPS/24DC/24DC/60W	2905907	299
			TRIO-PS-2G/1AC/12DC/5/C2LPS	2903157	224	TTC-6-TVSD-C-60DC-PT-I	2906850	124	UPS-BAT/LHON/24DC/120WH	2320351	285
			TRIO-PS-2G/1AC/24DC/10	2903149	220	TTC-6-TVSD-C-60DC-UT-I	2906833	124	UPS-BAT/LHON/24DC/924WH	2908232	285
			TRIO-PS-2G/1AC/24DC/10/B+D	2903145	221	TTC-6-TVSD-D-24DC-PT-I	2906851	125	UPS-BAT/VRLA-WTR/24DC/13AH	2320416	288
			TRIO-PS-2G/1AC/24DC/20	2903151	221	TTC-6-TVSD-D-24DC-UT-I	2906834	125	UPS-BAT/VRLA-WTR/24DC/26AH	2320429	288
			TRIO-PS-2G/1AC/24DC/3/C2LPS	2903147	218	TTC-6-TVSD-D-48DC-PT-I	2906852	125	UPS-BAT/VRLA/24DC/1.3AH	2320296	286
			TRIO-PS-2G/1AC/24DC/5	2903148	219	TTC-6-TVSD-D-48DC-UT-I	2906835	125	UPS-BAT/VRLA/24DC/12AH	2320322	287
			TRIO-PS-2G/1AC/24DC/5/B+D	2903144	219	TTC-6-TVSD-D-60DC-PT-I	2906853	125	UPS-BAT/VRLA/24DC/3.4AH	2320306	286
			TRIO-PS-2G/1AC/48DC/10	2903160	225	TTC-6-TVSD-D-60DC-UT-I	2906836	125	UPS-BAT/VRLA/24DC/38AH	2320335	287
			TRIO-PS-2G/1AC/48DC/5	2903159	225	TTC-6P-1X2-12DC-PT-I	2908193	92	UPS-BAT/VRLA/24DC/7.2AH	2320319	287
			TRIO-PS-2G/3AC/24DC/10	2903154	223	TTC-6P-1X2-12DC-UT-I	2908192	92	UPS-CAP/24DC/10A/10KJ	2320377	284
			TRIO-PS-2G/3AC/24DC/20	2903155	223	TTC-6P-1X2-24DC-PT-I	2906815	92	UPS-CAP/24DC/20A/20KJ	2320380	284
			TRIO-PS-2G/3AC/24DC/40	2903156	223	TTC-6P-1X2-24DC-UT-I	2906809	92	UPS-CONF	2320403	290
			TRIO-PS-2G/3AC/24DC/5	2903153	222	TTC-6P-1X2-48DC-PT-I	2908195	92	UT 6-TMC M 0,5A	0916603	332
			TRIO-PS/600DC/24DC/20	2866530	215	TTC-6P-1X2-48DC-UT-I	2908194	92	UT 6-TMC M 10A	0916610	332
			TRIO-UPS-2G/1AC/1AC/120V/750VA	2905908	282	TTC-6P-1X2-F-12DC-PT-I	2908198	93	UT 6-TMC M 12A	0916611	332
			TRIO-UPS-2G/1AC/1AC/230V/750VA	2905909	282	TTC-6P-1X2-F-12DC-UT-I	2908196	93	UT 6-TMC M 15A	0916612	332
			TRIO-UPS/1AC/24DC/ 5	2866611	300	TTC-6P-1X2-F-48DC-PT-I	2908200	93	UT 6-TMC M 16A	0916613	332
			TRIO-DIODE/12-24DC/2X10/1X20	2907380	266	TTC-6P-1X2-F-48DC-UT-I	2908199	93	UT 6-TMC M 1A	0916604	332
			TRIO-DIODE/12-24DC/2X20/1X40	2907379	267	TTC-6P-1X2-F-M-24DC-PT-I	2906790	93	UT 6-TMC M 2A	0916605	332
			TT-D-STTCCO-BK	2858894	186	TTC-6P-1X2-F-M-24DC-UT-I	2906781	93	UT 6-TMC M 4A	0916606	332
			TT-ST-M-SFP-24AC	2858946	186	TTC-6P-1X2-M-24DC-PT-I	2906750	92	UT 6-TMC M 5A	0916607	332
			TTC-3-1X2-24DC-PT	2907325	95	TTC-6P-1X2-M-24DC-UT-I	2906738	92	UT 6-TMC M 6A	0916608	332
			TTC-3-2X1-24DC-PT	2907326	109	TTC-6P-1X2-M-EX-24DC-UT-I	2906824	128	UT 6-TMC M 8A	0916609	332
			TTC-3-LCP	2908843	95	TTC-6P-2-HC-24DC-PT-I	2906817	106	UWA 180	2901664	269
			TTC-6-1X2-24DC-PT	2906804	94	TTC-6P-2-HC-24DC-UT-I	2906811	106	UWA 182/52		

Type	Order No.	Page	Type	Order No.	Page
			VAL-MS-T1/T2 335/12.5/3+1-FM	2800183	36
			VAL-MS-T1/T2 335/12.5/4+0	2800645	36
			VAL-MS-T1/T2 335/12.5/4+0-FM	2800644	36
			VAL-MS-T1/T2 48/12.5 ST	2801242	38
<b>V</b>					
VAL-CP-350-ST-GY	2882718	66	VAL-MS-T1/T2 48/12.5/1+0	2801241	38
VAL-CP-MCB-1S-350/40/FM	2882763	66	VAL-MS-T1/T2 48/12.5/1+0-FM	2801240	38
VAL-CP-MCB-3C-350/40/FM	2882776	66	VAL-MS-T1/T2 48/12.5/1+1/1U/FM	2909629	39
VAL-CP-MCB-3S-350/40/FM	2882750	66	VAL-MS-T1/T2 48/12.5/1+1V	2801532	38
			VAL-MS-T1/T2 48/12.5/1+1V-FM	2801533	38
VAL-CP-MOSO 60-3C-FM	2804416	68	VAL-MS-T1/T2 48/12.5/O	2906281	39
VAL-CP-MOSO 60-3S-FM	2804403	68	VAL-MS-T1/T2 48/12.5/O-FM	2906282	39
VAL-CP-N/PE-350-ST-GY	2882734	66	VAL-MS-T1/T2 600DC-PV-ST	2801165	41
VAL-CP-RCD-3S/40/0.03	2882802	67			
			VAL-MS-T1/T2 600DC-PV/2+V	2801163	41
VAL-CP-RCD-3S/40/0.3/SEL	2808001	67	VAL-MS-T1/T2 600DC-PV/2+V-FM	2801164	41
VAL-MB-T1/T2 1000DC-PV/2+V	2905639	41	VAL-MS-T1/T2 BE/O	2905650	39
VAL-MB-T1/T2 1000DC-PV/2+V-FM	2905638	41	VAL-MS-T1/T2 BE/O-FM	2905652	39
VAL-MB-T1/T2 1500DC-PV/2+V	2905641	41			
			VAL-MS/1+1-BE	2920528	58
VAL-MB-T1/T2 1500DC-PV/2+V-FM	2905640	41	VAL-MS/1+1-BE/FM	2920531	58
VAL-MB-T1/T2 600DC-PV/2+V	2906293	41	VAL-MS/2+0-BE	2804584	58
VAL-MB-T1/T2 600DC-PV/2+V-FM	2906292	41	VAL-MS/2+0-BE/FM	2805321	58
VAL-MB-T2 1500DC-PV/2+V	2905647	64			
			VAL-MS/3+0-BE	2881816	59
VAL-MB-T2 1500DC-PV/2+V-FM	2905646	64	VAL-MS/3+0-BE/FM	2881803	59
VAL-MS 60 ST	2807573	58	VAL-MS/3+1-BE	2838885	58
VAL-MS 1000DC-PV-ST	2800624	65	VAL-MS/3+1-BE/FM	2838898	58
VAL-MS 1000DC-PV/2+V	2800628	65			
			VAL-MS/3+1-BE/FM-UD	2858674	59
VAL-MS 1000DC-PV/2+V-FM	2800627	65	VAL-MS/4+0-BE/FM RN.	2906484	59
VAL-MS 120 ST	2807586	58	VAL-SEC-T2-120DC-P	2907878	50
VAL-MS 230 IT ST	2807599	59	VAL-SEC-T2-175-P	2905355	48
VAL-MS 230 ST	2798844	59			
			VAL-SEC-T2-1S-175-FM	2905348	49
VAL-MS 230-UD-ST	2858962	59	VAL-SEC-T2-1S-350	2905341	47
VAL-MS 230/1+1	2804429	53	VAL-SEC-T2-1S-350-FM	2905333	47
VAL-MS 230/1+1-FM	2804432	53	VAL-SEC-T2-1S-350VF-FM	2909592	47
VAL-MS 230/3+1	2838209	52			
			VAL-SEC-T2-2+0-120DC-FM	2907874	50
VAL-MS 230/3+1 FM	2838199	52	VAL-SEC-T2-2+0-220DC-FM	2907875	51
VAL-MS 320 ST	2838843	60	VAL-SEC-T2-2+0-380DC-FM	2907876	51
VAL-MS 320-UD ST	2858315	61	VAL-SEC-T2-2+0-48DC-FM	2907865	50
VAL-MS 320/1+1	2804380	53			
			VAL-SEC-T2-220DC-P	2907879	51
VAL-MS 320/1+1-FM	2804393	53	VAL-SEC-T2-2C-175-FM	2905350	49
VAL-MS 320/3+0	2920230	53	VAL-SEC-T2-2C-350	2905342	47
VAL-MS 320/3+0-FM	2920243	53	VAL-SEC-T2-2C-350-FM	2905337	47
VAL-MS 320/3+1	2859178	52			
			VAL-SEC-T2-2S-175-FM	2905351	49
VAL-MS 320/3+1-FM	2859181	52	VAL-SEC-T2-2S-350	2905343	47
VAL-MS 320/3+1/FM-UD	2856689	52	VAL-SEC-T2-2S-350-FM	2905338	47
VAL-MS 350 VF ST	2856595	63	VAL-SEC-T2-350-P	2905346	42
VAL-MS 350 VF/3+1	2858755	54			
			VAL-SEC-T2-350VF-P	2909596	46
VAL-MS 350 VF/FM	2856579	54	VAL-SEC-T2-380DC-P	2907880	51
VAL-MS 350VF	2856582	54	VAL-SEC-T2-3C-175-FM	2905353	48
VAL-MS 350VF/3+1-FM	2858632	54	VAL-SEC-T2-3C-350	2905344	46
VAL-MS 4+V/BE/FM	2908725	65			
			VAL-SEC-T2-3C-350-FM	2905339	46
VAL-MS 400 ST	2816399	61	VAL-SEC-T2-3C-350VF-FM	2909591	46
VAL-MS 500 ST	2807609	61	VAL-SEC-T2-3C-440-FM	2909968	45
VAL-MS 580-ST	2920434	62	VAL-SEC-T2-3S-175-FM	2905354	48
VAL-MS 60	2868020	55			
			VAL-SEC-T2-3S-350	2905345	46
VAL-MS 60/FM	2868033	55	VAL-SEC-T2-3S-350-FM	2905340	46
VAL-MS 600DC-PV-ST	2800623	65	VAL-SEC-T2-3S-350/40	2909637	45
VAL-MS 600DC-PV/2+V	2800642	65	VAL-SEC-T2-3S-350/40-FM	2909635	45
VAL-MS 600DC-PV/2+V-FM	2800641	65			
			VAL-SEC-T2-3S-350VF-FM	2909590	46
VAL-MS 75 VF ST	2805318	62	VAL-SEC-T2-440-P	2909969	45
VAL-MS 750/30-ST	2920256	56	VAL-SEC-T2-48DC-P	2907877	50
VAL-MS 750/30/3+0	2920269	56	VAL-SEC-T2-N/PE-175-P	2905356	48
VAL-MS 750/30/3+0-FM	2920272	56			
			VAL-SEC-T2-N/PE-264/40-P	2909636	45
VAL-MS 800/30 VF/FM	2805402	56	VAL-SEC-T2-N/PE-350-P	2905347	46
VAL-MS BE	2817741	58	VIP-2/SC/PDM-2/16	2315256	268
VAL-MS BE/1+1/1U/FM	2909628	39	VIP-2/SC/PDM-2/24	2315269	268
VAL-MS BE/2+0/1U/FM	2907037	58			
			VIP-2/SC/PDM-2/32	2315272	268
VAL-MS BE/FM	2817738	58	VIP-2/SC/PDM-2/48	2903717	268
VAL-MS-CN 1000DC-PV/4+V-FM	2907820	65	VIP-CAB-FLK16/FR/FR/0,14/0,5M	2900154	100
VAL-MS-T1/T2 1000DC-PV-ST	2801162	41	VIP-CAB-FLK16/FR/FR/0,14/1,0M	2900155	100
VAL-MS-T1/T2 1000DC-PV/2+V	2801160	41			
			VIP-CAB-FLK16/FR/FR/0,14/2,0M	2900156	100
VAL-MS-T1/T2 1000DC-PV/2+V-FM	2801161	41			
VAL-MS-T1/T2 175/12.5 ST	2800676	37			
VAL-MS-T1/T2 175/12.5/1+1-FM	2800674	37			
VAL-MS-T1/T2 175/12.5/3+0-FM	2800672	37			
VAL-MS-T1/T2 335/12.5 ST	2800190	36	ZB 12:UNPRINTED	0812120	197
VAL-MS-T1/T2 335/12.5/1+0	2801041	37	ZBN 18 CUS	0825059	197
VAL-MS-T1/T2 335/12.5/1+0-FM	2801042	37			
VAL-MS-T1/T2 335/12.5/1+1	2800187	37			
VAL-MS-T1/T2 335/12.5/1+1-FM	2800186	37			
VAL-MS-T1/T2 335/12.5/3+0	2800189	37			
VAL-MS-T1/T2 335/12.5/3+0-FM	2800188	37			
VAL-MS-T1/T2 335/12.5/3+1	2800184	36			

**Z**



For up-to-date modifications or supplements  
to the catalog contents, please visit:  
**[phoenixcontact.net/webcode/#0132](http://phoenixcontact.net/webcode/#0132)**

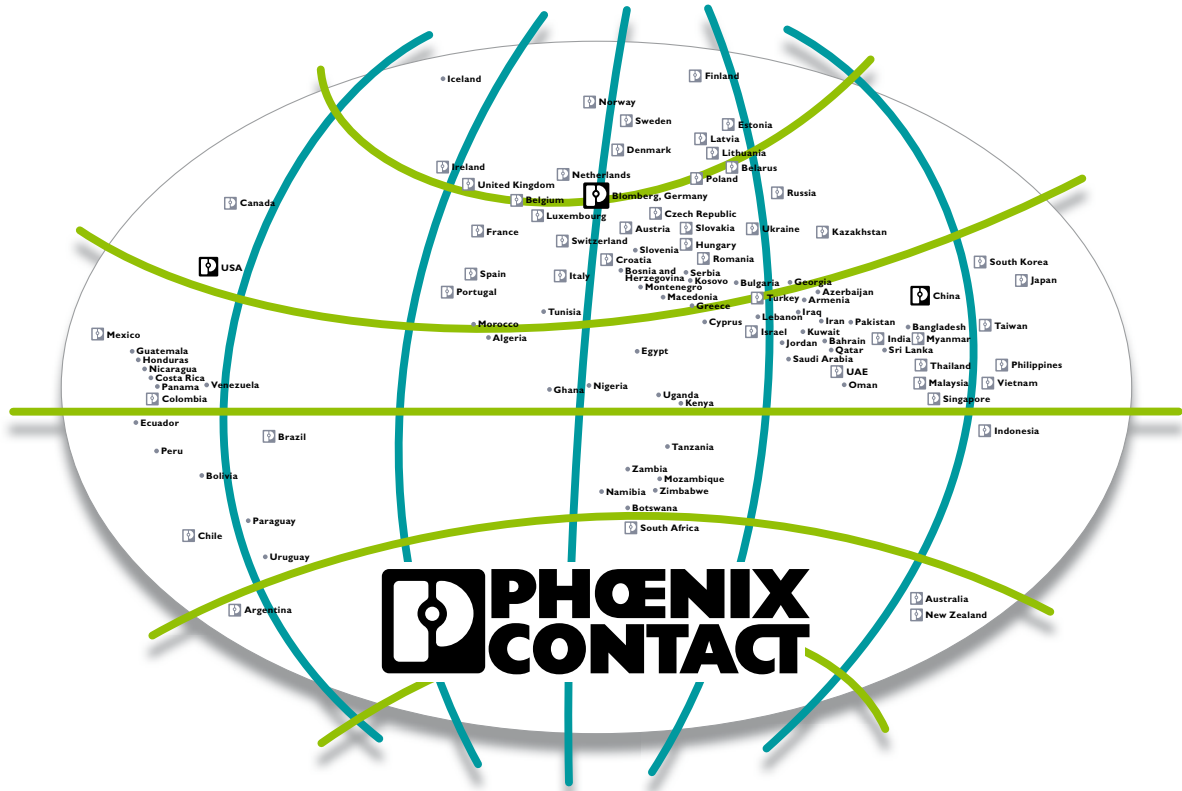

PROUDLY DISTRIBUTED BY



03 5278 8222

[sales@factorycontrols.com.au](mailto:sales@factorycontrols.com.au)

[www.factorycontrols.com.au](http://www.factorycontrols.com.au)

65 Douro Street, North Geelong Victoria 3215



INSPIRING INNOVATIONS